

Palladium Books® Presents:

# Rifts® Japan

World Book Eight

By Kevin Siembieda

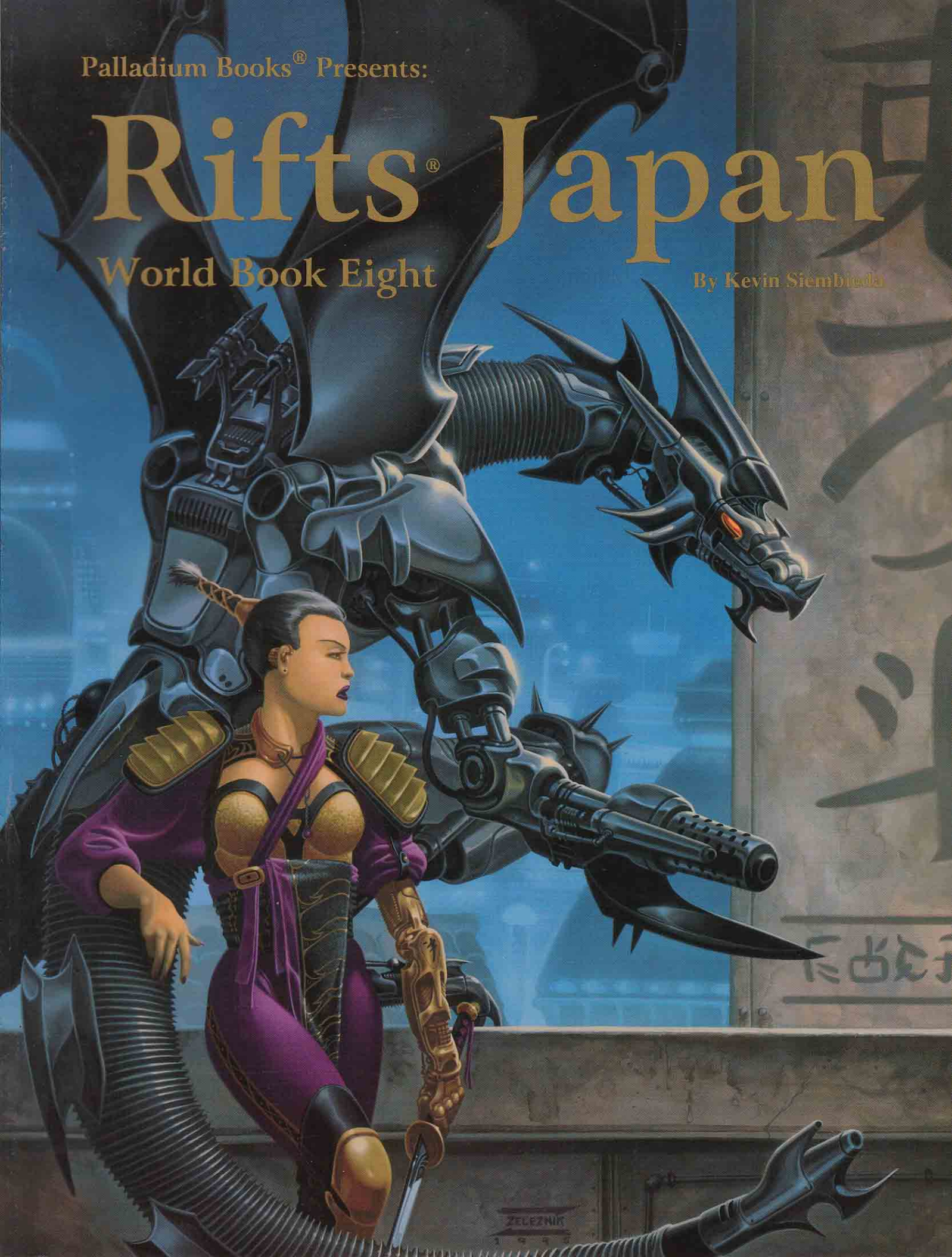

ZELEZNIK  
1994

# Warning!

## Violence and the Supernatural

**The fictional World of Rifts®** is violent, deadly and filled with supernatural monsters. Other dimensional beings, often referred to as "demons," torment, stalk and prey on humans. Other alien life forms, monsters, gods and demigod, as well as magic, insanity, and war are all elements in this book.

Some parents may find the violence and supernatural elements of the game inappropriate for young readers/players. We suggest parental discretion.

Please note that none of us at Palladium Books® condone or encourage the occult, the practice of magic, the use of drugs, suicide or violence.

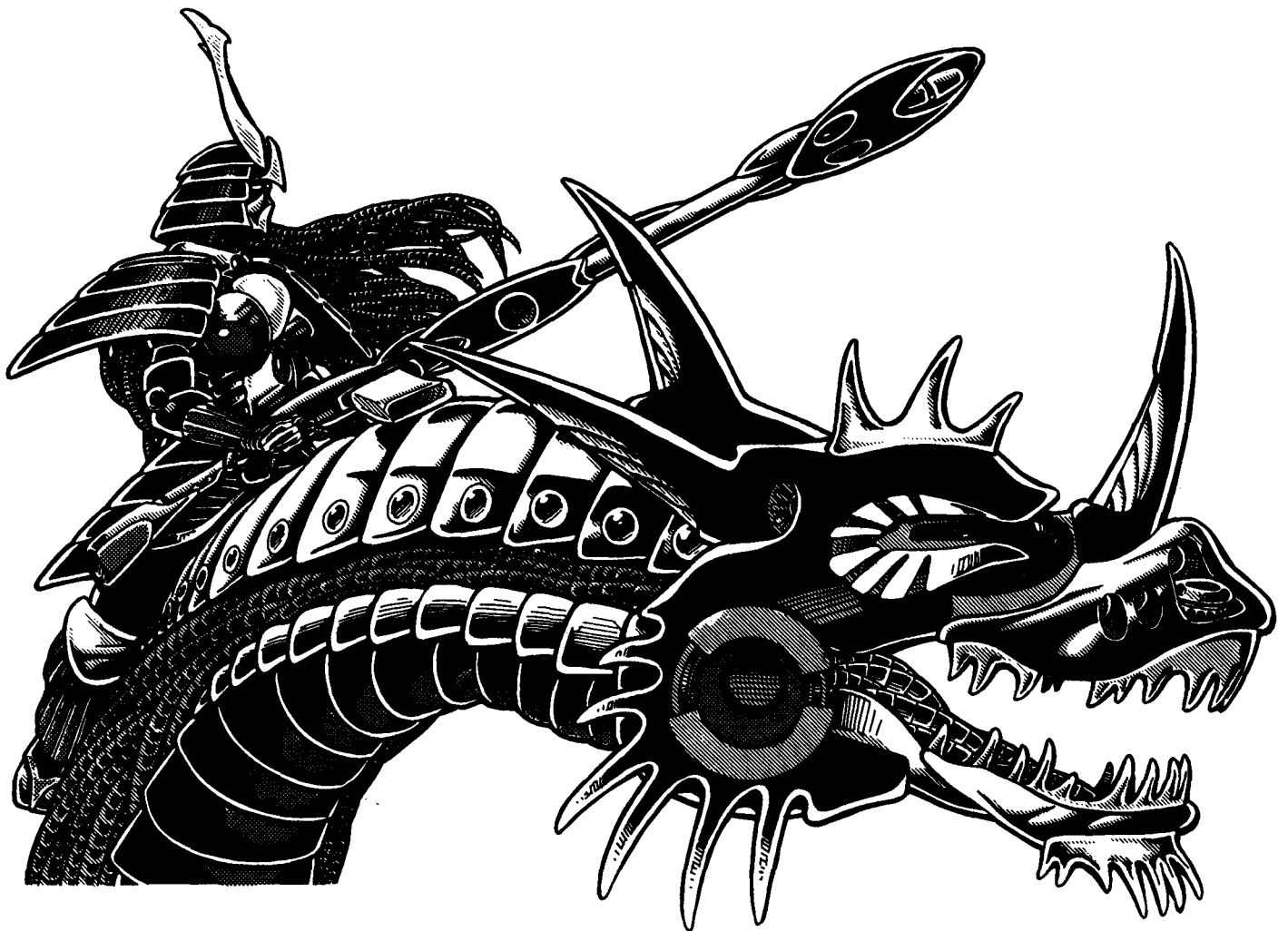

A supplement for the Rifts® RPG.

Compatible with the entire Palladium Books® Megaverse®!

**Dedicated to Maryann, who has the spirit of a warrior and the tenacity of an oni. And to Erick Wujcik and Julius Rosenstein the only samurai I have ever known.**

*Kevin Siembieda*

**Third Printing — May, 1999**

Copyright © 1995 Palladium Books Inc.

Copyright © 1995 by Kevin Siembieda

All rights reserved under the Universal Copyright Convention, World Wide. No part of this book may be reproduced in part or whole, in any form or by any **means**, without permission from the publisher, except for brief quotes for use in reviews. All incidents, situations, institutions, governments and people are **fictional** and any **similarity**, without satiric intent, of characters or persons living or dead, is strictly coincidental.

Rifts®, Palladium Books®, and Megaverse® are registered trademarks owned and licensed by Kevin Siembieda and Palladium Books Inc.

Nightspawn, Heroes Unlimited, **Triax**, Mindwerks, NGR, **Splugorth**, **Kittani**, Coalition States, Erin Tarn, **Cyberoid**, Dragon Borgs, and other names and titles are trademarks owned by Kevin Siembieda and Palladium Books Inc.

**World Book Eight: Rifts® Japan™** is published by Palladium Books Inc., 12455 Universal Drive, Taylor, MI 48180. Printed in the USA.

**Palladium Books® Presents:**

# Rifts Japan™

**World Book Eight**

---

Written By: **Kevin Siembieda**

Contributing Writers: **Patrick Nowak**

Additional Text: **C.J. Carella**

Senior Editor: **Alex Marciniszyn**

Editors: **James A. Osten**  
**Kevin Kirsten**  
**Julius Rosenstein**

Special Consultant: **Erick Wujcik**

Cover Painting: **John Zeleznik**

Interior Artists: **Vince Martin**  
**Wayne Breaux**  
**Randy Post**  
**Kevin Siembieda**

Art Direction & Keylining: **Kevin Siembieda**

Typography: **Maryann Siembieda**  
**Mike O'Connor**

**Special Thanks to** Pat Nowak who worked his heart out on this book only to have me rewrite 80% of it. This lad's got lots of talent and is willing to do whatever is necessary to make a book sing.

Erick Wujcik for his suggestions and for sharing his of his vast knowledge about the Japanese culture, people, traditions, myths, and history, as well as generous access to his extensive library of books on the Orient.

Also to Julius for his input, knowledge and help. C.J. for kicking in when I needed him most. John Zeleznik for a dynamic cover painting. Vince Martin for some truly outstanding designs and artwork. Wayne Breaux and Randy Post for their bold, artistic contributions. And to Maryann, Alex, Jim, Kev and the usual hard working demon quellers at Palladium Books for their heartfelt efforts (not to mention a special guest appearance by Tom Bartold assisting on some computer and business details).

*Kevin Siembieda*



# Contents

## Endless Possibilities

The Japanese Islands . . . . . 9

## The New Empire . . . . . 11

History & Backround . . . . . 11

Kyoto . . . . . 12

Traditionalism of the New Empire . . . . . 12

Map of Rifts Japan . . . . . 13

A Caste Society . . . . . 14

The Average Peasant or Eta . . . . . 15

Industry & Technology . . . . . 15

The Military & The Law . . . . . 15

Weapons Restrictions . . . . . 15

Foreign Realations . . . . . 16

## Other Places in and Around Japan . . . . . 17

### Takamatsu . . . . . 17

Society . . . . . 18

Ichto Province . . . . . 18

Foreign Relations . . . . . 19

Villages of the Ichto Province . . . . . 20

### Otomo Shogunate . . . . . 21

The Mad Scheme . . . . . 21

Foeign Relations . . . . . 22

H-Brand Corporation . . . . . 23

### Other Place of Note . . . . . 24

Other Islands of Japan . . . . . 24

The Russian Coast . . . . . 24

Mainland China . . . . . 26

Korea . . . . . 26

Taiwan . . . . . 26

Philippines . . . . . 26

The Japanese Triangle . . . . . 26

Map of Ley lines of Japan . . . . . 27

## Kyoto Millennium Tree . . . . . 28

The Average Millennium Tree . . . . . 29

Means of Defense . . . . . 30

Energy Eruption . . . . . 30

Protectors & Inhabitants . . . . . 30

Millennium Ley Line Storms . . . . . 30

## Powers of the Millennium Tree . . . . . 32

Bark Body Armor . . . . . 32

Bark Sheild . . . . . 32

Camoflaug . . . . . 32

Control over Ley Lines, Storms & Rifts . . . . . 32

Control over Normal Weather . . . . . 32

Leaf: Blanket of Healing . . . . . 32

Leaf Body Armor . . . . . 32

Ley Line Teleportation . . . . . 33

Power to Heal . . . . . 33

Purify Food & Water . . . . . 33

Resurrection & Restoration . . . . . 33

Sixth Sense Warning . . . . . 33

Visions and Dreams . . . . . 33

Millennium Tree Magic Wands . . . . . 33

Millennium Tree Staves . . . . . 35

Corrupted Wands & Staves . . . . . 36

## Enchanted Items . . . . . 37

Elemental Shuriken . . . . . 37

TW Power Shuriken . . . . . 37

TW Fire-Breathing Arquebus . . . . . 37

Magic Powder Grenades . . . . . 38

Singing Arrows (Nari-Kabura) . . . . . 38

Tanto of Hellish Poison . . . . . 38

"Ten Thousand Strength" Nunchakus . . . . . 38

Whirlwind Naginata . . . . . 38

Zen Master's Bows . . . . . 38

## Greater & Greatest Daisho Rune Swords . . . . . 39

Daisho of the Relentless Warrior . . . . . 39

Daisho of the Storm . . . . . 40

Ghostly Katana of Soul Slaying . . . . . 40

## Magical items . . . . . 40

Bottomless Purse (Kanebukoro) . . . . . 40

Fan of the Forest Wind . . . . . 41

Hat of Invisibility (Kakuregasa) . . . . . 41

Heavenly Speaking Flute . . . . . 41

Holy Incense Burner . . . . . 41

Lantern of Protection . . . . . 42

Living Kani Statues . . . . . 42

Mirror of True-Seeing . . . . . 42

Powder of the Heavenly Winds (Kamikaze) . . . . . 42

Tatoos of Strength . . . . . 43

## New Empire & Traditional O.C.C.'s . . . . . 43

Traditional Samurai Warrior O.C.C. . . . . 43

Bushido Code . . . . . 44

The Living Samurai Sword . . . . . 44

Hand to Hand: Zanji Shinjinken-Ryo . . . . . 47

Samurai Family Backround . . . . . 47

Female Samurai . . . . . 49

Ronin O.C.C. . . . . 49

Mystic Ninja O.C.C. . . . . 51

Hand to Hand: Ninjitsu/Tai-Jutsu . . . . . 53

Traditional Ninja Equipment . . . . . 54

Ninja Gimmick Clothing . . . . . 54

Bishamon Fighting Monk O.C.C. . . . . 55

Sohei Warrior Monk O.C.C. . . . . 58

Female Sohei — Warrior Nuns . . . . . 60

Yamabushi Mountain Priest O.C.C. . . . . 60

Demon Queller O.C.C. . . . . 64

Tengu R.C.C. . . . . 66

Hand to Hand: Teng-jutsu . . . . . 69

## The Republic of Japan . . . . . 70

History . . . . . 70

People Out of Time . . . . . 71

Government . . . . . 71

Industry . . . . .	71	Traditional Japanese S.D.C. Weapons . . . . .	118
The Cities . . . . .	72	AT-N20 Neural Stick . . . . .	120
Education . . . . .	73	AT-AAD Grenade or Missile . . . . .	120
Human Augmentation in the Republic . . . . .	74	AT-23 Plasma <b>Thrower</b> . . . . .	121
M.O.M./Crazies & Jucier <b>Augmentation</b> . . . . .	74	<b>Energy Pistols</b> . . . . .	<b>121</b>
Genetic Engineering & <b>Cloning</b> . . . . .	75	AT-6 "Mini" Laser Pistol . . . . .	121
The Law & Law <b>Enforcement</b> . . . . .	75	AT-8 Laser Pistol . . . . .	121
The Military . . . . .	75	At-20 "Sharpshot" Police Special <b>Laser</b> . . . . .	122
Glitter Force . . . . .	76	AT-30 Combat laser Pistol . . . . .	122
The Navy . . . . .	76	<b>AT-130 Particle Beam Pistol</b> . . . . .	122
D-Bees of the Republic of <b>Japan</b> . . . . .	76	<b>H-10 Combat Laser Pistol</b> . . . . .	122
Earth for Humanity . . . . .	76	<b>H-13 Ion Pulse Pistol</b> . . . . .	123
Foreign Relations . . . . .	76	<b>Energy Rifles &amp; Rail Guns</b> . . . . .	<b>123</b>
<b>Character Classes</b> . . . . .	<b>78</b>	AT-23 Police Stun Rifle . . . . .	123
Cyberoid O.C.C. . . . .	78	AT-84 "Sharpshot" Laser <b>Rifle</b> . . . . .	124
Cyber-Samurai O.C.C. . . . .	80	AT-88 Combat Laser Rifle . . . . .	125
Tech-Ninja O.C.C. . . . .	82	AT-30 Particle Beam Rifle . . . . .	125
Ninja-Jucier O.C.C. . . . .	84	ATU-80 Underwater Assault Rifle . . . . .	125
Ninja Crazy O.C.C. . . . .	86	<b>H-15 "Scattergun" Shotgun</b> . . . . .	126
Ninja 'Borg O.C.C. . . . .	88	<b>AT-600 Rail Gun</b> . . . . .	127
Ninja <b>Techno-Wizard</b> O.C.C. . . . .	89	AT-1200 "Super Rail Gun" . . . . .	127
Samas Samurai Pilot O.C.C. . . . .	91	H-600 Rail Gun . . . . .	127
Infantrymen O.C.C. . . . .	92	ARC-2 "Nighthawk" Defense System . . . . .	128
Robot Pilot O.C.C. . . . .	92	<b>Explosives</b> . . . . .	<b>129</b>
Glitter Force Trooper O.C.C. . . . .	93	Missiles . . . . .	129
Police Officer O.C.C. . . . .	94	Torpedoes . . . . .	129
Other O.C.C.'s . . . . .	95	AT-D10 Satchel Charge . . . . .	129
<b>Cyborgs of Japan</b> . . . . .	<b>96</b>	Hand Grenades . . . . .	129
Cybernetic & Bionic <b>Conversion</b> . . . . .	96	AT-25 Pump Grenade <b>launcher</b> . . . . .	130
Japanese Bionic <b>Conversion</b> . . . . .	96	CC-26 Bomb <b>Detector</b> . . . . .	130
Partial Conversion . . . . .	96	<b>Land Mines</b> . . . . .	<b>131</b>
Full Bionic Conversion . . . . .	96	AT-250 Anti-Personnel Mine . . . . .	131
Republic Cyborg Soldier O.C.C. . . . .	97	AT-D52 "Bullet" Anti-Personnel Mine . . . . .	131
Decommissioned <b>Cyborgs</b> . . . . .	98	AT-D54 Anti-Armor Mine . . . . .	131
Life Expectancy . . . . .	98	<b>Power Armor</b> . . . . .	<b>132</b>
Laws Governing Cybernetic Systems . . . . .	99	Japanese Samas Power Armor . . . . .	132
<b>Dragon 'Borgs</b> . . . . .	<b>101</b>	ArmaTech "Samurai Class" <b>SAMAS</b> Power Armor . . . . .	134
Wing Blade 'Borg . . . . .	101	Glitter Boy Power Armor . . . . .	135
Tsunami 'Borg . . . . .	102	<b>New Glitter Boys</b> . . . . .	<b>137</b>
"Imperial" Combat 'Borg . . . . .	105	"Point" Glitter Boy . . . . .	137
"Flame Cloud" Attack 'Borg . . . . .	107	"Hawkeye" Glitter Boy . . . . .	140
<b>Cybernetics &amp; Bionics</b> . . . . .	<b>109</b>	Optional GB Weapon Systems . . . . .	142
Cybernetic Implants & Enhancements . . . . .	109	ATPA-85 . . . . .	143
Bionic Weapons & Tools . . . . .	111	H-Brand "Ninjabot" . . . . .	144
<b>High-Tech Weapons</b> . . . . .	<b>114</b>	<b>Ichto Power Armor &amp; Bots</b> . . . . .	<b>146</b>
ArmaTech Industries . . . . .	114	IPA-40 Dai-Katana Bugei . . . . .	146
H-Brand . . . . .	115	IPA-45 Ikusa (or "Warrior") . . . . .	148
<b>Odds &amp; Ends</b> . . . . .	<b>115</b>	IPA-50 "Grenadier" . . . . .	150
SNARLS Sensor System . . . . .	116	IPA-60 Tazu-Tengu Power Armor . . . . .	153
Armed Forces Personnel <b>Backpack</b> . . . . .	116	IPA-62 "Super Tengu" . . . . .	155
Energy Clips . . . . .	117	IPA-70 Mizu Mi . . . . .	156
<b>Vibro-Blades</b> . . . . .	<b>117</b>	<b>Robots</b> . . . . .	<b>158</b>
Bows & Arrows . . . . .	118	AT-1053 Ka-Kuma "Metal Bear" . . . . .	158
		AT-1063 Hi-Tora "Fire Tiger" . . . . .	161
		IR-2015 Kani "Crab Walker" . . . . .	164

IR-2020 Wrecker	165
IR-2040 Destroyer	168
IR-2050 Apocalypse	170
IR-2060 Banshee	173
IR-2070 Gemini	176
IR-4000 Tatsu "Dragon"	178

<b>Body Armor</b>	<b>181</b>
KM-200 Jet Pack	181
<b>Republic of Japan Military &amp; Police Armor</b>	<b>182</b>
AT-A11 Kuru Street Armor (Police)	182
AT-A14 Infantry "Trooper" Body Armor	183
AT-A15 marine Heavy Combat Body Armor	183
<b>Ichto &amp; H-Brand Armor</b>	<b>184</b>
IA-100 Infiltrator Body Armor	184
IA-130 "Sumo" Body Armor	185
HA-4 & 5 "Hiker" Body Armor	185
HA-6 & 7 "Frontiersman" Body Armor	186
Ha-20 Jucier Environmental Armor	186

**Japanese Skills**..... 187

<b>Hand to Hand Combat</b>	<b>190</b>
Basic Martial Arts: Judo	193
Aikido	193
Jujitsu	193
Karate	194
Kendo	194
Other Forms of Modern Combat	194

**Mystic Martial Arts Powers**..... 195

<b>Arts of Invisibility</b>	<b>195</b>
Art of Stealth	195
Art of Hiding	195
Art of Evasion	195
Art of Vanishing	195
Art of Disguise	196
Art of Mystic Invisibility	196

**Body Hardening Exercises**..... 196

Stone Ox	196
Combination of Kangeiko & Shocu Geiko	196
Iron hand or Kanshu	196
Chi-Gung Mega-Damage Skin	197
Dam Sum Sing	197
Wrist Hardening	197
Kick Practice or Kagi	197

**Zenjoriki Powers**..... 197

Calm Minds	197
Karumi-Jutsu	197
Two Minds	198
Vibrating Palm	198
Vital Strike or Atemi	198
Withering Flesh Atemi	198

**Monsters of Japan**..... 199

Oni "One Hundred Demons"	199
--------------------------	-----

Tables for Oni Creation	200
Oni R.C.C.	202
Oni Master	203
Oni Mystic	204
Sura-Kappa R.C.C.	205
Goblin	206
Goblin Spider	207

## Quick Find

<b>Body Armor</b>	<b>181</b>
KM-200 Jet Pack	181
<b>Republic of Japan Military &amp; Police Armor</b>	<b>182</b>
AT-A11 Kuru Street Armor (Police)	182
AT-A14 Infantry "Trooper" Body Armor	183
AT-A15 Marine Heavy Combat Body Armor	183
<b>Ichto &amp; H-Brand Armor</b>	<b>184</b>
HA-6 & 7 "Frontiersman" Body Armor	186
HA-4 & 5 "Hiker" Body Armor	185
IA-100 Infiltrator Body Armor	184
HA-20 Jucier Environmental Armor	186
IA-130 "Sumo" Body Armor	185

**Enchanted Items**.....37

Elemental Shuriken	37
Magic Powder Grenades	38
Singing Arrows (Nari-Kabura)	38
Tanto of Hellish Poison	38
"Ten Thousand Strength" Nunchakus	38
TW Power Shuriken	37
TW Fire-Breathing Arquebus	37
Whirlwind Naginata	38
Zen Master's Bows	38

**Greater & Greatest Daisho Rune Swords**.....39

Daisho of the Relentless Warrior	39
Daisho of the Storm	40
Ghostly Katana of Soul Slaying	40

**Magical items**.....40

Bottomless Purse (Kanebukoro)	40
Fan of the Forest Wind	41
Hat of Invisibility (Kakuregasa)	41
Heavenly Speaking Flute	41
Holy Incense Burner	41
Lantern of Protection	42
Living Kani Statues	42
Mirror of True-Seeing	42
Powder of the Heavenly Winds (Kamikaze)	42
Tatoos of Strength	43

**Hand to Hand Skills**

Hand to Hand Combat	190
Basic Martial Arts: Judo	193
Hand to Hand: Aikido	193
Hand to Hand: Jujitsu	193
Hand to Hand: Karate	194

Hand to Hand: Kendo .....	194
Hand to Hand: Ninjitsu/Tai-Jutsu	53
Hand to Hand: Teng-jutsu	69
Hand to Hand: <b>Zanji Shinjinken-Ryo</b>	47
Other Forms of Modern <b>Combat</b> .....	194
<b>High-Tech Weapons</b> .....	<b>114</b>
ArmaTech Industries .....	114
<b>H-Brand</b> .....	<b>115</b>
<b>Odds &amp; Ends</b> .....	<b>115</b>
Armed Forces Personnel <b>Backpack</b> .....	116
AT-AAD Grenade or <b>Missile</b> .....	120
AT-N20 Neural <b>Stick</b> .....	120
AT-23 Plasma Thrower .....	121
Bows & Arrows .....	118
Energy Clips .....	117
SNARLS Sensor System .....	116
Traditional Japanese S D C Weapons .....	118
Vibro-Blades .....	117
<b>Energy Pistols</b> .....	<b>121</b>
AT-30 Combat Laser <b>Pistol</b> .....	122
AT-8 Laser <b>Pistol</b> .....	121
AT-6 "Mini" Laser <b>Pistol</b> .....	121
AT-130 Particle Beam <b>Pistol</b> .....	122
AT-20 "Sharpshot" Police Special <b>Laser</b> .....	122
H-10 Combat Laser <b>Pistol</b> .....	122
H-13 Ion Pulse <b>Pistol</b> .....	123
<b>Energy Rifles &amp; Rail Guns</b> .....	<b>123</b>
AT-88 Combat Laser <b>Rifle</b> .....	125
AT-30 Particle Beam <b>Rifle</b> .....	125
AT-23 Police Stun <b>Rifle</b> .....	123
ARC-2 "Nighthawk" Defense <b>System</b> .....	128
AT-84 "Sharpshot" Laser <b>Rifle</b> .....	124
AT-600 Rail <b>Gun</b> .....	127
AT-1200 "Super Rail <b>Gun</b> " .....	127
ATU-80 Underwater Assault <b>Rifle</b> .....	125
H-15 "Scattergun" <b>Shotgun</b> .....	126
H-600 Rail <b>Gun</b> .....	127
<b>Explosives</b> .....	<b>129</b>
AT-25 Pump Grenade <b>launcher</b> .....	130
AT-D10 Satchel <b>Charge</b> .....	129
CC-26 Bomb <b>Detector</b> .....	130
Hand <b>Grenades</b> .....	129
<b>Missiles</b> .....	129
<b>Torpedoes</b> .....	129
<b>Land Mines</b> .....	<b>131</b>
AT-250 Anti-Personnel <b>Mine</b> .....	131
AT-D54 Anti-Armor <b>Mine</b> .....	131
AT-D52 "Bullet" Anti-Personnel <b>Mine</b> .....	131
<b>Miscellaneous</b>	
Cyborgs of Japan .....	96
Dragon 'Borgs .....	101
Earth for Humanity .....	76
Enchanted <b>Items</b> .....	37
Glitter <b>Force</b> .....	76

Japanese <b>Skills</b> .....	187
Kyoto Millennium <b>Tree</b> .....	28
Laws Governing Cybernetic <b>Systems</b> .....	99
Map of Rifts <b>Japan</b> .....	13
New Glitter <b>Boys</b> .....	137
<b>Otomo</b> Shogunate .....	21
Other Places in and Around <b>Japan</b> .....	17
Powers of the Millennium <b>Tree</b> .....	32
Traditional Japanese S D C <b>Weapons</b> .....	118
The Average Millennium <b>Tree</b> .....	29
The New <b>Empire</b> .....	11
The Republic of <b>Japan</b> .....	70
O.C.C. 's & R.C.C. 's	
<b>Bishamon</b> Fighting Monk O.C.C. ....	55
<b>Cyberoid</b> O.C.C. ....	78
<b>Cyber-Samurai</b> O.C.C. ....	80
Demon Queller O.C.C. ....	64
Female <b>Samurai</b> .....	49
Female Sohei — <b>Warrior</b> Nuns .....	60
Glitter Force Trooper O.C.C. ....	93
Infantrymen O.C.C. ....	92
Mystic <b>Ninja</b> O.C.C. ....	51
Ninja 'Borg O.C.C. ....	88
Ninja <b>Crazy</b> O.C.C. ....	86
<b>Ninja-Jucier</b> O.C.C. ....	84
Ninja <b>Techno-Wizard</b> O.C.C. ....	89
Police Officer O.C.C. ....	94
<b>Oni</b> R.C.C. ....	199
Other O.C.C. 's .....	95
Republic <b>Cyborg</b> Soldier O.C.C. ....	97
Robot <b>Pilot</b> O.C.C. ....	92
Ronin O.C.C. ....	49
<b>Samas</b> Samurai Pilot O.C.C. ....	91
Sohei <b>Warrior</b> Monk O.C.C. ....	58
Sura-Kappa R.C.C. ....	205
Tech- <b>Ninja</b> O.C.C. ....	82
Tengu <b>R.C.C.</b> .....	66
Traditional <b>Samurai</b> Warrior O.C.C. ....	43
Yamabushi <b>Mountain</b> Priest O.C.C. ....	60
<b>Monsters of Japan</b> .....	<b>199</b>
Goblin .....	206
Goblin <b>Spider</b> .....	207
Oni "One Hundred <b>Demons</b> " .....	199
Tables for Oni <b>Creation</b> .....	200
Oni <b>R.C.C.</b> .....	202
Oni <b>Master</b> .....	203
Oni <b>Mystic</b> .....	204
Sura-Kappa <b>R.C.C.</b> .....	205
<b>Mystic Martial Arts Powers</b> .....	<b>195</b>
Arts of <b>Invisibility</b> .....	195
Body <b>Hardening</b> Exercises .....	196
Zenjoriki <b>Powers</b> .....	197



# Endless Possibilities

What do you imagine when you think about Japan?

Is it crowded, ultra-modern cities filled with neon lights, computers, electronics, high-technology and thronging multitudes? Is it the **Yakuza**, tattoos, seedy geisha houses, dark allies, motorcycles and street gangs? Or is it the traditional samurai, ninja, warrior monk, shinto priests and martial arts? Perhaps it's the magnificent mountains, blossoming trees, tranquil Zen gardens, temples, Buddhist shrines and ornate castles? What about dragons, ghosts, two-toed demons and countless gods?

I tend to picture all these things when I think about Japan. Japan is an incredibly exotic place with a rich history that spans thousands of years and is filled with heroic and powerful characters like the samurai, monks and ninja. Its mythology is expansive and provocative, with literally thousands of interesting "**kami**," gods and spirits. In fact, it is said that Japan is home to 8 million kami and hundreds of "**oni**," demons, as well as goblins, ghosts and other supernatural beings. This all leads to a history of diverse religious, spiritual and mystical beliefs, powers and occupations that are especially unique and intriguing to the western mind. Even the landscape is provocative, with lush forests, cherry blossoms, beautiful waterfalls, jagged rock formations and (lots of) mountains. With **Rifts**®, any and all of these elements were mine to play with and I wanted them *all!*

As is so frequently a problem with an overactive imagination, my dilemma became which characters, powers, oni, kami, devices and ideas do I put into this book to make it balanced, exciting and capture all the elements necessary to make it all fit just right. Pat, a self-confessed techno-junky proposed a **Triax**™ style book brimming with robots, power armor, tanks and bionics. He would contribute significantly to these aspects of the book, but we also needed to capture the exotic atmosphere of the Japanese history, people, traditions and mythology. Pat came up with the idea of having two major human kingdoms, one super high-tech and the other traditionalist who worship ancient kami and completely reject technology. I loved it! This meant I could throw in everything and the kitchen **borg!** I came up with the idea of four actual pre-Rifts cities having been Rifted into limbo for the last 300 years, thinking only three days had passed, and popping back into **Rifts Japan** circa 87 PA! Pat worked on a bunch of the tech-stuff and contributed more ideas, while I developed the New Empire, Republic of Japan, other kingdoms, and cultures, along with the martial arts, mystic, magic and mythological stuff. Vince's art and suggestions by Julius, C.J., **Erick** Wujcik and other folks at Palladium only added to the depth and excitement.

The end result is one hell of a **Rifts**® **World Book!** As long-time **Rifts**® fans may already suspect, we couldn't fit everything we wanted for **Rifts Japan** into one book. Consequently, we are already working on a supplement that will focus on many of the key gods, oni, and supernatural beings that fill Japanese mythology. This book will also focus on magic powers, Shinto priests and a variety of other character classes. It is likely to be a big book (160 to 220 pages) and may be presented as a **Rifts**® **Conversion Book** with a title like *Gods & Oni of Rifts Japan*. It will be available in early 1996. And speaking of upcoming products, the following books are also slated for 1996: *The Juicer Uprisings*™, *Lemuria & Easter Island*, *Northern Gun*™, *The New West*™, and *Lone Star*. These titles are already in development! Other likely releases are *Rifts Chi-Town*™ or *The Coalition States*™, *The Omegan Order*™ and *Cyber-Knights*™, plus cool stuff for the *Palladium Fantasy RPG*, *Heroes Unlimited*™, *Robotech*® and *Nightspawn*™. Also don't miss the **Rifts**® **Game Master Companion**™, a super-whammy computer character generator that lets you create any character in less than five minutes, plus a *campaign manager* with an in-depth index of ten **Rifts**® books (on disk and in book format), a pair of game screens and tons of reference files and data. Seriously, if you have a Windows-driven computer, check it out! You ain't seen nothing like it!

Kevin Siembieda



---

---

# The Japanese Islands

By Kevin Siembieda with concepts and ideas by Patrick Nowak

---

---

One must remember that most of the planet is a hostile wilderness with only pockets of human or even non-human civilizations. Some of these pockets are nice, peaceful happy places, but others are frightening and terrible. Since we focus on adventure, we also tend to focus on the most dangerous places where conflict is brewing. Japan, paradoxically, is both peaceful, and safe, and at the same time, a hotbed of conflict and turmoil.

The islands of Japan are *extremely isolated* from the rest of the world, particularly from distant Europe and the **Americas**. Remember, long distance travel, especially by air or sea, is incredibly dangerous. Ground travel has its advantages and disadvantages, but is painfully slow and fraught with danger. Except for a handful of technological or magical nations, most methods of travel are roughly equal to that of the middle ages, with a great deal more monsters, bandits and dangers lurking between point A and point B.

Most of Russia, Mongolia, China India, and Asia are vast wildernesses dominated by monsters. The level of technology is archaic, in some cases only a notch above stone age. Most population centers are the domain of D-bees, oni or other supernatural creatures hostile toward humans. The few independent human civilizations that have managed to survive are suspicious of strangers and technology (which some may regard as magic), or are aggressive warriors, conquerors or freebooters who prey upon their fellow humans. Such is the situation for Japan. The handful of free humans around them, mainly Chinese and Koreans, are ancient rivals, new rivals, mercenaries, bandits and pirates who plunder the Japanese islands (and others) for their resources, slaves, and booty.

For travelers from more distant lands to reach Japan, they must travel through the wilds of Europe and then monster ridden Russia or the Middle East (old Iran, Afghanistan and Pakistan) and then through China. Harsh wilderness, deserts, and mountains bar every step of the way. The only alternative is the equally dangerous trek through Burma, Thailand, and Vietnam and then along the coast of China or through Indonesia.

No matter how one comes, the traveler must, at some point brave the sea, whether it be the China sea, Sea of Japan, Sea of Okhotsk or the Pacific Ocean! In the days before the Great Cataclysm and the transformation of Earth into a dimensional nexus, water or air travel were the easy alternatives to crossing thousands of miles of land and hostile natives. However, in the Time of the Rifts, such travel on the open seas or vast blue skies is suicide. Storms, mystic energy, ley line disturbances, or strange dimensional anomalies, can destroy a vessel or send it to another place or time before the traveler knows what hit him. Furthermore, countless sea serpents, flying predators, monsters, dimensional raiders, D-bees, aliens, demons, gods and supernatural beings lay in wait for victims foolish enough to sail in the open, away from the shelter and hiding places on land, and strength of numbers. Less than 30% of most airborne or ocean travelers ever reach their destination and many of them don't arrive in one piece. **Pirates** and seafaring people around the world are found primarily in isolated and shallow seas and inland lakes, but even they tend to stay near the coast or hop from one island to the next. Sailing the oceans is virtually non-existent in most places in the world. It is the relative safety offered by the multitude of islands around Japan, China and Indonesia that makes pirating, freebooting and sailing common to these areas. Only the *Horune pirates* and the *Splugorth*, both with their magic ships and inhuman powers,

sail the deep oceans of the world with comparative impunity. Yet even these masters of the open seas tend to stay in familiar waters and congregate in the greatest numbers around island clusters.

**Under the Sea** is an entirely different world. Here too are masters of the seas and mysterious creatures and civilizations. The elegant and powerful **pneuma-biforms**, dolphin, whale singers, **Lemurians**, sea titans, **amphib** mutants, and D-bees add to its wonders. There are budding aquatic kingdoms like **Tritonia**, and the war-like, yet benevolent, forces of Nemo-2 and his New Navy. Even the NGR has begun to explore the ocean depths in new wonders created by **Triax** Industries. Of course, there are evil monstrosities as well, the Lord of the Deep and its devouring minions, the invading and enslaving alien Naut'Yll, Horune pirates, Gene-Splicers, shadow sharks, storm riders, horrific mutants, dead **pools**, shimmering water and dimensional triangles. **Note:** All of these places, beings, and more are detailed in the pages of *Rifts Underseas*.

When the ley lines seethed with energy and the Rifts came, Japan was irrevocably changed in other ways. Honshu was split in half and southern Hokkaido was splintered. Tokyo and much of the coastline was devoured by the rising ocean. New islands appeared, old islands disappeared, and the courses of rivers and mountain ranges were altered. The entire world was reformed and transformed, into something different, something alien.

Old holy places and locations like the Dragon's Triangle (Japan's version of the Bermuda Triangle) rippled with mystic energy, creating dimensional anomalies, terrible storms, and opened portals to other worlds. Rifts in space and time led to alien dimensions and the domains of the gods and supernatural monstrosities. Creatures from ancient Japanese myth and legend, like the dragon, tengu and oni, once again walked the Earth and made Japan their home!

These lines of energy, the Dragon's Triangle, the storms they caused and the creatures they unleashed, have served to isolate Japan from the rest of the world, all the more. Thus, the western world knows little, if anything, about Japan. Most tend to associate it with demon infested China — a distant and foreboding land, best avoided and often forgotten. As a result, even **15** years after the **pre-Rifts** cities of *Hiroshima*, *Kure*, *Iwakuni*, and *Ichto* reappeared in all their technological splendor, the world is none the wiser.

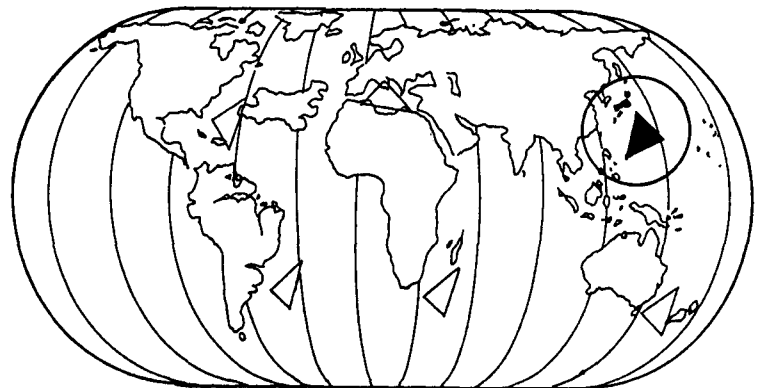



---

# The New Empire

---

By Kevin Siembieda  
with additional ideas by Patrick Nowak.

Population Breakdown of the Region: **6,800,000** total; approximately 1.2 million live in the city of Kyoto, with another half million in villages and communities outside the Holy City. The remaining 5.1 million live at other, smaller cities, towns and hundreds of villages scattered throughout the territory claimed by the New Empire. The average population of a city is **1D6×100,000**, a town: **1D6×1000**, and a village **2D6×100**.

60% Japanese Humans

5% **Non-Japanese** Humans

20% **Eta/D-bees**

15% Oni & Others — approximately 1 million, but this estimate may be incorrect and there could be twice as many. Most of these creatures live in the more remote and mountainous areas.

Population Breakdown of the typical Human Community:

73% Japanese Humans

8% **Non-Japanese** Humans

18% **D-bees/Eta**

1% Oni & Others

General Occupation Breakdown of Population:

2% Practitioners of magic

12% Spiritualists and Priests

22% Warriors

50% Farmers, laborers and craftsmen; ordinary folk.

14% Eta, lowly craftsmen, butchers and laborers.

General Religious/Philosophical Orientation

92% Shinto

4% Buddhist

4% Other

88% Unshakable Anti-Technologists!

7% Want a higher degree of technology, but are tempered with a high regard for nature, the environment, and spiritualism, but most abide by the shinto teachings.

5% Like and use high technology; mostly non-humans, eta, and mercenaries.

## History & Background

When the ley lines erupted and brought cataclysm to the world, the Japanese islands, Taiwan and most islands of the Pacific were devastated. The old mountains trembled and expanded; some rose higher, some changed their course, others **erupted** from the earth or sea with volcanic fury, others sunk beneath the waves. The very earth ruptured and heaved as if in the throes of primordial convulsions. Earthquakes and hurricanes toppled cities like fragile toys and uprooted forests. Devouring waves the size of mountains pounded the islands as if trying to cleanse them of man. Remnants of the cities left from the winds and quakes were washed away by the raging waves. No place on Earth was pounded as hard or ravaged so completely as Japan. In the wake of the Great Cataclysm, all that remained of Japan was a desolate wasteland. Huge portions of the coast were claimed by the ocean, including Tokyo. Millions perished in a matter of hours.

It is said that less than **1%** of the entire population of Japan survived the Great Cataclysm. Those who miraculously lived through the carnage saw their nation, one of the technological meccas of the modern age, obliterated. Japan's cities, culture and technology had been literally washed away. Except for a few locations in the mountains, the islands of Japan were little more than barren rocks. No cities, no villages, no farms, no shelter, no boats, nor communication with the outside world, only a few thousand people and a few battered mountain forests was all that remained.

A mixed **blessing** of sorts, was that the islands were so wiped clean that there were few corpses left to fester and breed pestilence — a plight that plagued many landlocked nations and which would claim hundreds of millions of lives in mainland China and India. Unfortunately, this also left precious few technological weapons, tools or materials to salvage. Worse, the entire world seemed to suffer the same fate.

In the dark ages that followed, the survivors clawed at the dirt and struggled to see the dawn of each new day. In addition to everything else, the world was irreparably transformed. Lines of pale blue energy crisscrossed the land and radiated from holy places. Within a few months, strange animals of the air, land and sea began to appear — often alien creatures not from this world. A short time later, *oni* ("demons"), dragons and creatures of myth and legend came down from the mountains. Indeed, it was a world gone mad. Yet miraculously, the people survived and slowly began to rebuild in this strange, transformed Japan.

With the passage of time, other survivors of Japanese heritage who had been living or vacationing abroad (and their descendants), returned to help rebuild their homeland. For example, many of those located in Germany and Poland survived, but 75% of all of those who attempted such a pilgrimage perished in the arduous trek across devastated and savage lands.

The New Empire is largely an agrarian society organized around the village. Cities exist but are few and far between. Villages are scattered everywhere throughout the New Empire, especially along the coast, valleys and plains suitable as farmland. The average village consists of numerous houses, each constructed from wooden frames and shoji paper. Homes of important individuals have walls around the perimeter and include carefully tended gardens. Samurai are quartered within the best houses available, followed by the village headman, merchants and peasants in descending order of rank. Within the village is an enclosed area set apart for the eta, a mini-village of sorts.

Each **village** has a number of samurai present according to its size and strategic value. These warriors provide the populace with protection but also serve as overseers, ensuring that order is maintained and crops are properly tended to. Merchants are also present, operating small businesses in the larger villages and towns. The remainder of the population is composed of peasant farmers, craftsmen and eta. Life revolves around basic duties and tasks to be performed. As a result, the farmers tend to their fields, the craftsmen to their crafts, while the eta are left to pursue the most distasteful tasks of the society. Villages are largely self-sufficient and operate in a smooth, orderly fashion.

**Cities** are **basically** large-scale communities with a hundred thousand or more people. Almost every city in the New Empire has risen around a castle or similar fortification which provides the stronghold for a daimyo. Accordingly, most provinces will have only one city, the capital and center from which the samurai-barons rule. Since each daimyo commands a large force of samurai, a good portion of the city's houses are devoted to quartering the warriors and their families. Mer-



chants are also found in a high concentration at the urban centers. Peasant farmers are less plentiful than in villages but laborers and craftsmen are numerous.

## Kyoto

**Kyoto, the Holy City**, is the center of the New Empire. The city was completely demolished during the Great Cataclysm, but has been rebuilt as the new cultural center of the Japanese traditionalists and capital city of the New Empire.

In the heart of the city is a 1000 foot tall Millennium Tree. The Sacred Tree possesses magical powers and has served as an anchor for human civilization, especially in the early days. Its magical protection and "gifts" were what helped the survivors of the Great Cataclysm fend off the oni and other supernatural horrors that plague the island. It was around the mystical tree that a great city grew and the dream of the New Empire arose. Other cities and shogunates developed in the region, crisscrossing the greatest concentration of ley lines in all of Japan, but none prospered or grew as quickly as Kyoto. Thousands flocked to the incredible tree, causing scores of villages to appear like sprouts. Several old and new religious orders who worship or revere the Millennium Tree began to develop and add spiritual and fighting strength to the community (Today, Kyoto is filled with temples, shrines and monasteries. It is also visited by holy men and pilgrims from throughout the Japanese islands and occasionally, even China and Korea).

With time, these and many of the surrounding villages, cities and kingdoms would become united as the New Empire.

In the background is the beautiful **Mount Fuji**. The volcanic mountain is the largest in Japan and said to be inhabited by powerful kami (gods and spirits); the greatest of which is the female spirit of the mountain itself. According to legend, Mount Fuji rose out of a quiet valley in 286 B.C. during a tremendous earthquake. The long dormant volcano sprung to life again during the Great Cataclysm and grew another 600 feet (183 m) taller than its pre-Rifts height. The mount has been dormant again for the last 200 years. Mount Fuji was not the only mountain to explode to volcanic life. New volcanos erupted on and around the main island to change the shape and face of Japan; new mountains and islands appeared in the island chain, others crumbled away or sunk beneath the waves.

Mount Fuji is home to the winged mountain goblins known as the *tengu*, **yamabushi**, Shinto and Buddhist priests and monks, hermits, scattered tribes of goblins and oni, and is dotted with tiny villages. The occasional dragon, **ki-lin**, gryphon and unicorn are also said to inhabit the mountain forests. At its highest peaks, elementals, and some say ancient Shinto Gods, also reside. Compared to the valley regions and Kyoto, Mount Fuji and the other mountains located in the New Empire are lightly populated wildernesses.

## Traditionalism of the New Empire

The survivors of the Great Cataclysm have rebuilt society and technology from scratch. This meant **relearning** how to make primitive tools and weapons, and living off the land. In several instances, ancient gods and good spirits sent heroes, magic weapons and even made a few personal appearances to save them from demons and other horrors. This combined with the vast amount of magic energy (P.P.E.) and a return to spiritualism, convinced many that they had erred in their old lives; that they had lost touch with nature and the spirits of Japan, and that this was their chance to rebuild a new and better Japan.

The Shinto religion with its beliefs in kami and nature flourished like never before. Within 30 years, a large portion of the entire population were avid shinto followers. Shinto priests taught that technology was bad and that the *Bachi* (meaning the "Divine Punishment," as they

call the Great Cataclysm) was caused by angry gods who destroyed the devouring **techno-world** so that humankind could reflect on its tragic past and rebuild. This means that the survivors of the Bachi are "chosen people" obligated to build a better Japan. According to the priests, this means a complete abandonment of high technology and a return to pre-industrial age ethics, beliefs, government and technology, with an emphasis on the spiritual and the magical. This belief is the entire *foundation* of the New Empire and has become a steadfast way of life.

Every aspect of the New Empire's culture is based on the old ways. Thus, the Shinto belief is the dominant religion. This has fostered a return to the belief in magic and spirits, the mastery of the martial arts (along with mystic powers), and all manner of improvement and mastery of self and spirit through meditative reflection and willpower.

Anti-technology is the fervent belief of the vast majority of people in the New Empire, even among those who are not strict believers of Shinto. All machine technology above the equivalent of 16th Century Japan is rejected — the priests ultimately deciding what is acceptable and what is not; even black powder guns and steam power are seen as bad and a plunge into decadence and inevitable destruction.

The Way of the Warrior (Bushido/samurai) has been reinstated, so the kingdom is divided into smaller provinces controlled by daimyo and united under one military government.

The society was rebuilt on the traditions of the past, but stability would elude the New Empire for nearly a century. Development of the fledgling country was stunted by periodic civil wars amongst the samurai lords, but mainly from invasions by the "oni," demons from Japanese mythology. Most often, small to medium-sized bands of demons would raid villages and fledgling cities. Sometimes they would simply loot and vandalize, other times they would rape and murder, often burning villages to the ground. The worst were the armies of oni, five thousand or more demons swarming from the mountains like devouring locusts, destroying everything and everybody who stood in their way. Constant monstrous reinforcements arrived through dimensional Rifts to bolster the monster hordes. Along with the demons, appeared dragons, elementals and other strange beings. Ironically, it was the constant threat of invasion by monsters that would encourage many of the fledgling kingdoms, shogunates and villages to unite as one greater kingdom. Joined by a common cause and a common enemy, the New Empire exploded into power around 1 P.A.!

To facilitate this reformation, the daimyo from across the New Empire gathered at New Kyoto. At the demand of the Emperor, they remained in the capital city until a governing system upon which they all agreed was developed. Though it would take more than a year, they devised a satisfactory system to all of them. Rather than having a single supreme dictator, they decided to form a council on which all eight of the daimyo would serve. Each of these council members would have an equal share of power with which they would govern. The Emperor would have the deciding vote and could veto any action he (or she) felt was not in the best interest of the nation. Each daimyo would also be given a relatively free hand in governing his province or shogunate, but was expected to cooperate completely with the other seven in all matters! There would be no bickering over trade, boundaries or power. Each would also maintain their own armies, but would contribute 20% of his samurai to the national army (which has an equal number of warriors gathered from all of Japan). These troops are under the direct command of the shogun; however, in times of war when the entire Empire is threatened, the daimyo would accept the shogun as their Commander and obey his orders completely and with urgency. This effectively makes the shogun the top ranking General of the New Empire's Army, with each daimyo a subordinate, but top ranking General in command of their own army division, under the shogun's direction.

**Note:** The council members meet at Kyoto at least twice a year; more often as situations dictate. This system of government has been in place for decades.

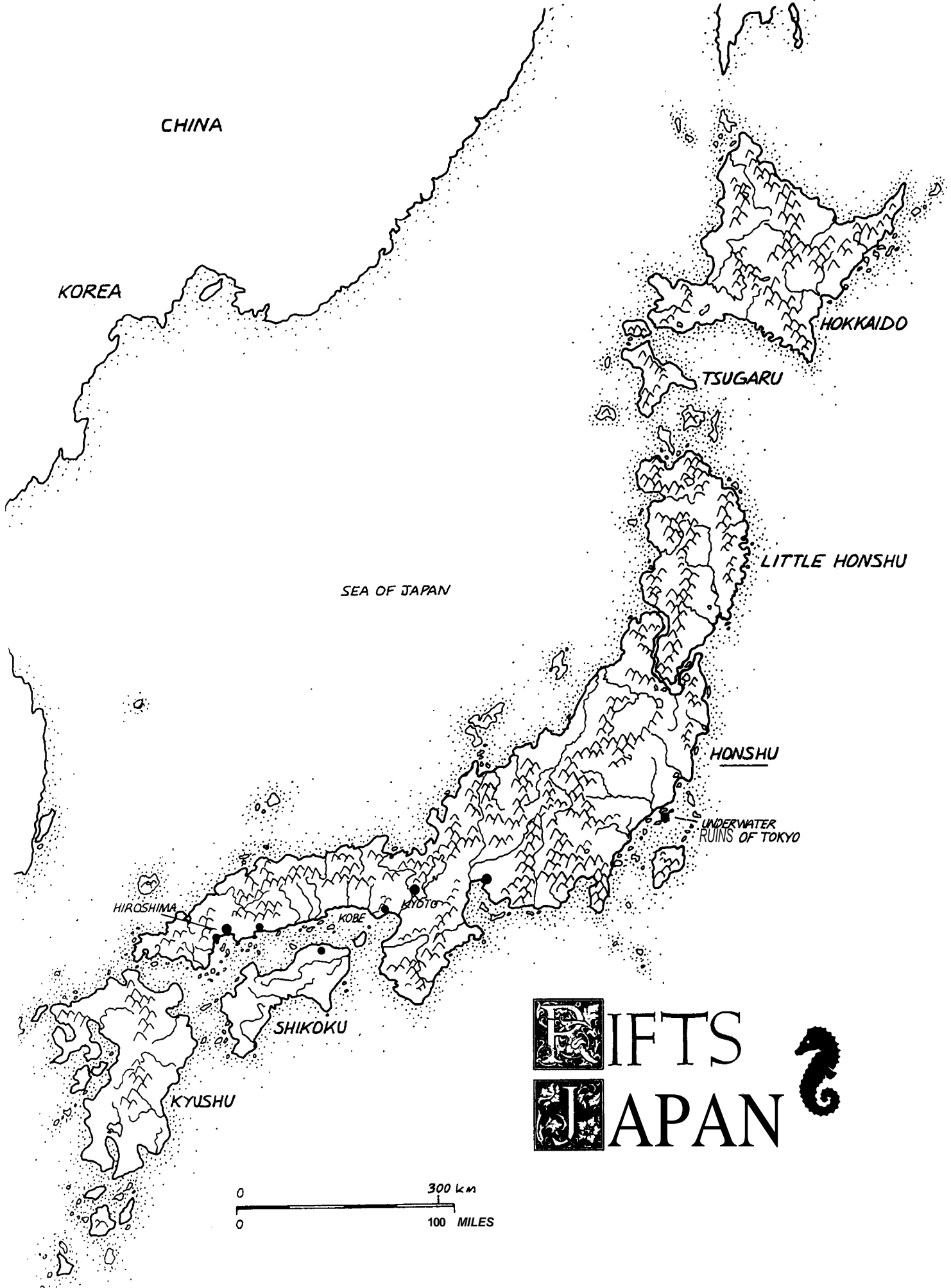

CHINA

KOREA

SEA OF JAPAN

HOKKAIDO

TSUGARU

LITTLE HONSHU

HONSHU

UNDERWATER  
RUINS OF TOKYO

HIROSHIMA

KOBE

KYOTO

SHIKOKU

KYUSHU



IFTS



JAPAN



# A Caste Society

The New Empire operates as a benevolent military dictatorship *similar* to the ways of old feudal Japan. It is a pyramid power structure with the wealthy and educated landowners and military at the top and the average citizen at the bottom.

Society in the New Empire is structured around the tenants of the feudal system. This dictates the rights of individuals and their status through the institution of several social classes. Equality between the classes does not exist, but the members of all groups have accepted their roles in the firmly entrenched **socioeconomic** system. Duty and responsibility is the cement which binds the classes together. Individuals are less self-serving and more community oriented, accepting their role and fulfilling it to the best of their ability. Revolution is virtually unheard of in the New Empire due to this highly developed sense of duty.

**The Emperor** is the religious and political leader of the Empire. This is no figurehead. The royal family from which the Emperor (usually male, but can be female) is born is said to have been selected by the sun goddess and possesses some aspect of true divinity. Indeed, the line of Emperors that have thus far arisen have been wise, merciful and strong leaders. They are fervent Shinto followers and ardent anti-technologists — raised and taught by the greatest Shinto priests in the land.

According to legend, the Sun Goddess, *Amaterasu*, appeared to the humans at Kyoto after a victorious fight against oni hordes. Clinging to her gown was an eight year old boy. The child, *Toyo Tenu*, an indirect descendant of the Imperial line, was named Emperor by the goddess. She charged those present to protect the boy and to "forge a New Empire" from the ashes of the old. It was on that day that the dream of a "New Empire" was born.

**The Imperial Court & Royal Family** have the ear of the Emperor, but are mainly positions of prestige with no or little actual power. This group includes family members and counselors such as respected priests, monks, aging samurai warriors, powerful landowners, philosophers, doctors, and other people of experience, learning and wisdom.

**The Shogun** is the Minister of War and the primary military power of the New Empire. In the past, the shogun was the real power in Japan, but in the Empire, he accepts the Emperor as his master and is satisfied with his position as Second in Command. It is the Shogun who coordinates the nation's defenses and directs any offensives with the national army into The Zone. Military expeditions into The Zone (and the **Freelands**) usually have to do with border skirmishes, reclaiming territory seized by the oni, or the rescue of captives taken by the demons.

**The Daimyo** (pronounced **dime-yo**) are the lords or governors of the Province. The New Empire is divided into eight provinces, each with a capital city and an army of samurai loyal to the daimyo and the Emperor. The daimyo are also wealthy, samurai land barons who serve as military generals. They accept the Emperor as *the* heart and soul of Japan and defer to his wishes, which are usually fair and rarely interfere with their local policies and conduct. The daimyo and the shogun are second in power only to the Emperor.

**The samurai** are elite warriors, landowners and administrators, loyal to a specific daimyo master and province, and the New Empire in general. Most are noble, honorable, and heroic knights of the realm dedicated to keeping the New Empire safe. Each samurai is granted a portion of farmland and indentured peasants by his daimyo, in order to support himself. These holdings are fixed by family lines, such that a samurai's children inherits the noble class, land and obligation to the daimyo. The daimyo has complete control over his vassals, so much that if a samurai should fail in his duties, even **once**, he must make restitution or his daimyo has the right to demand "honor be met," meaning the samurai is obligated to commit ritual suicide. Loyalty and obedience to one's lord is extremely important in this military society.

At the base of this pyramid structured caste system are the multitude of **peasants** (uneducated laborers and farmers) and the lowly **eta**. It is interesting to note that in the structure of the New Empire, there is nothing

dishonorable about being a peasant and indeed, the peasant farmers, workers and craftsmen represent the **life's** blood of the kingdom. They work the land, farm, harvest and process crops, raise animals, weave and fashion clothing, and serve as carpenters, builders, kabuki entertainers, and craftsmen of all kind. They work the lands owned by the samurai and their daimyo, and live in homes owned by their landlords. They cannot own their own land, cannot bear arms (other than farm tools and staves), and are uneducated; they may have certain *trade skills*, but no formal education. It is the members of the samurai family clans who become the doctors, scientists, scholars, architects, engineers, artists, owners of business, and politicians of the realm. The only way for a peasant to get a better education and pursue a different type of work is to become a monk, priest, or kabuki entertainer; or to leave the New Empire to become a mercenary or adventurer.

Most peasants are happy and treated reasonably well, although their living conditions, welfare and the respect they receive is largely dependent upon the landowner(s) they serve. Some daimyo and samurai landowners work the people like animals, with little rewards for their labor or loyalty. Others treat them with great kindness and generosity. Fortunately for the peasant population, most daimyo and samurai take their cue for behavior from the Emperor, nobility and priests at Kyoto, who show respect, honor and mercy to even the lowliest peasant. Currently throughout the New Empire, most administrators and lords treat their people well, and the samurai truly fight to keep them safe and free from inhuman tyranny. This is due, in part, to the strong leadership of the Emperor and the genuine presence of the gods, spirits and the Tree of Life.

**The eta** are a different story. They are the lowest of the low and fall below peasant or even the detestable ronin. They are people who do labor that even the peasants find disgusting or beneath them. All the distasteful tasks in the New Empire are left to eta. These include the handling of the dead, digging graves, waste disposal, butchering and preparing animal meat as food, tanning, leather-working and making clothing out of animal skins, and similar.

Most "eta" of the New Empire are D-bees (65%) or foreigners (20%), however some (15%) are humans of Japanese descent — but all are considered to be less than human. They are treated badly/rudely, forced to live in run-down slums, and subjected to physical and mental abuse at the hands of samurai and peasant alike. For example, a samurai can seize an eta's property, ransack their home, use torture for interrogation, rape their women, beat and even kill eta without evidence of wrongdoing and without fear of legal or social repercussions — of course the eta may extract their own revenge by stealing from their cruel masters, vandalizing property, cooperating with enemies and even engage in murder. It is among the eta that one is most likely to find thieves, bandits, assassins, ninja, witches, evil sorcerers, and other criminals. Sadly, many people point to this foul behavior as evidence of the eta's sub-human and vile nature, without realizing that it is the cold-hearted abuses and degradation delivered from their hands to the eta that fill them with hate and vile, and make them desperate misanthropes.

**Merchants** are part of the peasant class, as the act of making and selling goods and handling money is not considered a noble pursuit worthy of a warrior. However, a samurai may *own* a business, he's just not active in it. Subordinate to the samurai, these merchants still have a fair degree of unofficial freedom and privilege. Merchants can, within the framework of the law, own property (but not land), travel freely throughout the Empire and engage in enterprises and the pursuit of trade and profit. Additionally, the merchant is able to deal with members of the samurai class on a fairly equal level. Politeness and respect are obvious requirements, but the merchant has the right to bargain and safeguard their own best interests. 65% of all merchants operate a business owned by a samurai family clan, but a full 35% are privately owned companies.

**Ninja** are peasant elite mercenaries who operate from secret family clans. Masters of disguise, they sometimes pretend to be monks, priests, and samurai.

**Doctors** are one of the few groups outside the caste system. Although the majority (60%) are of noble lineage, many are from peasant stock. However, healers are both respected and appreciated, and free to walk among eta and samurai without regard to class or character.

**Monks and priests** enjoy a similar status, although they are generally considered to be of peasant stock and only a notch above them. Despite this, priests and monks are often counsels to royal families, daimyo, and samurai, as well as warriors of renown.

There is no class requirement for becoming a monk and anyone from the lowly eta to the powerful samurai can join the monastic orders. Serving as the spiritual caretakers of the people, the monks tend to the many shrines and temples in the Empire. Others wander the countryside teaching and lending a helping hand. Monks are held in the highest regard and are protected by the samurai. These individuals are subject to the same punishments for criminal activity, though all but the most severe crimes are usually ignored. Should a monk ever be attacked or harmed, retribution will be both swift and severe.

**Wizards and sorcerers** are frequently considered unallied spirits without class or distinction. They may fight in a battle to defend the Empire, counsel a daimyo, or become part of the Emperor's court, but they have no position within the caste society. Sorcerers, who often keep to themselves, are inquisitive by nature and embark on adventures and explore other lands. The shinto priests say that the "entire world is the home of the sorcerer. To limit his domain to any one province or kingdom, no matter how large, is like putting a bird in a cage."

**Cyborgs** in search of the spirit and nature are welcomed in the New Empire, especially among monastic orders. These are **'borgs** who feel they have lost touch with their human nature and seek to regain it through meditation and learning to be one with nature. In many instances, they cannot afford to be converted into an artificial bio-system body and reject the idea of being placed in a clone body, so they are trapped in a mechanical one. Many also endure mental scars from years of combat, which may have also severed their link to humanity and/or has crushed their sense of compassion. Approximately 48 of these **'borgs** reside in the New Empire; some have become warrior monks, but others try to function in normal society.

**The newly converted.** Over the years, a trickle of people from the Republic of Japan and other technologically advanced kingdoms have forsaken modern life and sought to build a new, simpler life in the New Empire. All who are sincere anti-technologists are welcomed and integrated into society. Most (70%) become peasant farmers, laborers or craftsmen, some (15%) become priests and monks, a handful (4%) samurai, while others (6%) become eta or mercenaries. A surprisingly small number (5%) give up their simple life to return to modern life,

**Slavery does not exist** in the New Empire, although the social position of the eta may seem like it sometimes. Slavery is regarded as repugnant and inhumane.

### The Average Peasant or Eta

There is no established schooling system but each family, even the lowly eta, sees to the education of their children. Consequently, most peasant occupations are passed on from generation to generation. Most peasants are farmers, fishermen, carpenters, or craftsmen with basic occupational skills passed on from father to son, or totally unskilled laborers. All peasants have the following skills:

Language: Japanese at 96% proficiency and one of choice **(+10%)**

Domestic: Cook and dance **(+5%)**

W.P.: Blunt, chain, knife, slingshot, or staff only; choice of one.

Hand to hand: basic, martial arts/judo or aikido.

**Note:** Only 15% can read and write.

In addition, the character can select four other skills that **reflect** the person's **occupation/trade** and four secondary skills (no bonuses) from the following categories:

Domestic (any +10%), medical (holistic medicine and basic first aid only), physical (any), rogue (any except computer hacking; +6% for eta only), technical (any except computers and photography), W.P. (any for the eta, but most are illegal; peasant choices are listed above), and wilderness (any +5%). **Note:** The eta can select two additional skills from either espionage or rogue with a +10% bonus.

## Industry & Technology

The New Empire is a primarily agrarian-based nation. Fiercely against technological development, they rely on old world craftsmanship, skills and labor. At best, technology in the New Empire is of a primitive nature equal to the **pre-industrial** revolution period. This is not due to any educational or intellectual limitations of the people, rather it is because of Imperial decree. The people of the New Empire have no love for technology and prefer their simple existence. They feel close to nature and content.

## The Military & The Law

The samurai represent the omnipresent military and the law. They are joined in the defense of the nation by priests, warrior monks and the occasional practitioner of magic. Priests and monks also help to police villages and cities, settle squabbles, and counsel about philosophy, behavior and ethics. See the various traditional O.C.C.s for more details.

Crime is not a serious problem in the prosperous and enlightened New Empire. The real danger comes from a host of outside sources, the oni hordes, imps, goblins, wilderness bandits, pirates, witchcraft, sorcery, dragons, other monsters, would-be conquerors, rival kingdoms, high-tech ninja and bandits, high-tech mercenaries, and foreign invaders.

### Weapons Restrictions

Punishment for the possession of forbidden technology is severe, and lead to banishment and even a death sentence.

Strict legislation is in place for the restriction of weapons in the New Empire. Only the samurai are allowed to carry and use the sword, bow and other weapons.

Peasants are not allowed to own, use or carry swords of any kind, the bow and arrow, or any other weapon. The only exceptions are items that are normally farm tools, like the sickle, mallet, club, staff, knife, and similar items. Possession of a weapon will result in having the item taken away, the home searched for more (and those are confiscated too), and five lashes of the whip. Repeat offenders may be beaten and, if suspected of criminal activity or insurrection, imprisoned, or thrown out of society and made to become an eta.

Peasants are not allowed to learn horsemanship or ride horses. However, they may own horses, donkeys or oxen to pull carts and to plow fields. The punishment for riding a horse like a samurai is a sharp reprimand. Repeat offenders get six lashes from the whip and may have their horse taken by the samurai.

Acts of theft, assault and vandalism usually result in a lecture, a beating or whipping and restitution for any damage or loss.

Murder and attempted murder are likely to result in banishment or execution.

Possession of technology is likely to result in public humiliation, chastisement, and hours of lectures from a monk or priest.

Committing a crime with a high-tech weapon will result in banishment or execution.

Committing murder with a high-tech weapon means execution.

Using charms and magic to swindle and cheat people is also a serious offense.

**Note:** Execution is usually by beheading.



**THE NEW EMPIRE**

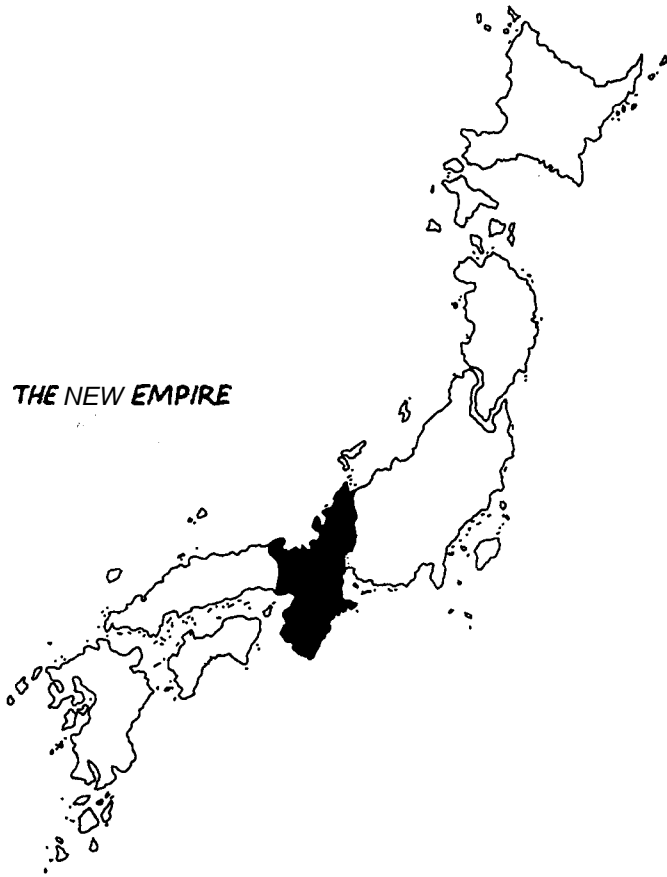

**Foreign Relations**

The New Empire is self-sufficient and strong. This means there are numerous forces who want what it has. Unlike the Republic of Japan, the New Empire has existed in one form or another for nearly 200 years, and a power to reckon with for nearly a hundred. Thus, it has many enemies.

One of the primary tenants of the *New Empire* is an anti-technology doctrine. This has earned the kingdom the animosity of such powers as the **Otomo Shogunate**, **H-Brand** and newcomer, **Ichto**.

**China:** The New Republic has no ties and little experience with any kingdoms in China. Several expeditions of samurai, monks and priests have gone to China, but all report the country is infested with oni. Korea and Taiwan are not much better. Consequently, they try to avoid these places so as to not provoke a conflict — they have enough problems with demons without looking for more trouble. They do however, raid pirate ships in the East China Sea and along the coast.

**The Republic of Japan:** The citizens of the Republic call the citizens of the New Empire, “**anti-techies.**” The anti-technology proponents at the New Empire have dedicated their lives to making the Republic see the folly of their ways, forsake technology, and join the New Empire. To this end, they have engaged in countless peaceful demonstrations, protests and philosophical discussions, both on a large scale (public speaking engagements) and on an individual basis. In the latter case, monks, priests and devotees, wander the streets of the Republic, talking to strangers about the Bachi, the return of the gods, **kami**, nature, serenity and so on. The people of both nations have great respect and understanding for each other, so such encounters are usually taken in good spirit, politely dismissing the street preachers as they hurry off to work or home. There has been some acts of violence by fringe groups and fanatics within both groups, but these are the exception rather than the rule. Despite the differences between the two nations, relations are good and if one fell under siege by hostile forces, especially oni or foreigners, the other is likely to rush to their aid.

Both the Republic and the New Empire allow visitors from each respective kingdom free and easy access to the other (although the New Empire allows little trade). As a result, strong ties of friendship have de-

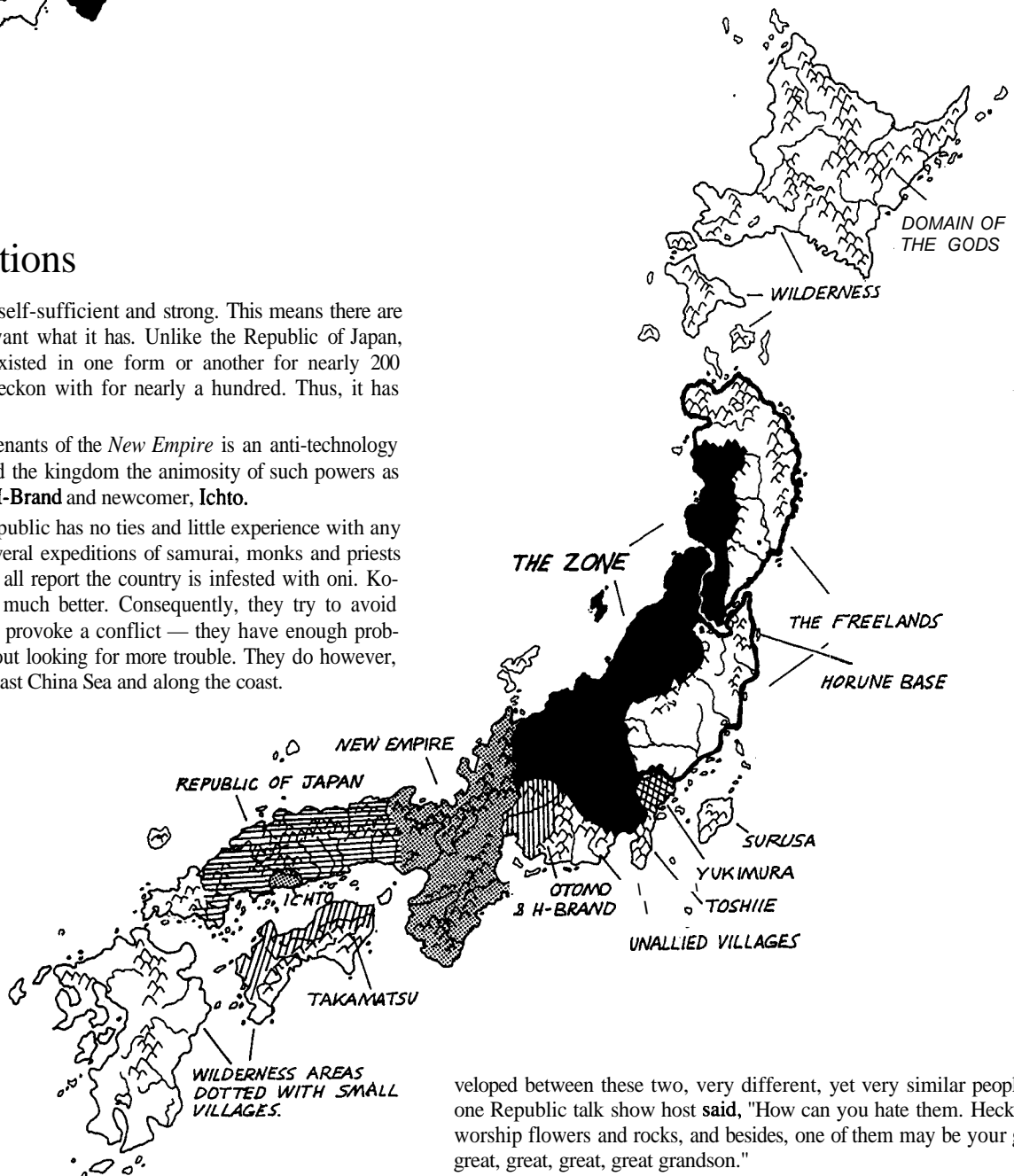

veloped between these two, very different, yet very similar people. As one Republic talk show host said, "How can you hate them. Heck, they worship flowers and rocks, and besides, one of them may be your great, great, great, great, great grandson."

**Ichto Province:** The relationship between Ichto and the New Empire is becoming explosive. To the anti-technologists, they represent the cruel, foolish arrogance that high-technology seems to breed. Meanwhile, the political powers at Ichto are insulted by the anti-teenies' talk of destruction, arrogance, indifference and crimes against nature, and have banned them from their tiny kingdom. Numerous fights, acts of sabotage and murder have been the result from clashes with these two. In fact, Ichto recently outlawed "anti-technology" sentiments, stating that such talk and philosophy is treasonous, and anybody who harbors such feelings should stay away. Hundreds of anti-techies have been banished from Ichto and hundreds of others languish in prisons, convicted of being political activists, spies, and terrorists.

**Takamatsu:** This kingdom and the New Empire share a similar relationship as the one with the Republic of Japan. The two have engaged in irregular trade and 50% of Takamatsu's citizens are shintoists, just not extremists. These people believe that technology and nature can co-exist in peaceful harmony. The two kingdoms also have mutual rivals and enemies in Ichto, Otomo, H-Brand and the monsters from The Zone.

**Otomo Shogunate & H-Brand:** Bitter enemies. Over the centuries, these two powers have clashed often. The New Empire considers them to be as honorless and decadent as the despicable oni. Otomo and H-Brand also cause trouble for the New Empire by their creation and harboring of ninja juicers, ninja crazies, and ninja borgs, as well as the indiscriminate sale of weapons of destruction and terrible augmentation to bandits, pirates, mercenaries and enemies of the New Empire (and all free, peace-loving people). Otomo and H-brand don't care. Their business is war, often selling weapons and products to both sides of a conflict, and instigating trouble to line their pockets.

**The Zone — Demon Hordes:** This is the New Empire's oldest and greatest enemy. The Empire is responsible for the destruction of hundreds of thousands of oni, just as the demons are responsible for the death, molestation and enslavement of tens of thousands of humans. Many samurai, priests, and monks (as well as adventurers) have devoted their lives to ridding Japan of the demon hordes.

**The Freelands:** The rugged wilderness of northern Honshu and Little Honshu are considered the lands of barbarians. They are avoided by most citizens of the New Empire, unless they are looking for adventure or work as a mercenary. These lands are unclaimed and home to wilderness people, adventurers, mercenaries, oni, D-bees, eta and other *undesirables*.

**Coalition States/The Americas:** No knowledge or contact.

**Triax and the NGR:** None. The New German Republic has heard a few dozen stories about a Japanese Empire, but the details are conflicting.

**Splugorth of Atlantis:** The Splugorth have little interest regarding this demon infested part of the world. They acknowledge the dominance of other powers in China, Japan and Asia and, at least for the moment, have turned their attentions to other matters in Atlantis, Europe, Africa, and the Americas.

**Tritonia:** The New Empire has heard stories about this distant sea nation of mutants and humans from pirates, sailors, dolphins and whales, but has never had direct contact with them. Only a tiny handful of adventurers and pirates have ever been to Tritonia.

Likewise, the people of Tritonia have heard a few stories about a kingdom of noble warriors surrounded by demons from dolphins, whales and the occasional freebooters, but have never had reason to make contact with them. See *Rifts Underseas* for details.

**Nemo-2 & the New Navy:** Nemo and his forces know a little bit about Japan and the New Empire; enough to know that they are anti-technology, so they have avoided contact with them and turn their attention to other matters. The New Republic knows nothing about them except for a few stories from friendly dolphin. See *Rifts Underseas* for details about the New Navy.

**Naut'Yll:** The rare, raiding party from the Naut'Yll Empire has attacked Japanese ships and occasionally raid the islands of Indonesia. These aquatic warriors have had a handful of clashes with Japanese samurai and martial artists, but don't know anything about the people, their beliefs or abilities. See *Rifts Underseas* for details about the Naut'Yll.

**Horune Pirates:** The monstrous dimensional raiders have plundered the island of Japan, Indonesia, Polynesia, and surrounding seas, oceans and coastlines for decades. They have fought each other many times. The Horune are notorious pirates and slavers who occasionally work with the oni and frequently trade with the barbarians of the Freeland, and the oni in the Zone. They are considered to be monstrous invaders as evil as any oni. **Note:** One Horune pirate clan has a secret base located on an island off the north eastern tip of Honshu. Another larger and more powerful clan occupies the island of Okinawa. The warriors of the New Empire have forced them off of three other locations in the last 20 years. See *Rifts Underseas* for details about the Horune.

**Other people and places:** The New Empire has explored much of the land around them. They have been to China, Korea, Taiwan, Burma, Indonesia, Guam and the Demon Triangle of Japan (actually a few hundred miles southeast of Japan). However, these expeditions have only given them a glimpse of their *everchanging* world and they are the first to acknowledge that there are many things they still don't know.

---

## Other Places in and Around Japan Takamatsu

---

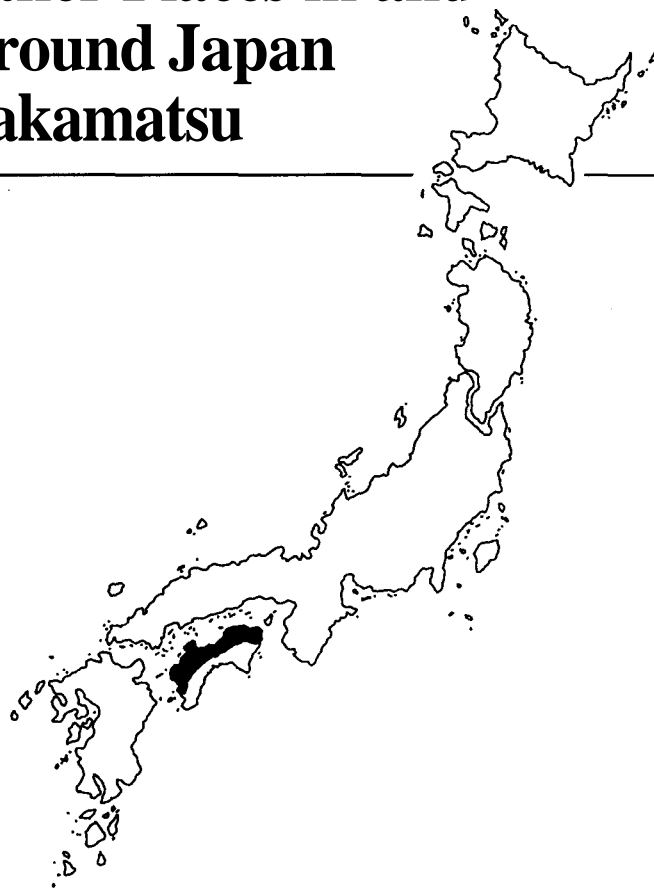

Population Breakdown: 320,000 total; approximately 148,000 live in

the city of New Takamatsu, the rest live in scattered villages, farms, and fishing villages along the southern half of Shikoku island.

62% Japanese Humans

8% Non-Japanese Humans

26% D-bees

4% Oni & Others

Note: Approximately 55% of the population have a formal education and are literate in Japanese. 12% can read and write English/American. The rest are skilled farmers, fishermen, craftsmen or laborers.

The Republic of Japan has been strengthening its ties with (and dependency on) the Takamatsu kingdom. **Takamatsu** is a reasonably modern society with industrial capabilities roughly equal to the early 20th Century. Its main asset is the ability to use a *dimensional Rift* to travel to a (seemingly) uninhabited Earth-like world and exploit its natural resources. Takamatsu has mining and processing operations on this world as well as on the Japanese island of Shikoku, which it dominates. Its trade with the Republic of Japan is making it a stronger, wealthier, independent kingdom. The kingdom trades petroleum, iron ore, and other minerals to the Republic in exchange for high-tech weapons, armor, vehicles, machinery, parts, electronics, medicine, and education. This enables the community to improve its level of technology, manufacturing, defenses and quality of life.

Takamatsu officials have recently suggested signing an official trade and defense alliance pact with their symbiotic benefactor; the Republic is giving the offer serious consideration.

Takamatsu grew out of the upheaval and carnage of the Great Cataclysm. The people on this island had some advantages others didn't. The fertile valleys of northern Shikoku provided the people with rich farmlands; the light forests provided wood for houses and boats; fishing is good around the island and mostly free of the monsters that seem to infest other waters around Japan. Furthermore, the oni don't often travel this far south and a small, underground part of the city of Takamatsu survived the holocaust, providing them with some link to their past and a small reserve of technology. With time, the islanders were able to hammer out a self-sufficient community at a moderate, post industrial level.

## Society

The society at Takamatsu is a strange conglomeration of people, cultures and technology. There are true samurai and **cyber-samurai**, shinto priests and high-tech troops, sohei monks and power armor (acquired from the Republic, Ichto or **H-Brand**), illiterate peasants and engineers, wizards and 'borgs, humans and non-humans. It is without a doubt, the biggest melting pot of cultures, faiths and people in Japan. This tolerant and diverse setting has its own dynamic energy and atmosphere that makes it an exciting place to visit. Many locals playfully call it the "Little Brother Republic Empire," because in many ways, it does seem to be a combination of the two.

Takamatsu has become much more prosperous since it began to trade with the Republic of Japan, but it is not an especially rich or powerful kingdom. Its main advantage at surviving has been its geographic removal from the main island, giving it some breathing space from the oni, as well as rival kingdoms like the powerful **Otomo** Shogunate and others.

# The Ichto Province

## Home of Ichto Robotics

Population Breakdown of the Region: Ichto is a comparatively tiny nation (the corporate rulers prefer "nation" rather than "kingdom") of approximately 420,000 people — 240,000 Japanese and 180,000 **nonhumans**. Ichto is the major, industrial city with 260,000 (mostly humans) surrounded by scores of low-tech and no-tech villages.

55% Japanese Humans

1% Non-Japanese Humans

43% D-bees

1% Others

The Ichto Robotics Corporation is an ancient rival of **ArmaTech** and has become an independent kingdom in and of itself. Shortly after Hiroshima and surrounding communities "popped" back to Earth from the pocket dimension, Ichto, ArmaTech and the quickly forming new government (and nation) clashed. Ichto, on the outskirts of the high-tech pocket, split from the fledgling Republic of Japan and declared itself an

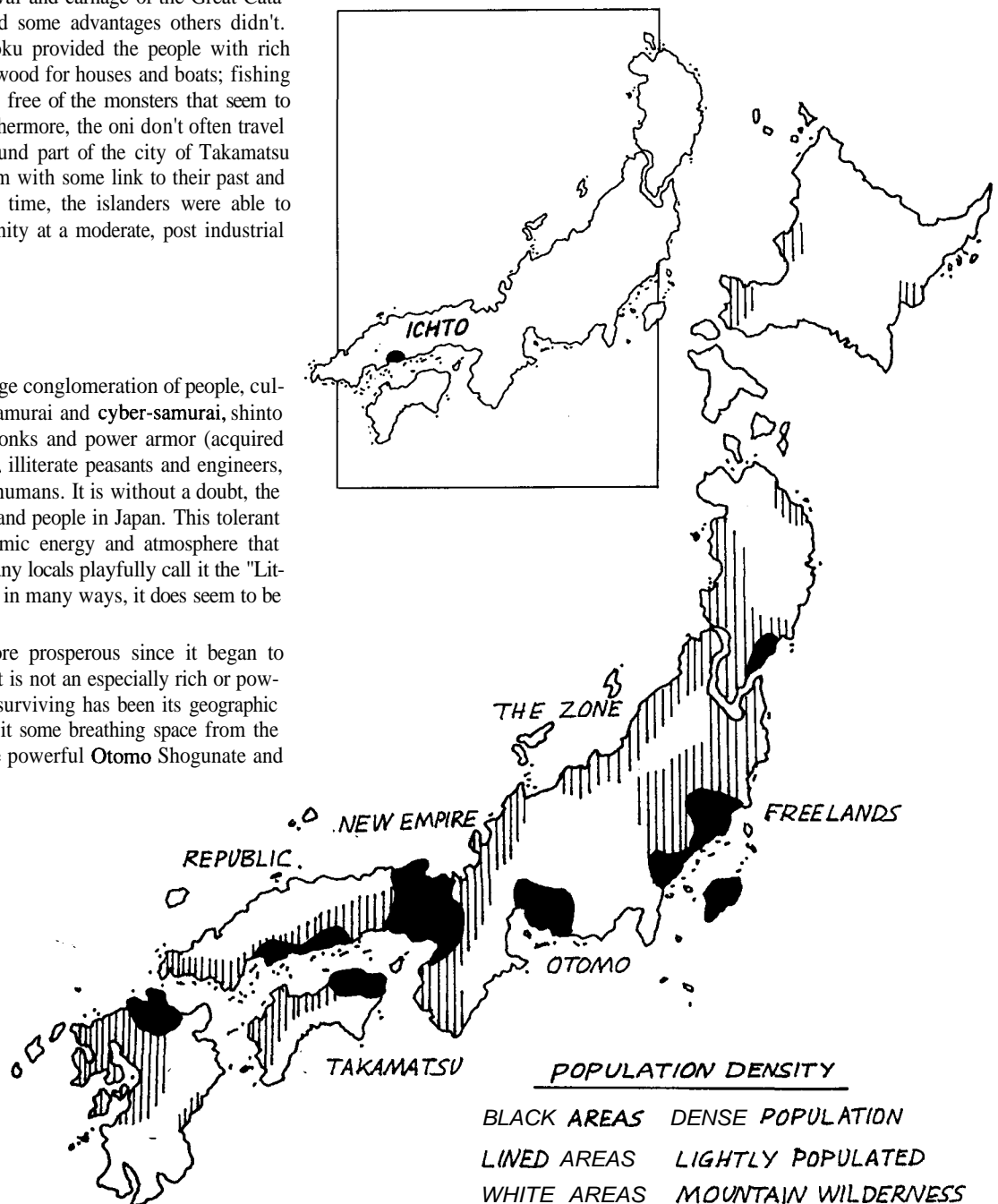

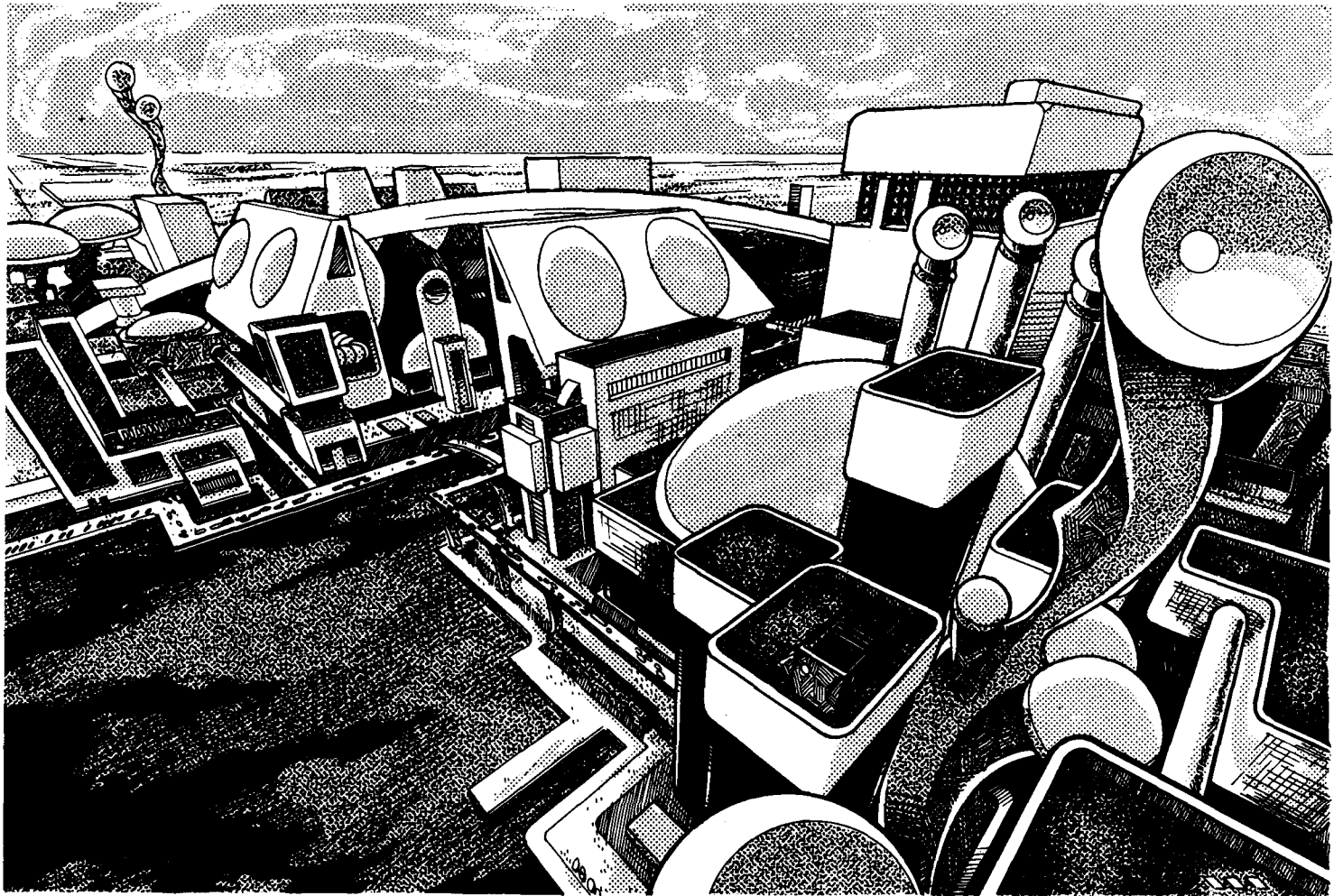

independent nation. Over the last 15 years, the Republic of Japan has tried every diplomatic means it could think of to get **Ichto** to join them, but to no avail. The Republic has considered using force to bring Ichto in line, but decided against it for fear that too many people would suffer and die on both sides. Considering how the Japanese race had almost been obliterated during the Great Cataclysm, and the number of inhuman monsters currently threatening the people of Japan (and the world), it seemed foolish to launch a war against one's own people. Besides, even a temperamental and belligerent ally such as Ichto, is better than none at all. Consequently, the Republic of Japan tries to ignore the disruptive and foolish things Ichto does and makes the best of a difficult situation.

**Ichto** is a high-tech city that has become an independent power and a feudal kingdom in and of itself. It is located near the Republic of Japan and was part of the area Rifted into a pocket dimension along with the city of Hiroshima and a few others.

Shortly after returning to Earth, the Ichto corporation seceded from the newly formed Republic of Japan. The robotics manufacturing giant preferred to make their own way in this strange, new Earth. The land holdings, manufacturing and development facilities of the Ichto Corporation were immense. The people of the city where its headquarters and factories were located were completely dependent on the corporation for their livelihoods. In addition, they were very loyal to Ichto which employed a full two-thirds of the city's residents. Thus, the citizens followed Ichto's lead and supported the idea of being an independent community.

Nobody was forced to stay or leave against their will. In fact, 10% of the current population lives in Ichto but works in the Republic of Japan and, in many cases, consider themselves to be citizens of the Republic. Within a few short years, the thriving community changed the name of the city to Ichto. As their land holdings grew and more of the

primitive people in the region turned to Ichto for employment, protection and guidance, the kingdom became known as the **Ichto Province**.

The corporate authorities run both the Ichto business and the province with efficiency and profit in mind. They welcome D-bees (but not oni) provided that these "aliens" don't cause trouble and obey the laws of Ichto (which are very similar to the Republic). However, D-bees can never become full **shareholders/legal citizens**.

**Ichto's** specialty is robots and power armor! They also produce some basic laser weapons and explosives similar to or direct "**knock-offs**" of **ArmaTech** items. The quality is good enough to be confused for the "AT" brand and often bear the AT identification even though they were not manufactured by ArmaTech.

#### **Services available from Ichto:**

- Cybernetic Implants (all systems)
- Headhunter Augmentation (partial cyborg)
- Partial and Full Conversion '**Borgs**
- Dragon 'Borg Conversions
- Cyber-Samurai**
- Juicer Augmentation

## **Foreign Relations**

**Ichto and the Republic of Japan:** The Ichto Province and the Republic of Japan engage in trade of all kinds, but have strained relations. The main areas of conflict lie in the areas of politics, corporate philosophy, land claims and ethics, especially in regard to the development, sale and distribution of technology.

Ichto is much more extreme about protecting itself and its assets, especially against non-humans. This has raised several claims of inhuman conduct against the Province. Claims which the Republic feels



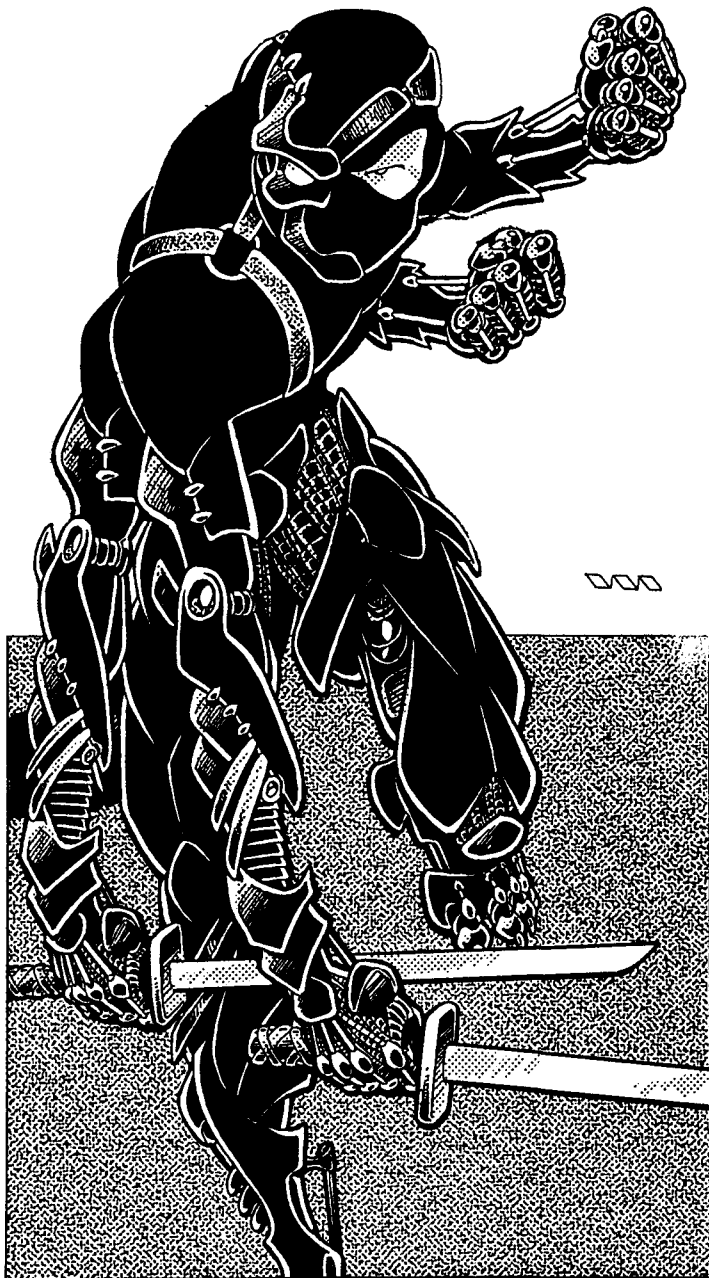

compromises its stand on human rights and which, if true, may incite enemies to strike against **Ichto**, its allies and all humans.

**Ichto** is much more aggressive in the areas of manufacturing and exploitation of opportunities, land and people. This has led to some frightening and bloody skirmishes with the **Otomo** and **Surusa** Shogunates, **H-Brand** (their commercial arch-rival), and other forces; human and superhuman.

Most disturbing to the Republic is **Ichto's** cutthroat and mercenary approach to marketing. The Republic of Japan feels that **Ichto's** indiscriminate sales of high-tech weapons and armor can only lead to disaster. The corporation sells to factions that the Republic considers dangerous, including unallied adventurers, mercenaries, criminals, et al, **Horune** pirates, and non-humans (as long as they don't threaten **Ichto**), as well as human factions on the demon and monster infested lands in China and Korea. As far as **Ichto** is concerned, a sale is a sale, without regard as to who the purchaser is or what the items may be used for or against. This policy has resulted in angry debates, threats, economic sanctions and hard feelings on both sides. Like a defiant teenager, **Ichto** acts all the more obstinate and impudent — they will do as they please and nobody will tell them otherwise! The corporation is tempting fate and provoking trouble on several fronts. Only time will tell if such prac-

tices will lead to their demise. For now, they prosper and wallow in their arrogance.

**The New Empire:** **Ichto** and groups from the New Empire clash regularly. The anti-technologists of the New Empire see **Ichto** as a dangerous and uncontrolled force with a hunger for power that is without conscience. Anti-technology forces frequently try to engage the technocrats in philosophical and ethical discussions about self-control, moderation and the dangers of their unconscionable actions. Most of their efforts have been peaceful discussions, protests and demonstrations. However, the authorities at **Ichto** have quickly become intolerant of the traditionalists and their "pathetic rhetoric" and have begun to treat them roughly.

**Ichto Corporate Security**, the elite members of the **Ichto** Corporation's private army, regularly engages in surveillance and harassment of anti-techies as well as threats, beatings as warnings and motivation, blackmail, framing the innocent and even murder. Over a hundred anti-techies are currently imprisoned, charged with industrial espionage, vandalism/destruction of property, sabotage, and a various acts of violence from assault to murder. In only 15% of the cases are the charges true or completely accurate. Recently, a law was passed making all anti-technologists illegal aliens, and forbidden to enter the Province. The preaching or protesting of technology or the **Ichto** Corporation is considered a criminal act and insurrection against the government and citizens of **Ichto**! Furthermore, law enforcement and defense agencies tend to treat such people with excessive force and brutality. This increasing animosity can only lead to more violence and turmoil. Some anti-tech extremists *have* engaged in acts of sabotage, violence and murder, have sent elemental and supernatural forces against the kingdom, and are every bit as bad as the most heartless corporate executive or defense officer. The New Empire and the Republic are surprised at how much **Ichto** is becoming like **H-Brand** and the **Otomo** Shogunate.

**Otomo & H-Brand:** In its arrogance, **Ichto** doesn't care about **Otomo** or **H-Brand** and is very vocal about inferior quality. **Otomo** and **H-Brand** hate them!

**Other Forces:** Most other forces regard **Ichto** as a potential threat to their survival, if for no other reason than the fact that they wield such incredible weapons of war and hold the secrets of past technology. **Ichto** knows less about the world than the Republic.

## Villages of Ichto Province

Population Breakdown: Typical village has 3D4x100 people. A few large ones have as many as 2500. The estimated total population of the villages within the **Ichto** province is 76,600.

78% Japanese Human

10% Non-Japanese Humans

12% Non-human

Note: 85% are semi-illiterate laborers or skilled craftsmen.

12% are illiterate with a basic education; read, write, basic math, and operate computers

3% are high, educated; can be any modern O.C.C.

Peasant and farm villages have sprung up around **Ichto**. These people look to the authorities for protection and consider themselves citizens of the *Ichto Province*, even the non-humans who are denied citizenship. The majority of these villages are low-tech, roughly equal to 19th Century Japan. However, this is mainly because they are poor and lack the knowledge and resources to develop high-technology or manufacturing. Most are illiterate farmers, fishermen, craftsmen, and laborers. They are diligent workers who are satisfied with their place in society, but marvel at the wonders of technology. Most are quick to learn and love to learn to read, write, and get a "tech" education. Sadly, most never get such an opportunity. Yet even the illiterate have learned to use modern tools, weapons and equipment, and all have come to respect the power that **pre-Rifts** robotics and technology has to offer.

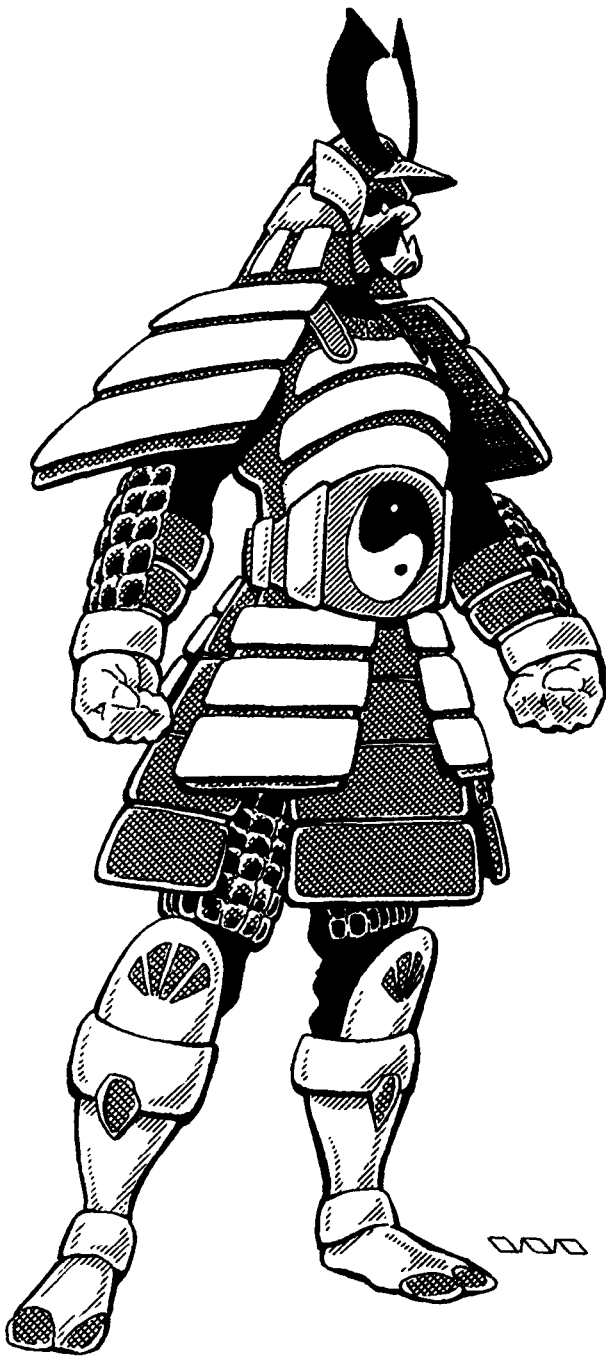

# Otomo Shogunate

## A Modern Industrial Kingdom & Home of H-Brand

Population Breakdown of the Region: 5,400,000 total; approximately 2.4 million live in the city of Otomo and another million at the H-Brand complex. The remaining population is located in smaller cities, and hundreds of villages scattered throughout the region. The average population of a city is  $2D4 \times 100,000$ , a town:  $2D4 \times 1000$ , and a village  $2D6 \times 100$ .

65% Japanese Humans

2% Non-Japanese Humans

28% Eta/D-bees

5% Oni & Others

This does not include the quarter of a million mercenaries it has attracted.

The Otomo Shogunate is a strange blend of tradition and magic, with several levels of technology, from **mid-20th** Century to the super-technology of pre-Rifts Earth. Most of this kingdom's technology was developed after the destruction of Japan, from survivors and those returning from abroad with whatever secrets they could carry. Acquiring old and new technology from various sources, the city of Otomo grew into a fairly modern city and became the ruling power for the last 200 years. Its people's ancestors were those who rejected the anti-technology **ramblings** of the New Empire and went out to rebuild a new, modern Japan. They too chose the military government of feudal Japan as their model for government, only their warriors consisted of **cyber-samurai**, 'borgs, juicers and augmented troops and mercenaries clad in modern versions of ancient samurai armor. One might consider them the exact opposite of the New Empire, with their mechanized warriors, smoke and soot belching factories, and total disregard for nature.

The mighty kingdom conquered many rival shogunates and slaughtered entire armies of demons. In fact, if Otomo has any one disadvantage, it is its geographic location. Expansion of the Shogunate has been stymied because it rests between the domain of the New Empire (which has proven to be too strong to conquer) and the demon filled territory known as The Zone. No other kingdom has faced more attacks and adversity from the oni than Otomo. In fact, it has only been through its technological superiority, mixed with magic and amazing tenacity, that the kingdom has been able to thrive.

Until the appearance of the Republic of Japan, Otomo, through its alliance with **H-Brand**, was the technological power on Japan. The **cyber-samurai**, ninja crazy, juicer and 'borg all originated at Otomo, brought to life by the people at H-Brand. With the Republic and **Ichto** in the picture, it has been reduced to number three, with **Takamatsu** hot on its tail. This does not please the warlords of Otomo, or the corporate moguls at H-Brand. Too long have they been forced to bear a disproportionate amount of hardship and been held back from their rightful place as the real power of Japan. They will not take third or fourth seat to these new interlopers. Thus, the shogun of Otomo and his generals are taking drastic steps to destroy their competition. This includes supplying the enemies of the other kingdoms with weapons, unleashing their ninja to engage in sabotage, building an army of mercenaries to raid the Republic, and even making a pact with the demons from The Zone to invade the New Empire!

If these measures seem extreme, it's because they are, and either the Otomo Shogunate will manage to diminish the level of power and holdings of its rival, seize them for itself, and rise to the power it has always dreamt of through treachery, or it will be obliterated. This is unfortunate, because even though the Otomo Shogunate is a brutal dictatorship and a land of decadence and cruelty, it is the home of hundreds of thousands of innocent people and has been a major obstacle to the oni invaders for hundreds of years. If the Shogunate cripples itself through its mad dreams of conquest, it will surely fall to the demons. If it does, the innocent inhabitants will be enslaved by the oni who will sweep down from the mountains. This will expand The Zone and completely divide the island of Honshu in half. Without Otomo, more stress will be placed on the defenses of the New Empire, and if the evil Shogunate's plans work as efficiently as they believe, Takamatsu will be laid to ruin and the Republic of Japan severely weakened. This could give the oni the opening they need to conquer half, if not all, of the New Empire. The mad scheme for conquest will unfold over the next five years. They already have most of their plan and players in place, and have begun to make their move.

## The Mad Scheme

The master plan of Otomo is one of secrecy, subterfuge and duplicity. It should be years before anybody realizes that it is Otomo behind the undercurrent of tragedy and war that will begin to wash over the land.

**The New Empire: Otomo** and the New Empire consider each other enemies and are in a constant state of war. To the anti-technologists of the New Empire, **H-Brand** and the Otomo Shogunate represents *everything* wrong with technology and the destructive, cold-hearted inhumanity that it breeds! Unlike the subtle campaign of lobbying, philosophical discussion and peaceful protests waged against the Republic of Japan and **Takamatsu**, the strife between the Empire and **Ichto** frequently erupts into violence and bloodshed.

This situation is compounded with generations of animosity, armed conflicts, and all-out war between the two kingdoms. These wars have been the result of Otomo's campaigns to conquer territory belonging to the Empire, bids for power, and moral and philosophical issues. The military and government of the Otomo Shogunate are aggressive, arrogant, callous and use technology as a weapon against their fellow man. Their silent partner, H-Brand, is equally hard edged and merciless in its quest for personal power and wealth. Its industrialized cities are filled with factories belching dirt and smoke into the air. They mock the faith and goals of the Empire and conspire to bring the nation to its knees by causing unrest and supplying its enemies with deadly weapons. In addition, they exhibit contempt for the supernatural, spirits and gods whether they be good or evil.

Under Otomo's new scheme for conquest, they have made a non-aggression pact with key oni warlords and have also promised to take no action against them for assaults on the borders of the New Empire. Meanwhile, Otomo prepares its own army for war and is building a huge mercenary force. But an invasion will not occur until they have undermined both Takamatsu and the Republic of Japan. **Note:** It is impossible for Otomo to conquer more than a quarter of the New Empire's territory. The question is, what are the oni doing while the human nations are at war? Both the New Empire and Otomo will be vulnerable. If the oni live up to their non-aggression pact, they could conquer part of the Empire (the northern mountain range). If they break their agreement with hated the enemy, they could break through Otomo's defenses and tear that kingdom apart.

**Takamatsu:** The Otomo Shogunate, H-Brand and Takamatsu have had strained trade relations for generations. Takamatsu has always considered Otomo to be unreliable and dishonest, however, with the New Empire between them, and the cries of the poor ringing in their ears, the leaders of Takamatsu have been their supply line for decades. In the last year, the Otomo Shogunate has increased its orders by a hundred fold, obviously stockpiling supplies. Recently, the shogunate expressed its deep dissatisfaction with **Takamatsu's** trade practices with the Republic of Japan, and insisted they cease all contact with them. Takamatsu's leaders refused, so Otomo has stopped purchasing product and has a huge outstanding balance that they refuse to pay.

This small and peaceful kingdom is the central block in Otomo's treachery. If Takamatsu falls, it weakens the overall strength and defenses of the region, but more importantly, it cuts off the vital supply line to the Republic. If the kingdom completely crumbles, Otomo ninja, followed by an occupation force, will seize control and use the Takamatsu dimensional gateway to acquire the resources to supply the Otomo war machine. The island can also serve as a staging ground for attacks into both the Republic of Japan and the New Empire.

To slowly destroy Takamatsu, Otomo has dispatched hundreds of its tech, crazy, juicer and **'borg** ninja to engage in acts of industrial sabotage and to create anarchy. They will **incite labor** strikes, cause riots, engage in assassination, of its leaders, blackmail, robbery, murder and wholesale destruction of docked ships, factories, warehouses, etc. A similar campaign will be launched against the Republic of Japan, but it is likely to be (much) less successful. **Note:** Also see **Horunepirates**.

**The Republic of Japan:** The Republic of Japan no idea how irrational Otomo can be or what they are planning. They know the kingdom dislikes them and have made veiled threats to Takamatsu, but other than this, they consider the Otomo Shogunate to be nothing more than a loud-mouthed bully, and disreputable arms dealer to second-rate nations.



Unknown to the authorities, H-Brand has dispatched a number of its ninja clans to infiltrate and sabotage the inner circle of government and industry, just as it has begun in Takamatsu. The difference is that the Republic of Japan is much larger, more organized and capable of finding these spies and assassins and dispatching them. Despite the delusions of the power brokers at Otomo, they have greatly underestimated the resources of the Republic. Their "shadow legion" will barely make a dent against the Republic, let alone demoralize or undermine the structure or power of this strong, new nation. This huge flaw in their plan could be their undoing, unless the Republic is too slow to help Takamatsu, and it falls to the Shogunate.

**Ichto Province:** Otomo hates these guys too, but believe that they can worry about them later. At the point that Otomo reveals itself in all of this, they will have sent armies to Takamatsu and the New Empire. At the same time, they will warn Ichto to stay out of this affair and be spared. This makes Ichto a wild card. If they stay neutral, things will unfold as they may. If they toss in with Otomo, it will increase their odds of destroying Takamatsu and seizing and conquering some portion of the New Empire. Such an alliance will also draw the line in a protracted conflict and make them mortal enemies of the Republic of Japan! If they throw in with Takamatsu or the Republic and the New Empire, Otomo's dream of conquest is doomed!

**H-Brand:** Completely endorses this plan, but will become nervous when they realize their ninja spies and saboteurs have no impact on the Republic of Japan and will push for a retreat and hatch a plot to cover Otomo and their involvement in the affair if Takamatsu does not fall. Always one to cover their options, they have accelerated negotiations to build a factory and branch office at the Yukimura Shogunate on the borders of the **Freelands**. They have also hidden assets and have placed their private army on alert. Otomo knows about the Yukimura operation, but believes it is being established only to have better sales with the kingdoms, mercenaries and adventurers in that region.

**The Zone — Demon Hordes:** This is the New Empire's oldest and greatest enemy, thus they were quick to agree in participating with the invasion plans of Otomo. To this end, several key oni warlords have signed a mutually binding nonaggression pact with the Otomo Shogunate and have agreed to "soften up" the Empire and distract their atten-

tion from trouble at **Takamatsu** by launching increased attacks along the northern border. In return, Otomo has agreed to acknowledge the borders of their demonic kingdom, and, when the invasion is launched, to let them take the northern corner of the New Empire.

Whether or not the oni will abide by the agreement is unknown, but the idea of grabbing a sizable portion of their most hated **enemy's** lands and watching them squirm under **Otomo's** assault are incredible temptations.

**The Freelands:** Otomo has recruited over 200,000 mercenaries, bandits, thugs and ainu from the northern wilderness to invade the New Empire. The invasion shall be orchestrated in such a way as to not implicate Otomo. In fact, if the oni cooperate as promised, it will appear as if it is the oni or a new human kingdom that is invading. Although the majority of the outcasts in the Freelands dislike the New Empire, some will rally to its defense, while others will recognize Otomo as a greater evil and also strike against it. However, the vast majority are likely to stay out of the conflict.

**Horune Pirates:** A deal has been made with the **Horune** to launch attacks against Takamatsu vessels coastal cities and villages. The Horune can keep whatever booty they capture, take slaves, and will be subsidized by Otomo to cover most of their expenses. When Takamatsu falls, they will be given preferred status in regard to continuing trade and a free hand at plundering the coastline of the New Empire and the Republic of Japan. The **Horune's** involvement, in concert with the sabotage by the tech ninja, should help to destroy this fragile and peaceful kingdom. **Note:** The only thing that can save Takamatsu is intervention by the Republic of Japan (and/or the New Empire or **Ichto**) with serious troop support. The small kingdom is ill prepared for war, especially since it will be the main focus of attack on several fronts.

**The Domain of the Gods:** The gods tend to stay out of man's wars, but if the gods of light should take sides in this conflict, so will the gods of darkness.

**Splugorth and Other People:** Otomo doesn't know or care about the Splugorth, Triax, NGR, CS, the Naut'yll, Tritonia, China or any other distant, foreign powers.

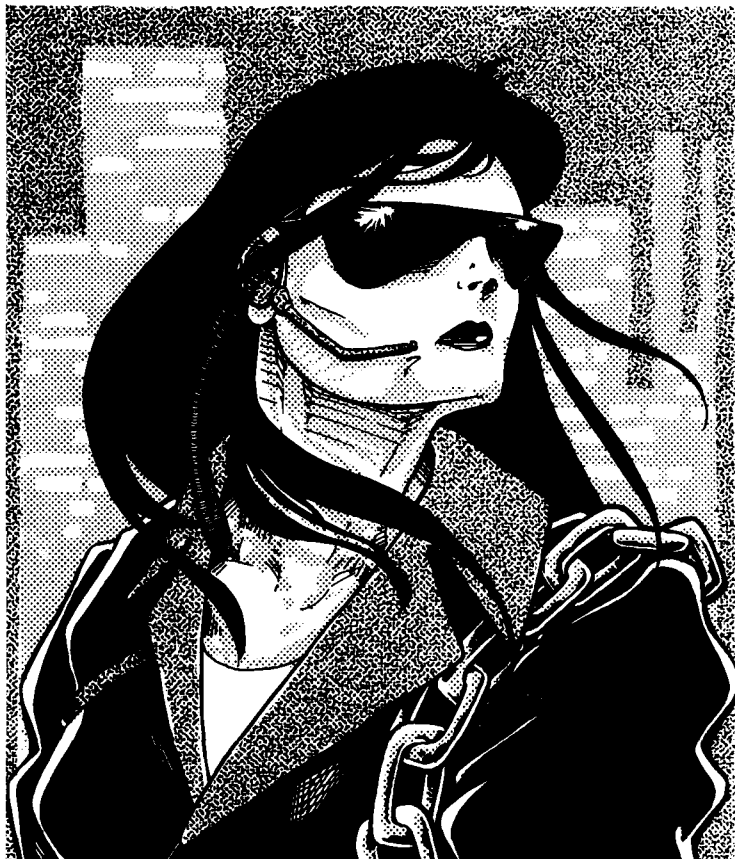

# H-Brand Corporation

**Population Breakdown of the Region:** One million, but 80% are laborers in the H-Brand factories and warehouses. 19% represent engineers, technicians, skilled labor and low ranking corporate executives. Only 1% hold the reigns of real power within the corporation. Most (83%) of the executives and workers are extremely loyal to the corporation.

65% Japanese Humans

2% Non-Japanese Humans

30% Eta/D-bees

3% Oni & Others

H-Brand is an independent power within the Otomo Shogunate. It is self-governing under a corporate power structure, with its own laws, code of conduct and ethics. It enjoys its autonomy and respects the authorities and laws of the Otomo Shogunate, seldom interfering with that government except when the situation affects their profits. H-Brand is an aggressive, mercenary corporation dedicated to amassing wealth and power. They have a formal alliance with Otomo and the two have had a very successful symbiotic relationship for nearly 200 years. H-Brand supplies the Otomo government with high-tech weapons, armor and equipment at 20% below cost, they help defend the Shogunate if it should fall under attack (which is ultimately in H-Brand's best interest anyway), and pays the kingdom a 10% royalty based on all sales. In return, the shogunate lets H-Brand operate with full autonomy but under the auspices of its government, preventing competitors and enemies from waging attacks against the corporation, unless they want to declare war against Otomo as well. This diplomatic immunity has given H-Brand security and clout when dealing with other kingdoms and engaging in disreputable practices (like selling weapons to the enemies of other kingdoms, supplying unallied mercenaries and even selling on the sly to eta and ainu). This strange alliance has actually worked out extremely well for both Otomo and H-Brand. Consequently, both are delighted with each other, work well together, are supportive of each other, and are reasonably loyal to each other.

To protect its assets, H-Brand has its own army — in fact, its forces are only 10% smaller than the Shogunate's! The most noteworthy military troops include:

11,200 elite foot soldiers (3000 full conversion 'borgs, 1100 dragon 'borgs, 2500 ninja juicers, 1200 ninja crazies, 1400 cyber-samurai and 2000 grunts)

4000 power armor troops

1200 robot troops

16 rebuilt G10 Glitter Boys and five G10A2 Hawkeyes.

Plus access to secret tech-ninja clansmen and mercenaries.

These forces are often hired out as mercenaries to other kingdoms, merchants and corporations (including some in the Republic of Japan). H-Brand tries not to support governments or groups that might be considered to be a threat to H-Brand or Otomo, but have been known to cheerfully supply weapons (if not troops) to both sides of a war. If they should ever encounter **Naruni Enterprises**, the two will recognize many of the same self-serving traits, ethics and methods. In fact, Naruni Enterprises might even offer H-Brand employment in its elite transdimensional sales **corp** and as a licensed NE manufacturer and distributor in Japan. Of course, it is also possible that the two would become bitter competitors.

The most common mercenary work typically involves hiring out small groups of special squads (8 to 10 per squad) or platoons (40 troops per platoon) to clients like small businesses and corporations, merchants, traders, **warlords/shoguns**, criminal organizations, and the occasional individual. However, entire companies and even brigades are also usually available. The army is also used to protect and advance H-Brand's holdings. In addition to serving the corporation as needed,

squads, platoons and the occasional company are sent on reconnaissance missions, investigations, espionage (spying, infiltration, sabotage, theft, etc.), as well as raids against other kingdoms and forces (usually inhuman) operating on the Japanese islands, Taiwan, Korea, Manchuria and the Eastern coast of China. Since H-Brand and most of the forces in Japan don't have a navy to speak of, most raiding parties fly over to the other islands or mainland or use very basic boats or ships like those described in *Rifts Underseas*.

**H-Brand services include:**

- Partial and Full Conversion Borgs
- Headhunters
- Cyber-Samurai
- Crazies
- Juicers
- Ninja Juicers
- Ninja Crazies
- Crazies



## Other Places of Note

**The Zone** has been mentioned many times because it is the domain of the oni. It is predominately mountainous wilderness that is an inhospitable environment for humans. The wild regions of The Zone are far from the peaceful settings found in similar areas of the New Empire and Republic of Japan. Despite the pleasant appearance the forests of the Zone are sinister places where demons and monsters hunt and feed. The few human villages that exist are enslaved by vile supernatural forces that prey upon the helpless humans at their leisure. Even the well-trained and equipped warriors of the Republic are at a disadvantage in these areas where large bands of oni and kappa are in control. Although supernatural creatures currently hold sway in the wilderness the forces of humanity are slowly pushing back the monsters, liberating enslaved villages and reclaiming the territory.

These creatures are at heart primitive tribal hunters whose lives revolve around the hunt, with humans rather than animals as their prey. Generally speaking the monsters are squatters, settling an area for as long as the hunting is good and moving on once the food sources are depleted. Various tribes will fight amongst themselves for control of the best hunting grounds, even against tribes of the same species. If the area is large enough there will often be dozens of tribes or clans, but should hunting drop a war will ensue for dominance. Many fight amongst themselves for territory, power and dominance. The largest and most organized tribes are the **equivalent** of small armies numbering into the thousands. They are located in the southern portion of The Zone where they constantly test the borders of the New Empire and the Otomo Shogunate. Fortunately for the Japanese forces, the typical tribal units are small and disorganized. In a direct confrontation there are few tribal

groups that can stand toe-to-toe with modern power armor units or or a group of elite samurai or warrior monks.

Infrequently, the monsters are gathered into great armies by powerful oni war chief, mystics, dragons, sorcerers and even dark godlings and gods. When this happens, the oni go on the warpath and sweep down from the mountains to invade the domain of man in mass. This also works up the smaller tribes and often incite them to war and mischief. See the monster section for more data about The Zone, oni and other denizen of this region. The ainu, more oni, **elementals**, gods and supernatural beings will be described in an up coming companion book for **Rifts Japan**.

**The Domain of the Gods** is located on the desolate island of Hokkaido. Few humans or D-bees live there, although a few tribes of ainu prosper. Oni, dragons and a handful of other supernatural beings also share the island. Unknown to most humans, a second Millennium Tree is located in a secluded mountain valley, protected by the gods of light.

**Surusa** is a small feudal kingdom of samurai, magic and limited technology (H-Brand purchases) located on a large island that was once a peninsula across the Bay of Tokyo.

**Yukimura** is another small shogunate located near Surusa and the sunken city of Tokyo. It is a den of iniquity and a haven for mercenaries, pirates and outlaws.

**Toshie** is a militant shogunate of fanatical anti-technologists located near Yukimura. The two have squabbled and fought for generations.

## Other Islands of Japan

To the south of the main island are two dozen small islands, some survivors of the cataclysm, others created by it. They are virtually untouched by the hand of man (or any sentient beings) and are blanketed by natural vegetation.

**Okinawa and the Undersea Naval Platform:** The Undersea Naval Platform was built by the Japanese Empire prior to the coming of the Rifts as a prototype for space stations. With many of the same problems to be overcome, an underwater station was a logical place to begin testing designs and systems for space platforms. It was destroyed in the Great Cataclysm, but has been partially salvaged and rebuilt by **Horune** pirates who use it at part as a secret pirate base.

## Russian Coast

The coastal area of the once mighty Russian Empire was humbled by the unforgiving Pacific Ocean during the Great Cataclysm. Huge sections of the coast were reclaimed by the ocean and submerged underwater. Decades later, the new coastline is dotted with fishing villages. Many of the fishing villages are no more than shanty towns that survive by luck. Most of these settlements have no industrial level technology, although a handful have rediscovered steam power and the basics of locomotion. The average fisherman uses a simple wooden or scrap metal boat with a sail. Only a couple have boats with low horsepower motors and one or two **Pre-Rifts** trawlers.

Several small pirate organizations ply the waters along the Russian coast and down into the Sea of Japan and the China Seas. Most of these are small operations with 1D4 vessels to their credit, none of which could survive a journey deep into the Pacific. Thus, they cling to the coastline, conduct coastal raids, and prey on fishing boats, the occasional traveler and other pirates. Most do not have high performance assault ships or great magic, so they rely on souped up ships with light armor plating and a couple of weapon systems. About half have 1D6 water or air warlocks on board (average level 1D4+1). When combating large, determined enemies, the only chance these pitiful vessels have is dumb luck or the mercy of their opponent — the Horune have sunken scores of these ships and sell the crews into slavery.

**Note:** Human and demon pirates from China, Korea and Taiwan also sail these waters.



RR  
PS  
95

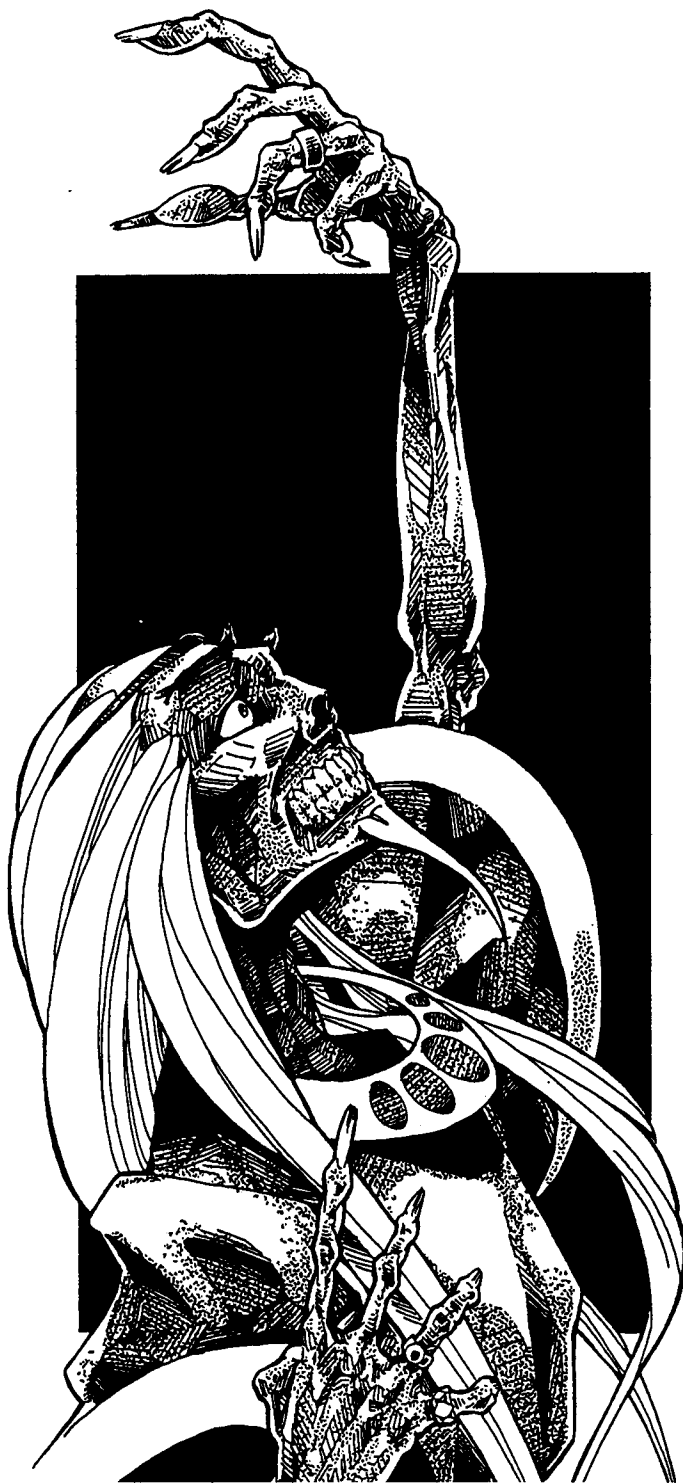

## Mainland China

Mainland China is a living nightmare. If Erin Tarn should ever visit, it will remind her of **Wormwood**, a planet dominated by demonic beings. Uncounted millions of humans and **D-bees** suffer under the yoke of slavery at the hands of inhuman monsters. Those who remain free are hunted desperadoes or the lucky few that have remained hidden. **Note:** Much more will appear about China in future world books.

## Korea

The country that was once the Korean Empire, like most of Asia, was devastated by the coming of the Rifts. Less than three percent of the population survived the tragic events of the Great Cataclysm. Since that time, the few surviving humans have banded together in tiny villages scattered throughout the country, mainly along the coast. Along the stretch of coastline, there are dozens of shanty towns filled with fishermen and their families. These towns are similar to those found

along the Russian coast except that they are even more pathetic and lack any type of advanced technology.

Ninety-eight percent of Korea is an empty wilderness that even the demon hordes of China have not yet populated. Magic and the supernatural are commonplace in the wilderness. It is here that the majority of monsters and mystical beings make their homes. Among the creatures living in the wild there are faerie folk, tengu, goblin spiders, imps, goblins, trolls, **elementals**, and tribes of oni. Even the gods are said to visit this comparatively quiet wilderness.

A meager population of as many as six million humans may live in the entire country, with three times as many **D-bees**. Tiny villages are found throughout the wilderness where the people rely on farming for their livelihoods. They are subject to constant attacks by supernatural predators, so few of these villages have any hope for continued existence.

There is one area, centered around the former city of Seoul, that has managed to prosper. A cluster of more than sixty villages are found in a 50 mile (80 km) radius where the humans enjoy safety from the demons and monsters that plague the rest of Asia. Rumor has it that the territory is kept safe by the presence of an incredibly powerful warrior known to the people as **Master Khan**.

Khan is actually an ancient **chiang-ku** dragon of considerable power. Disguised as a human priest, the dragon built a monastery where he began to instruct selected humans in the martial and mystic arts. Not only were they trained to fight, but those monks who proved worthy were given magic tattoos, creating an effective force of **T-men** martial artists. There is a total defense force of 2,000 tattooed warrior monks to protect the entire population of 98,000, in addition to Khan and a few other supernatural allies (including a pair of 8th level, **kumo-mi** dragons). Though they are outnumbered by the surrounding monster population, they are still tough enough (or beneath notice) that the local demon lords have not bothered to attack them.

## Taiwan

The people on the island of Taiwan were completely obliterated in the Great Cataclysm. It has only been in the last hundred years that non-humans have begun to repopulated the island.

## Philippines

The Pre-Rifts culture of the Philippines was completely wiped out during the cataclysm. Over 99% of the population died, leaving behind weary survivors who lasted only long enough to prove easy prey for dimensional invaders. All that remains of the former civilization are a handful of ruins on the main islands.

Of the 7100 islands that once constituted the Philippines, more than half have since been swallowed by the Pacific Ocean. Those islands that remain have been dramatically reduced in size, leaving nothing more than a scattered chain of small islands of the one-time Philippine Empire.

Before the Rifts erupted, there was a large naval base of the American Empire on the main island at Subic Bay. The vessels stationed at the base were all sunk. As of yet, they have not been discovered by freelance salvagers or pirates. After resting 300 years on the bottom of the sea, they offer little of value other than scrap metal and some pre-Rifts artifacts.

## The Japanese Triangle

Southeast of Japan, between the Philippines and Hawaii, just touching Guam, is a dimensional triangle similar to the famous Bermuda Triangle in the Atlantic Ocean. Much like that frightful sea, this triangle is also the source of unnatural storms, dimensional anomalies, the appearance of random Rifts, and horrible monsters from other worlds. **Note:** See *Rifts Atlantis* and/or *Rifts Underseas* for information about *Demon Seas*.



# Ley Lines of Japan

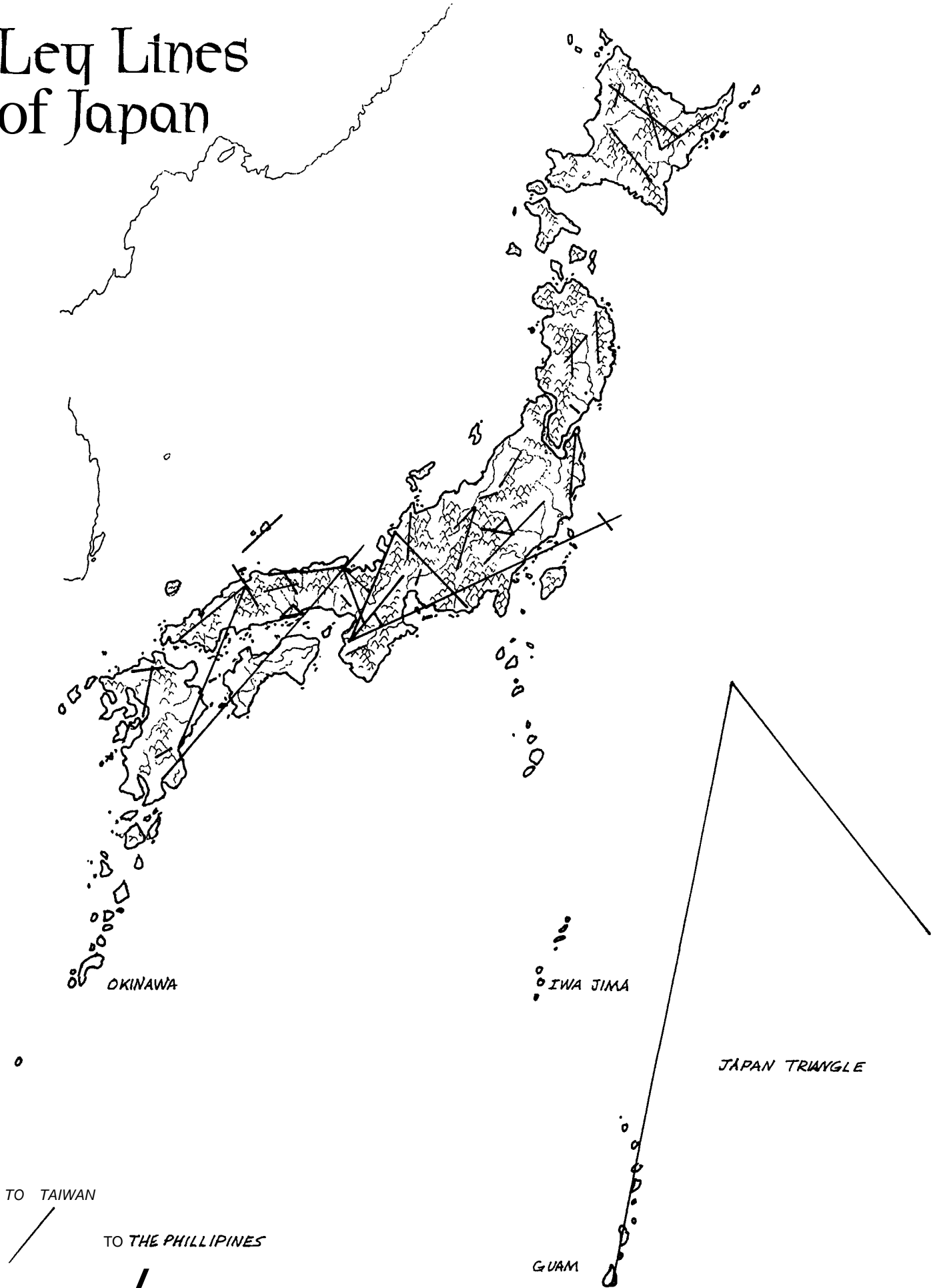



## Kyoto Millennium Tree

By Kevin Siembieda — parts excerpted from *Rifts England*

Millennium Trees, also known as the "Trees of Life," are incredible giant trees that tower over a thousand feet (305+ meters) tall and defy the laws of botany. The plants feed on P.P.E. and have appeared at only a few dozen ley line junctions around the world. The mystical trees show no seasonal cycle nor reaction to even the most dramatic changes in climate; in winter and summer the trees stay in full bloom. One has appeared in the North African desert and another flourishes in the snow covered forests of Norway. The tree's sole source of nourishment is potential psychic energy (P.P.E.) which is harnessed within its massive body, making its trunk, leaves, limbs, and bark mega-damage structures. This would be miraculous enough on its own, but the giant, beautiful tree seems to have a subtle intelligence and may even be a quiet, benevolent god or other supernatural force of good.

The Shinto priests insist that the tree is the embodiment of a powerful "kami" — a word that represents gods, spirits and supernatural forces. Shinto is Japan's oldest religion and has always seen "kami" in awe inspiring, natural formations such as trees, mountains, rocks, waterfalls, and people and places of great beauty or power. With the Coming of the Rifts and the return of the ancient gods and oni, many of the Shinto beliefs and legends have proven to be true. However, in the case of the "Sacred Tree" or *himorogi*, the Shinto are not alone. Buddhists, taoists and numerous other religious orders concur that the *himorogi* is the living embodiment of beauty, strength, and magic. The fact that it is located in the rebuilt holy city of **Kyoto**, in the shadow of Mount Fuji, has not only made the location a religious **mecca**, but has helped to make Kyoto become the capital city and heart of the New Empire. Kyoto is a city of over one million people, with thousands of smaller towns and villages radiating away from it "like light from the sun."

The Shinto priests, **bishamon** fighting monks, and **sohei** warriors all have major temples and/or monasteries located in the city and within a mile of the great tree. One Shinto order has their monastery inside the tree. In fact, the tree's great "gifts" include hollow nodules and pod-like bulbs ideal for human habitation. The Shinto priest, smile wisely and point out that the *himorogi* has no *natural* use for these formations and that the Millennium Tree has consciously created them as an invitation for all peace-loving creatures to come and live in the safety of her embrace. Indeed, the oval openings in the bulbs or pods are ideally positioned as doors and windows. Formations inside function as staircases, platforms, space dividers/walls and balconies. The priests also claim that no demon dares to enter the shadow of the great *himorogi*; indeed, no oni, imp or evil spirit has ever been known to invade a single home of the 150,000 people who live *in the tree!*

The magic tree is known to have existed in Japan for at least 260 years. How it got to Earth or where it came from is a mystery. Shinto priests claim that the kami came down from heaven to "give the survivors of the *Bachi* (the "Divine Punishment," anti-tech words traditionalists use to describe the Great Cataclysm) roots and the strength to rebuild." There are numerous myths and stories about the Great *Himorogi*, but ultimately, the Millennium Tree is an enigma that defies explanation. Its origin, nature, function and existence are likely to remain a mysteries for generations to come.

Millennium Trees cannot (or will not) communicate with other life-forms in a way easily comprehensible to humans. The tree doesn't move or make gestures, it doesn't magically write or make symbols, it can't use words to talk and express itself, nor does it use telepathy or empathy; although **empaths** and telepaths do sense positive feelings

emanating from the tree. Even the **yamabushi** and Shinto priests, who claim to speak to the earth and **kami**, cannot communicate with the great himorogi, although they too report "good spirits" and positive emanations.

The Millennium Tree does show its cognitive sense and "good spirit," however, by responding to people's needs and fears in subtle ways. The yamabushi and shinto agree that the "tree houses" are one excellent sample, but there are many others. The tree frequently performs acts of healing and instills visions of inspiration or warning to many of the priests, monks and people who reside in and under its branches. One might argue that these are random events that occur to people with magic or psychic sensitivity (the tree is, after all, resting on a ley line nexus). However, evil, greedy and self-serving people *never* enjoy such insights, while there have been many cases of well-meaning heroes and hard working farmers with the psychic sensitivity of a rock who have. This would seem to indicate some level of awareness and deliberate action. The Shinto call these acts of healing and visions "gifts" from the sacred tree. The tree also provides others with "gifts." Mega-damage leaves, twigs, branches and bark will drop from it in answer to prayers and humble requests (within reason and limit). These things can be used to make M.D.C. armor, clothing and weapons. Most twigs and branches possess specific magic powers and serve as mystic staves and wands. Of course, the person must realize the special powers of such a seemingly ordinary item. However, the tree does not give away or bestow such gifts to every good-hearted or needy person who steps under its branches.

The Shinto priests say that the tree has no or little psionic power other than the ability to sense good and evil, so it cannot read minds to determine the sincerity, truth, intent or goodness of an individual. Instead the tree *listens* to everything said under its branches (magically understands all languages). The following is a Shinto teaching that explains, to some degree, the "gifts" and wisdom of the Millennium Tree.

"The Great Tree hears all and remembers all. It can tell my voice and yours, from the returning pilgrim who visited once a generation ago. Its leaves are like 10 million ears that hear the softest whisper beneath its branches. In its infinite wisdom, the sacred tree can tell from a person's voice the truth or lies that spill from his tongue. And know this, the tree has friends. The humble, the non-assuming, those who do not come only to ask for gifts. People it knows and trusts. And though the Great Tree has shown great generosity in its gifts of protection, and has given of itself with its own flesh in the way of leaf and twig, branch and bark, it does not give infinitely. For the Great Tree knows that man must find his own path in the world and he must not become so dependent on the Great One that he stops doing for himself."

The priest is correct. The Millennium Tree is a sentient and benevolent being who hears and remembers everything said around it. It can identify specific people by his or her voice pattern (frequency, pitch, tone, inflections, choice of words, etc.) and by this means, can also determine if the person is under stress, nervous, angry, sad, happy, sincere, or lying (90% accuracy if the person is known, 45% if not known). One must remember that the entire tree is alive and aware, thus it knows everything that is happening in, on and around its gigantic body. It enjoys the songs of birds flying overhead, the chatter of two squirrels arguing on a branch, the silly games of playful faeries and the whispers of adventurers resting under its shade. Furthermore, it hears the noises carried on the wind, tastes the ash of a distant fire (also carried by the wind), and recognizes the fear and distress of the many animals that visit and live on its body. Likewise, it feels the vibrations of the earth, including the gallop of horses, the rumble of vehicles, the march of soldiers and shock waves from explosions. Additionally, it can feel when the mystic energies of its connecting ley lines are being used, as well as when and where a Rift has opened along any of its ley lines. As a result, it is not likely that the tree can be caught unawares. This enables it to protect its friends, inhabitants and self from danger.

As for the giving of "gifts," the tree is much more likely to intercede and help a *friend* than a stranger, including a friend's pleas for help on

behalf of a stranger. This is where the Shinto priests, monks, yamabushi and other "friends" of the tree can be vital allies. The Kyoto tree has come to trust the clergy who live nearby and among its branches and bestows them with famous demon fighting staves of the **bishamon** and **sohei**, as well as materials for armor which the clergy give to members of their order and special heroes. The people of Kyoto have great respect and reverence for the Sacred Tree and would never consider trying to forcibly remove a branch or leaf. They also realize that, as the priests teach, they must find their own way in the world, and are grateful that the Millennium Tree offers them any protection and help at all. Consequently, for over 200 years, the Kyoto Millennium Tree and its relationship with the human population that has grown up around it, is a healthy and amicable one.

The Sacred Tree only withholds its gifts from characters of evil alignment, and even then, it may provide healing if such a gift is asked in behalf of the **scoundrel** by a trusted friend.

## The Average Millennium Tree

### Statistical Data

**Typical Tree Size:** 1000 feet (305 m) plus 4D6×10 yards/meters tall.

**Alignment:** Always principled or scrupulous good alignment. The alignment can be detected by using a see aura, sense **good/evil**, and object read (an object read will only detect the alignment —**nothing** more).

**Note:** No seeds. There is no known way to grow a Millennium Tree. Branches, twigs, and leaves that have fallen or are removed from the tree can NOT be made to grow roots and turn into a tree. However, a wand or staff can be given back to the tree by pressing one end into the trunk, where it will magically reattach and turns back into an ordinary looking branch.

### Average M.D.C. by Location:

Leaf Stem — 6

Leaf — 30 each

Twig (wand) — 200 each

Small Branch (cane or staff) — 400 each

Medium Branch (large staff) — 1000 each

Large Branch — 4000 each

Giant Branch — 9000 each

House Burl (small) — 5000 each

House Burl (large) — 10,000 to 20,000 each.

Main Body/Trunk — 50,000

### The Millennium Tree also has special properties as follows:

- Mega-damage structure: Impervious to normal weapons, fire, heat, and cold.
- Impervious to diseases and chemical attacks — does not need water or clean air to live.
- Vulnerable to mega-damage attacks, including explosives, rail guns, most high-tech weapons and brute strength.
- Magic energy attacks, including fire, dragon's fire, lightning and energy blasts inflict half normal damage. Blows from rune weapons and most other magic weapons inflict full damage.
- Protected by its inhabitants and friends.
- A devastating ley line storm erupts when the tree is under attack (singling out the attackers).
- P.P.E. area explosion when even a leaf is cut or twig broken.

**Locations of "Known" Trees:** Millennium Trees are most commonly found in western Europe and parts of Africa. There are 11 known trees in England, four in Scotland, five in Ireland, seven in France, three in Greece, two in Belgium, two in Switzerland, two in Germany, and one in northern Norway, Poland, Austria, Italy, Egypt, Libya, Algeria, Kenya, and the African Congo. Additional trees may

exist in other locations, especially in Africa and Europe. As far as westerners are concerned, there are no Millennium Trees in Asia or the Americas. Nor are there any **known** to exist in northeastern Europe, India, Australia, or New Zealand. However, their knowledge of the world has some rather large gaps so they do not know about the tree at Kyoto. Furthermore, most people living on the Islands of Japan don't know that a second Millennium tree exists in a mountain valley on the island of Hokkaido, the Domain of the Gods.

**Note:** See *Rifts England* for some additional information and theories about Millennium Trees.

## Means of Defense

The Millennium Trees have three major forms of self defense: localized energy explosions, protectors and ley line storms.

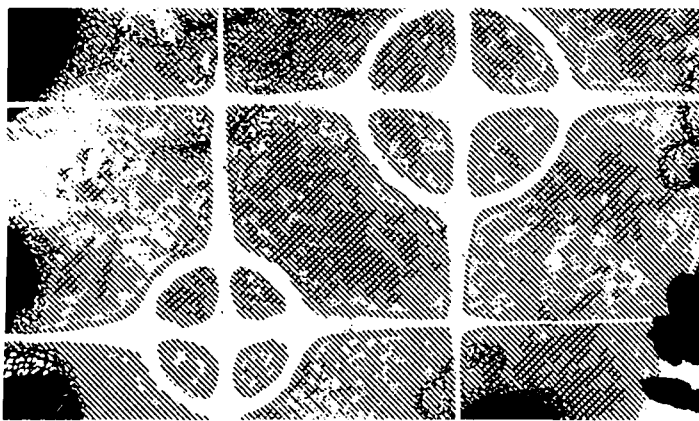

## Energy Eruption

Millennium Trees are alive with magic energy syphoned from the ley line nexus which makes them living mega-damage structures and P.P.E. batteries of **unparalleled** magnitude. This energy flows throughout the tree and is housed in its appendages, bark and leaves, which is why they can be turned into magic items.

The prayers of priests and the cries of the needy have seemingly caused leaves, twigs and bark to fall from the tree without ill effect. In fact, a twig that falls at the feet of the needy is likely to be a magic wand of considerable power and a tremendous honor (in fact, about 25% will return the magic wand or staff to the tree when they are done with it so as to not be too presumptuous or greedy). However, to *deliberately break* a branch, twig or leaf from the Tree of Life will cause a mega-damage explosion of energy and evoke the wrath of faeries, monks, priests and other "friends" and protectors that live in or near the tree.

Forcibly removing any part of the tree, no matter how small, or inflicting more than 15 points of M.D. will cause a mega-damage explosion that covers a sizable area. It is interesting to note that an equivalent amount of damage caused by *accident* seldom results in a damaging eruption of energy, and a twig, branch, leaf or bark *given up* by the tree has no ill effect whatsoever —**further**evidence of the tree's awareness.

**The damage caused by the energy eruption when the following is removed:**

Leaf: 2D4x10 M.D. to a 10 foot (3.0 m) area around the leaf when a leaf is hurt or severed at the stem.

Twig (wand size): 3D6x10 M.D. to a 50 foot (15.2 m) area around the damaged twig.

Small to Medium Branch (staff size): 2D4x100 M.D. to a 200 foot (61 m) area around the damaged branch.

Large Branch: 4D4x100 to a 500 foot (152 m) area around the branch.

Giant Branch: 2D4x1000 M.D. to a 1000 foot (305 m) area around the damaged branch.

Minor damage to the Trunk/Bark: 2D4x100 M.D. to a 200 foot (61 m) area around the damaged part.

Serious damage to Trunk/Main Body: A ley line storm will suddenly appear out of nowhere whenever the tree trunk, roots, major limbs and/or main body are under siege. See the ley line storm description for full details.

**Note:** The mega-damage caused from an energy eruption or ley line storm does NOT inflict additional damage to the tree.

## Protectors & Inhabitants

A second means of defense is provided from the many beings that live in and around the tree. Typically, Millennium Trees are the home to a variety of intelligent beings, animals, and insects. For example, in England, the average tree will have a population of humans, D-Bees, faerie folk **and/or** other supernatural beings. The Kyoto Tree of Life is in the center of the greatest city in the New Empire, populated by warrior monks, priests, sorcerers, and samurai among a general population of over a million.

All of these inhabitants, weak and powerful, human and super-human, live in harmony with the tree and the other inhabitants. They will unite and fight to protect the Sacred Tree, just as the Millennium Tree responds to their needs. The perfect symbiotic relationship.

## Millennium Ley Line Storms

The typical ley line storm is similar to a modern-day electrical storm that travels up and down ley lines. The skies turn a dark green-grey color, with dark grey to black rolling clouds, booming thunder and winds gusting at 35 mph (56 km). A chill fills the air and bluish-white bolts of **electrical** energy shoot down from the sky. Everything in the area of the storm crackles with a halo of energy. Although the storms are compared to conventional rainstorms, there is seldom any rain. A typical ley line storm will last 3D6x10 minutes, while the worst last twice as long and usually occur at the nexus point.

Faerie folk, oni and practitioners of magic usually flee at the first hints of these storms, because they always have a strange effect on men and creatures of magic. Normally, a ley line storm can occur at anytime along any ley line, on land or at sea. **The Millennium Trees** seem to control and abate the energy surges suspected of causing *random* ley line storms. A random storm seldom appears on any of the ley lines connected to the nexus point where a Tree of Life is located. However, the tree can instantly create and direct a ley line storm as a means to protect itself! These storms are called Millennium Storms and are usually created to frighten, defend against, or attack an invading army, **oni/demons**, men of magic and supernatural beings that are threatening or attacking the tree or its inhabitants.

Millennium storms are always of incredible magnitude and can last up to ten hours. Storms that rage for nine or ten hour temporarily exhaust the great tree and there must be a two hour period of calm before a new storm can be created. Otherwise, the tree can create Millennium storms for short periods of time as often as desired. To illustrate the tree's unfathomable power, it can also create several storms simultaneously and send one down *each* of its connecting ley lines, as well as maintain the largest at the nexus point where the tree is located. The intensity and location of each storm can be controlled with pinpoint accuracy.

**Note:** The details about ley line storms can be found in *Rifts Atlantis* and *Rifts Underseas*, while information about ley lines and Millennium storms can be found in *Rifts England*. Consequently, we are not going to reprint them again here. However, for easy game use and reference, the various "**gifts**" of the Millennium Tree are being reprinted in the following pages.



# Powers of the Millennium Tree & “Gifts” of Magic

**Note:** What follows is a list of the tree's most notable magic powers and some magic items offered by Millennium Trees as "gifts." The Millennium Tree at Kyoto may give of itself to trusted friends, renowned champions of good, Shinto priests, **yamabushi** and monks.

## Bark Body Armor

The bark can be glued or bolted to an undergarment and used to create lightweight, mega-damage body armor.

- Typically a full suit offers 120 M.D.C.
- Weighs only 15 pounds (6.75 kg)
- Good mobility, -5% prowl penalty.
- Magic Properties: Contains 4D6 P.P.E. points which can be drawn upon by practitioners of magic. Magic energy attacks, including fire, dragon's fire, lightning and energy blasts, inflict one-third normal damage. Blows from rune weapons and most other magic weapons inflict full damage. Blasts from conventional energy weapons and explosives also do full damage.
- Bonuses: +1 to save vs poisons, toxins, gases and disease.
- Cost: Varies dramatically. Most people won't sell the armor because it was a gift from the Tree of Life. Those who are selling the armor are likely to be stolen or murdered to get it or bought it from somebody who did. In such instances, the armor can cost 80,000 to 100,000 credits. Rare except among warrior monks and Shinto priests.

## Bark Shield

A mega-damage shield can also be made from the bark of a Millennium Tree. The shield can be used to parry mega-damage rune weapons, other types of magic weapons, hand to hand attacks from vampires and supernatural beings, dragon's breath and similar slow moving or predictable weapons and attacks. The shield user rolls to parry as usual. A successful parry means the shield blocked the attack and absorbs the damage. **Note:** Normal M.D.C. shields weigh twice as much, but cost between 1000 and 4000 credits.

M.D.C. by Shield Size: Small: 60 M.D.C. and weighs 3 pounds (1.35 kg), Medium: 90 M.D.C. and weighs six pounds (2.7 kg), Large (covers three-quarters of the body): 120 M.D.C. and weighs 12 pounds (5.4 kg) but is -1 to parry due to its awkward size.

Cost: Varies dramatically. Most people won't sell the shield because the bark was a gift from the Tree of Life. In instances of a sale, the shield usually costs 15,000 to 30,000 credits. Rare except among warrior monks and Shinto priests.

## Camouflage

If the tree desires to do so, it can create the equivalent of the chameleon spell on living creatures, human or animal, that are hiding among its leaves and branches or against its trunk. Literally thousands of inhabitants can be cloaked in this manner. Exactly who is affected by the magic is completely up to the tree, who can conceal everyone or leave out specific characters. The magic is identical to the spell except that the duration lasts as long as the tree believes necessary and stops protecting anybody who leaves the tree.

## Control over Ley Lines, Storms & Rifts

The Millennium Tree prevents the manifestation of random ley line storms and can create and control a massive ley line **storm(s)**. This connection and control of the nexus and ley line energies also means that the tree feels when the energy is being siphoned by others for the use of

magic or to open a dimensional Rift. **Note:** This is one of the powers used quite frequently by the tree.

Just as the tree prevents random ley line storms, it also prevents the random opening of dimensional Rifts. If a Rift is deliberately opened on one of its ley lines or connecting nexus, the Great Tree can close it within 2D4 minutes. Likewise, the Millennium Tree can open a Rift at will; however, the tree does not understand dimensional travel and must have a practitioner of magic to help open a Rift to a specific dimension, otherwise it is completely random. **Note:** Also see ley line **teleportation**.

## Control over Normal Weather

The tree also has limited control of the weather around it. Control is limited to a ten mile radius around the tree with the following results. Create/summon fog for up to eight hours, create/summon a light rain for 1D4 hours, dispel a light rain, change wind direction, the intensity of storms is always half, and floods and earthquakes never occur. **Note:** This is one of the powers used quite frequently by the tree.

## Leaf: Blanket of Healing

The tree's leaves are as giant as the tree itself, typically four to six feet (1.2 to 1.8 m) in length and can be used as lightweight body armor or as a blanket of healing. The Tree may give a leaf or two to trusted friends, priests, monks and renowned champions of good.

### Healing Properties:

- Instantly negates poison, toxins and other chemicals.
- Heal wounds, restoring 2D6 S.D.C. and 2D6 hit points or 2D6 M.D.C. in the case of mega-damage creatures.
- Adds +30% to characters trying to recover from a coma when the blanket is laid over the person and left on him.
- Camouflage the sick or injured — same as the chameleon spell and lasts as long as the character does not take any aggressive action or move from one spot.
- Restoration: This power is the same as the tree's and can be used to restore severed limbs and bring comatose characters back to consciousness and healed up with two hit points. However, the use of this power completely destroys the **leaf** — it withers and disappears.
- Cost: These incredible leaves have been known to garner 90,000 to 150,000 credits. Rare even among warrior monks, yamabushi and Shinto priests.

## Leaf Body Armor

Large leaves from the giant Millennium Tree can be cut in the center and placed over the body like a mega-damage Mexican poncho or worn as a mega-damage cloak or under a robe. An alternative is to tuck and fashion one or two leaves into a more stylish suit of armor. Of course, a mega-damage knife, scalpel or laser is necessary to cut or make holes. Most leaf suits are pretty simple coverings and can be worn over more conventional suits of body armor. The leaf retains its soft, flexible nature for generations until it is destroyed.

- Typically 60 M.D.C., because leaves provided by a Millennium Tree as armor are usually the largest leaves and offer the highest degree of M.D.C.
- Weight 5 pounds (2.25 kg)
- Excellent mobility, no encumbrance.
- Magic Properties: The leaf has 4D6 P.P.E. points which can be drawn upon by practitioners of magic, and magic energy attacks inflict one-third normal damage.
- Bonuses for the wearer: +2 to save vs poisons, toxins, gases and disease.



- **Cost:** Varies dramatically. Most people won't sell the armor because it was a gift from the Tree of Life. When it is sold, the armor can cost 50,000 to 100,000 credits. Rare, except among warrior monks, yamabushi and Shinto priests; common among the members of these clergy.

## Ley Line Teleportation

The tree can **teleport** any number of people, vehicles and equipment to any point along any of its connecting ley lines!

On occasion, it may "pop" people in trouble to a different locale, or send an enemy miles away.

## Power to Heal

The Tree of Life can magically and instantly heal the sick and injured as follows. Up to 50 S.D.C. and 50 hit points (or 50 M.D.C. for mega-damage creatures) every few minutes. As many as a hundred people can be healed in a single instant, but such mass healing is uncommon.

The tree can also cure sickness and disease. Physical pain, burns and discomfort are reduced by half when under the shade of the tree or embraced in one of its branches, plus normal healing is increased by two fold. Characters in a coma are +30% to save vs death. The tree cannot eliminate insanity or addiction, although a period of treatment (weeks) while under the tree will add +10% to the success of recovery. **Note:** The powers of healing are provided frequently by the tree.

## Purify Food & Water

This power is identical to the magic spell except that the tree can affect 100 times more than a first level wizard with a single spell.

## Resurrection & Restoration

If a person has recently suffered from dismemberment, less than 12 hours, and his/her body is brought to the tree with the severed limb(s), the tree can magically reattach the appendage(s) and restore the person to health without scarring.

Likewise, the recently deceased, less than 4 hours, can be brought back to life, provided the body is mostly intact. Both incredible feats of healing draw on the magic and life force of the tree. Thus, when a restoration is performed, a small branch near the person being healed withers away and disappears. When a resurrection is performed, one of its large limbs will wither and disappear. **Note:** Resurrection, restoration and other feats of powerful magic are not everyday occurrences and are not available at the drop of a hat. The intervention of a priest, monk or well respected friend is likely to be required.

## Sixth Sense Warning

The entire tree is alive and aware, thus it knows everything that is happening in, on, and around its gigantic body. **Consequently**, it is seldom caught unawares and can warn its friends, inhabitants and visitors of impending danger. This power manifests itself in a way similar to the psionic power of sixth sense.

The recipient of the magical warning will suddenly, as if by reflex or coincidence, look in a particular direction to see an approaching enemy or danger; or suddenly duck or move out of the way (+10 to dodge); or just feel that something is wrong, making him alert for trouble (+3 on initiative); or the sudden need to go check on friends or family. **Note:** The danger must be within the tree's range of perception which includes everywhere on its body and within 500 feet (152 m) from its farthest branch. Noisy troops, noisy vehicles, and explosions can be heard/felt by the tree up to a mile (1.6 km) away. Smoke and the scent of fire can be detected 20 miles (32 km) away. This is one of the powers used quite frequently.

## Visions and Dreams

Although the Tree of Life is not a powerful psionic, its reputation as a place of peace and inspiration brings people from throughout the islands and even occasional visitors from China and Indonesia to meditate under its leaves. Often the focus of thought combined with peace of mind will help people to gain personal insight to themselves or about their problems without any intervention by the tree. However, the tree can magically perform an oracle spell on a specific person, enabling him to glimpse the possible future or perform clairvoyance. It can also magically send a vision which is not a glimpse of the future, but typically serves as inspiration to encourage good deeds, provide information, or warn of trouble brewing; remember, the tree hears and knows many things. **Note:** This power is used quite frequently by the tree to help priests, monks, samurai and good friends.

---

# Millennium Tree Magic Wands & Staves

---

Finding the branch or leaf from a Millennium Tree is rare and valuable. Each twig contains a certain amount of P.P.E., like a living battery. The twig remains alive and can be used to create magic wands or as a talisman that contains a small amount of P.P.E. which can be used by priests, monks, and practitioners of magic. The twig replenishes any used up P.P.E. by drawing on ambient magic energy; takes about 24 hours to recharge.

All "true" wands created by the tree will automatically have specific powers that cannot be changed, except by extremely powerful alchemists and bio-wizards. To change the powers is to corrupt the "gift" of the tree. *Corrupted wands and staves* are the product of outside or evil intervention and have different powers than the ones provided by the tree.

All "true" wands and staves are sacred to Shinto priests, yamabushi and sohei monks. They are also coveted by many others. Just before a member of the clergy dies, his or her magic items are either passed on to one of his children or a deserving associate, typically a young priest or monk, or worthy warrior. If no such person exists, the item goes back to the religious order, usually the character's founding temple.

## Millennium Wands

### Features common to all Wands and Staves

1. A typical twig/wand is one to three feet (0.3 to 0.9 m) long. A typical branch/staff is four to eight feet (1.2 to 2.4 m) long.

2. Wand: 1D4×100 M.D.C.; Staff: 2D4×100 M.D.C.; any damage suffered by the item is healed within 24 hours.

3. Wand: 1D4×10 P.P.E.; Staff: 2D4×10 P.P.E. This energy reserve can be temporarily syphoned by its owner or other creatures of a good alignment provided they have the permission to do so from the wand's owner, and the user's intentions are to help others (never for purposes of greed or revenge). The twig must be in the user's possession in order to draw on its additional energy.

4. Wand: Damage as a weapon is 1D4 S.D.C., but does M.D. damage against vampires.

Staff: Damage as a weapon is 2D6 S.D.C., unless otherwise stated, but does 2D6 M.D. damage against vampires and most supernatural beings. In some cases, weapons made from the Millennium Tree do double damage.

5. The staff or wand regenerates *all* lost M.D.C. and P.P.E. after a 24 hour period has elapsed, unless it has been completely destroyed (all M.D.C. is lost), in which case it completely disappears.



6. Powers and bonuses given to the wielder of a Millennium Tree wand or staff remain constant only while the character has the magic item in his possession. If he loses the item, he loses all the abilities and bonuses associated with it.

7. Often the powers of the **twig/branch** reflect the reason it was given (or taken).

8. When a wand is given back to the Millennium Tree, the stick is pressed into the tree (a task that should be difficult but happens with minimal effort) where it turns back into a living part of the tree.

9. Shinto priests, **yamabushi**, sohei monks (and in the west, Millennium Druids) will instantly recognize all true wands and staves. They also try to acquire corrupted wands and staves to return them to the himorogi.

Note: The costs of wands and staves vary dramatically. Most people won't sell the items because they were a rare gift from the Tree of Life. When it is sold, a wand can cost 100,000 to 200,000 credits, while a staff 250,000 to 500,000 credits. Rare, except among warrior monks, yamabushi and Shinto priests. Staves are especially common among the members of these clergy. Wands are extremely rare for everybody. The weapons and armor from the Millennium Tree are especially rare in places away from the New Empire and extremely rare on the mainland.

## Wand of The Animal

Possesses the usual features plus the following:

- The constant power granted to its owner is climb at a proficiency of 90%/75%.
- Spell Magic: A total of five spells, (any combination or repetition) can be cast per 24 hour period. Spells available include: eyes of the Wolf, swim as a fish (superior), superhuman strength and metamorphosis: animal. Spell strength is equal to a 7th level sorcerer.

## Wand of Deception

A short, thin, scraggly stick that looks like an ordinary, leafless twig. Possesses the usual features plus the following:

- The constant power granted to its owner is chameleon. Others holding on to the wand will also enjoy the chameleon power until they let go.
- Spell Magic: A total of five spells (any combination or repetition) can be cast per 24 hours. Spells available include: death trance, fool's gold, multiple image, mask of deceit, and turn invisible (self). Spell strength is equal to a 7th level sorcerer.

## Wand of Divination

A narrow, straight stick with one end being a bit more narrow and pointed than the other. The dull tip of the pointed end is placed on the flattened palm of its owner where it stands straight up and is spun, like a top, in a clockwise circle to activate its magic.

The magic divination power: The stick will answer basic questions in the following manner: **Yes** answers will always cause the stick to stop spinning and fall to the right. A no answer means the stick falls to the left. **Uncertain** means the stick will fall pointing at a twelve o'clock position. **Probably** will see the stick fall to the six-thirty position. **Danger to the land**, including invasion, mass destruction, and plague, will cause the stick not to fall at all but to stop spinning and stand straight up, balanced on the character's palm! Serious danger or destruction to the Millennium Tree from which the magic wand was acquired will cause the stick to turn black.

The stick really only answers important questions about danger, death, and helping others. Answers to silly or petty questions are pure coincidence.

Typical questions are as follows:

- Is there danger or trouble (coming, imminent, here, etc.)?
- Does this danger have a face? Referring to danger caused by a person rather than a natural disaster. However, the identity is not revealed, except for asking a series of questions like, do I know this face? Is he human? Is it "so and so?"
- Will **I/we** recognize the danger (or valuable/good fortune) when I/we see it?
- Is the danger unavoidable? Or is there a chance the trouble/sorrow/danger will pass us by or end soon?
- Will there be death? Will many people die?
- Will **I/we** die? (The answer is usually uncertainty).
- Will we succeed/win? (The answer is usually uncertainty).
- Will the danger threaten the land? Usually referring to the people or location of a specific kingdom or geographic area.
- Can we make a difference? Can our actions help? Typically, the answer is yes.
- Will this venture bring us great reward? The response to this broad question is probably yes, interpreting satisfaction at helping others as a great reward. A more specific question about fame, glory, or financial reward is likely to garner a response of uncertainty or probably.
- Will somebody live/recover? (The answer is often uncertainty).
- Will I find peace or love? (The answer is typically uncertainty).

## Wand of Dowsing

This is a "Y" shaped stick that is held at the two ends of the "Y."

The magic dowsing power: The stick vibrates and points in the direction of the object, person, substance desired by the dowser. When the exact location is found, the stick vibrates faster and more noticeably, finally pinpointing the exact location and then stops vibrating, pointing downward. Possesses the usual features plus the following:

- The constant power granted to its owner is the ability to correctly sense the direction he or she is traveling (98%) and the approximate time of day (80%). Adds a bonus of +5% to tracking and wilderness survival skills when applicable.
- Magic powers are different than most wands. The divining or dowsing rod can be used to sense the direction and location of the following: Water, coal, ley lines or nexuses, the nearest Millennium Tree, home or a loved one (not just a casual friend or acquaintance, nor an enemy).

Dowsing can be performed a total of five times per 24 hours. The vibrating and pointing of the divining rod lasts until the object of the dowsing is located or until the dowser's concentration is broken or interrupted. A dowsing can last a few minutes or several hours, up to a maximum of three hours at a time. If interrupted, the dowsing can be begun a new, but counts as a new dowsing. Range is limited to 300 miles (482 km). If the desired object of the dowsing is farther than that, the wand vibrates for a moment and then stops. No direction is given.

## Wand of Knowledge

A gnarled stick with two buds at the tip. Possesses the usual features plus the following:

- The constant power granted to its owner is tongues. Others holding on to the wand will also enjoy the same power until they let go.
- Spell Magic: A total of five spells can be cast per 24 hour period. Spells available include: eyes of **Thoth**, words of truth, memory **bank**, and commune with spirits. Spell strength is equal to a 7th level sorcerer.

## Wand of Life

The wand looks like an ordinary twig, seldom larger than 12 inches (0.3 m) in length, and has 2D4 leaf buds. The buds never die or drop off and never grow to full-size leaves. The number of buds indicates how often the wand can be used to heal and how many times its other spells can be cast in a 24 hour day. Possesses the usual features plus the following:

- One power is superior healing: 1D6 hit points or S.D.C. points are restored per each bud and the mystic healing is instant and leaves no scars. The owner is also +2 to save vs poisons, drugs, toxins, and disease, and +5% to save vs coma.
- Spell Magic: The total number of spells one can cast per 24 hours is equal to the number of buds (2 to 8). Spells available include: negate poisons, cure minor disorders, cure illness, purification of food and water and water to wine. Spell strength is equal to a 7th level sorcerer.

## Wand of Power

The wand is a long (two to three feet/0.6 to 0.9 m), leafless stick with a sharp point and jagged in shape, vaguely resembling a lightning bolt. Possesses the usual features plus the following:

- The constant power granted to its owner is invulnerability. Others holding on to the wand will also enjoy the same invulnerability until they let go.
- Spell Magic: A total of five spells, (any combination or repetition) can be cast per 24 hour period. Spells available include: energy disruption, call lightning, armor of **Ithan**, superhuman strength, and negate magic. Spell strength is equal to a 7th level sorcerer. Extremely rare.

## Wand of Seeing

The wand is a leafless, long (two to three feet/0.6 to 0.9 m), perfectly straight stick except for two natural **protrusions/knots** that vaguely resemble a pair of eyes. Possesses the usual features plus the following:

- The constant power given to its owner is to see the invisible and a bonus of +5% to track and +5% to identify plants. Others holding on to the wand will also see the invisible.
- Spell Magic: A total of five spells (any combination or repetition) can be cast per 24 hour period. Spells available include: globe of daylight, see aura, detect concealment, eyes of **Thoth**, and the eyes of the wolf. Spell strength is equal to a 7th level sorcerer. Extremely rare.

## Weapons of Wood

There are two types of sticks created by the tree specifically as hand to hand weapons.

The **vampire slaying javelin** inflicts the typical 1D6 S.D.C. against most creatures, but inflicts 4D6 M.D. against supernatural beings and 6D6 M.D. against vampires and all forms of undead, animated dead, zombies, mummies and **maxpary shamblers**. The accurate range of a normal javelin is about 300 feet (91 m) but the magic javelin can be thrown accurately up to 700 feet (213 m) and magically returns, flying back to the hand of its owner. The return trip takes about three seconds and counts as one melee **action/attack**. The javelin looks like a crude, handmade, wooden weapon of inferior quality.

The **throwing stick** is a short, flat stick, sometimes with a rounded end, traditionally used for hunting and defense. The most famous throwing stick is the boomerang, but Africans and people of the South Pacific have used a variety of wood, stone and iron throwing sticks for thousands of years.

The magic throwing stick inflicts 1D6 S.D.C. against mortal creatures but does 3D6 M.D. against supernatural beings and 4D6 M.D. against vampires. 200 feet (61.0 m) is the range of a normal throwing stick, but this magic stick can be thrown 400 feet (122 m) and magically flies back into the hand of its owner, just like the magic javelin.

---

## Millennium Tree Staves

---

### Sohei Staff of Defense

The Sohei Staff is a simple eight foot (2.4 m) long shaft of wood used as a walking stick, the symbol of the sohei order of monks and as a weapon. This is the simplest, least power staff provided to anybody from the Sacred Tree. The sohei believe that men must learn to fend for themselves, and ask only for a simple weapon with which they can protect themselves and others from evil. Monks of 9th level or higher experience, or great warrior monks may have one of the other types of staves.

- Constant power: none, other than a sense of humility and self reliance.
- It has 2D4x100 M.D.C., regenerates all lost M.D.C. within 24 hours and possesses 2D4x10 P.P.E. that can be syphoned and used by its owner.
- It inflicts 2D6 S.D.C. against mortal opponents or 3D6 M.D. against supernatural beings. The weapon is so attuned to the monk who owns it that its power increases with the character's level of experience. Add 1D6 M.D. at levels 5, 10 and 15.

### Staff of the Earth

The staff is a comparatively short, thick stick that's dark brown in color. It possesses the usual features plus the following:

- The constant powers granted to its owner are the abilities to sense magic and ley line, similar to the ley line walker.
- Spell Magic: A total of ten spells (any combination or repetition) can be cast per 24 hour period. Spells available include: chameleon, ignite fire, purify food/water, superhuman strength, repel animals, stone to flesh, turn dead, exorcism and circle of protection (simple). Spell strength is equal to a 10th level sorcerer.

### Staff of the Hunter

This is a tall, thin staff with a bulbous top like a club. It possesses the usual features plus the following.

- The constant powers granted to its owner are the abilities to identify tracks, track humanoids, track animals, prepare animal hides, land navigation, and wilderness survival at 88% proficiency.
- Spell Magic: A total of eight spells (any combination or repetition) can be cast per 24 hour period. Spells available include: ignite fire, climb, escape, swim as a fish, befuddle and magic net. Spell strength is equal to a 10th level sorcerer.
- As a weapon, the staff does 2D6 S.D.C. damage against mortal foes and 2D6 M.D. against mega-damage monsters and oni. Quite rare except among **yamabushi**.

### Staff of Life

The staff looks like a giant version of the wand: an ordinary branch, six to eight feet tall (1.8 to 2.4 m), with 2D4+6 leaf buds. The buds never die or drop off and never grow to full-size leaves. The number of buds indicates how often the staff can be used to heal and how many times its other spells can be cast in a 24 hour day.

It possesses the usual features plus the following:

- The owner of the staff is +2 to save vs poisons, drugs, toxins, and disease, and +5% to save vs coma. He can perform superior healing once a day per each leaf bud, so if there are ten buds, the healing can be performed ten times a day. The restoring of 1D6 hit points and/or S.D.C. points per each bud — ten buds means 1D6x10 points are restored. As usual, the mystic healing is instant and leaves no scars.
- Additional Spell Magic: The total number of spells one can cast per 24 hours is equal to the number of buds (8 to 14). Spells available include: Globe of daylight, breathe without air, negate poisons, cure minor disorders, cure illness, purification of food/water, and water to wine. Spell strength is equal to a 10th level sorcerer.
- Restoration: This power is the same as the tree's and can be used to restore severed limbs and bring comatose characters back to consciousness and healed up with two hit points. However, the use of this power Permanently destroys four of the leaf buds (they wither and disappear). When all the buds are gone, the staff disappears. Quite rare except among the shinto priests.

## Staff of Prosperity

This is a long, slender rod of golden color, covered with a coiling vine and leaves. The staff possesses the usual features plus the following:

- The constant powers granted to its owner are the abilities to identify fruits and plants and accurately identify ingredients (including poison) in foods by taste, as well as +4 to save vs poison and +10% bonus to cooking skill.
- The magic powers of this powerful rod are different than most. When stuck in the ground, it transforms the surrounding land into rich, fertile soil (doesn't work on sand or solid rock). This area of enchanted land never suffers from blight, disease or minor frost. Even invasions by locusts, major insect infestations or severe frost never destroys more than 25% of the crops. Crops grown in this soil yield twice as much as normal and produce some of the biggest and best fruit and/or vegetables anyone can remember.

If the staff is used as the main vertical support strut to make a scarecrow (and to conceal the mystic staff) — problems with birds and other pests are reduced to less than 10%.

The magic affects a 20,000 square foot area plus an additional 2000 square feet ever year for the next twenty years. At the end of 20 years, the area of enchantment stops spreading. Removing the staff will return the land to its normal condition. Very rare except in the New Empire.

## Staff of Purity

This staff is a smooth, white colored wood that is typically tall and slender with one end being a bit more narrow than the other. Possesses the usual features plus the following:

- The powers granted to its owner are the abilities to purify water and swim and fish (using the staff as the pole) at 88% efficiency. The character will never drown while holding onto the rod.
- Its magic powers are similar to the staff of prosperity, only this enchantment affects water.

When thrown into a well of water or buried under rocks in a spring or small stream, the water never becomes polluted regardless of the type or amounts of pollutants (turns clean if already polluted) and stays free of future pollution, poison and disease. Moreover, the enchanted water cannot be affected by magic such as curses, spoil or turn water to wine, unless the water is drawn (removed) from the well, spring or stream. The water always tastes cool, fresh and delicious.

- As a weapon, it only inflicts the usual 2D6 S.D.C. against mortal creatures, but inflicts 4D6 M.D. against supernatural demons/devils and 6D6 M.D. to vampires!

## Staff of the Serpent

This staff is a branch that is gnarled and twisted in such a way that it resembles the coils of a snake. This is one of the few Millennium Staves that is offensive in nature. It possesses the usual features plus the following:

- The constant powers given to the staff wielder are the ability to see the invisible and it makes him invulnerable to all snake venoms, dragon's fire and all types of dragon's breath, from gas to acid, plus all types of mega-damage fire.
- The other powers of the staff are that it inflicts 6D6 M.D. to dragons and similar supernatural serpents (3D6 M.D. to all others), and can turn into a mega-damage snake when thrown to the ground and commanded to **metamorph** by its owner. The magic snake has a horror factor of 10, four attacks per melee, inflicts 2D6 M.D. per bite (4D6 to dragons), has a P.S. of 10, can see the invisible and can endure 150 M.D.C. before it turns back into a wooden staff.

The snake is ideal for protecting its owner's back, alerting him to danger and helping to fight enemies. It can also be given simple commands, like a trained dog, to hide or retrieve keys, weapons, people, etc., however the snake cannot travel more than 1000 feet (305 m) away from its owner or it automatically turns back into the staff. Otherwise, the staff can remain a snake as long as its owner desires. Quite rare except among bishamon monks.

## Staff of the Wind

A staff with an oval shaped hole at the top and long, vine-like strands that constantly seem to be blowing in the wind even when there is no wind. It possesses the usual features plus the following.

- The constant power are granted to its owner float in air and the ability to sense wind direction. Others holding on to the staff can float in the air with the owner until they let go.
- Spell Magic: A total of ten spells (any combination or repetition) can be cast per 24 hours. Spells available include: levitation, fuel flame, fly as the eagle, fingers of wind, call lightning, wind rush, summon fog and calm storms. Spell strength is equal to a 10th level sorcerer.

---

# Corrupted Wands & Staves

---

Powerful alchemists and bio-wizards (usually of an evil or anarchist alignment) can alter or "corrupt" an existing wand or staff by purging it of its existing powers and replacing them with new and different ones. Similarly, they can forcibly take twigs and branches from Millennium Trees and create magic items from them. Most of the magic wands or staves on Earth are made of wood from these mystic trees.

In all cases, corrupted wands and staves are not quite as powerful as those given freely by the tree. All possess the same basic features unless otherwise stated, but have the following limitations:

1. The number of spells available for a corrupted wand is limited to a maximum of four low level spells from levels one through six, or two high level spells from levels seven through twelve, or a combination of one high level spell and two low level spells. Magic incantations from levels 13 to 15 cannot be instilled in a magic rod.

The number of spells available for a corrupted magic staff is limited to a maximum of eight low level spells from levels one through six, or four high level spells from levels seven through twelve, or a combination of two high level spells and four low level spells. Magic incantations from levels 13 to 15 cannot be instilled in a magic rod. Also see number five for the exchange of low level spells for increased mega-damage.

2. The equivalent level of spell strength usually ranges from third to fifth level for wands and fourth to seventh level for staves. However, truly powerful alchemists and bio-wizards can increase the power by an additional two levels of spell strength.

3. The number of times the available spells can be cast varies. If a corrupted wand has only one spell it can be cast six times per 24 hour period. Two spells means three times each, three means two times each, while wands with the entire range of four typically means that the spells can be selected and used as desired, in any combination or repetition, for a maximum of six times (that's a total number of six spells per 24 hours).

The situation is similar for a magic staff. If a corrupted staff has only two spells, they can be cast four times each per 24 hour period. Three spells two times each, four spells two times each, five to eight spells means that the spells can be selected and used as desired, in any combination or repetition, for a maximum of eight times (that's a total of eight spells per 24 hours).

4. The so-called "constant" or additional powers or abilities provided from *true* Millennium wands and staves are not an available feature.

5. Damage inflicted by a wand as a weapon is unchanged, 1D4 S.D.C. (1D4 M.D. to vampires).

Damage inflicted by a corrupted staff is a different story. Most corrupted staves are designed as weapons of evil and therefore usually have combat capabilities, not only in the type of spells available, but as a weapon in hand to hand combat. The typical corrupted staff inflicts 3D6 M.D. and double damage to vampires. An additional 2D6 M.D. can be added at the expense of one low level spell. This means the maker of the staff could exchange one magic spell to inflict 5D6 M.D., or two magic spells to inflict 7D6 M.D. or four low level magic spells for a maximum damage of 1D6×10M.D.!

6. Bio-wizards in particular, may use the wooden shafts and their stored P.P.E. to supplement the power of other magic devices. The magic stick may be the handle and true source of magic for a scepter, cane, spear, club or mace, or even built into or concealed in a helmet, crown, armor, box, or other enchanted object. These magic items will have the same range of spell casting powers as a corrupted wand or staff. If a Millennium wand is corrupted to be part of a weapon, the weapon can inflict 1D6 M.D. at the cost of one low level spell, similar to the corrupted staff; up to a maximum of 4D6 mega-damage.

---

# Enchanted Items

By C.J. Carella

---

The following items are a handful of magic weapons and equipment that can be acquired by adventurers, warriors and priests in Japan.

---

## Magic Weapons

---

### Elemental Shuriken

These weapons are favored by ninjas and adventuring martial artists — when they can find these rare magic items. These magical weapons typically come in sets of five, and can be found in the lands of the New Empire, The Zone, the Freelands and China, but are very rare and expensive. Human alchemists and the occasional tengu or dragon manufacturer them. The five **shurikens** represent the five Japanese elements (in addition to the traditional earth, air, water and fire, Japanese alchemists considered wood to be a separate element). The **shuriken** strikes, and then flies back to the wielder. Each of these enchanted weapons has a separate power, damage and range, all related to their element:

**Air Shuriken:** Inflicts 2D6 M.D., plus, three times per day, it can produce a lightning strike when it hits a target, inflicting 1D4×10M.D. (+3 to strike; the bolt comes from the shuriken while it is held by the wielder and pointed at its target). **Range:** 1,000 feet (305 m) for the thrown shuriken, 2,000 feet (610 m) for the lightning bolt.

**Fire Shuriken:** Inflicts 3D6 M.D., plus it can shoot fire balls four times a day. The fire balls inflict 5D6 M.D. and are +3 to strike; the flame balls shoot from the shuriken, which must be held by the wielder and pointed at the desired target. **Range:** 600 feet (183 m) for the shuriken, 1,000 feet (305 m) for the fire balls.

**Water Shuriken:** Inflicts 3D4 M.D., and can cast each of the following spells two times a day: calm storms, heal wounds, and negate poisons/toxins. **Range:** 1,000 feet (305 m) thrown in the air, but it can also be thrown underwater where it rockets up to 2000 feet (610 m)! The spells have their usual limit as per the spell.

**Earth Shuriken:** Inflicts 4D6 M.D., and can cast the invulnerability spell on the wielder three times per day, at 6th level of power. **Range:** self.

**Wood Shuriken:** Inflicts 2D4 M.D. (triple against vampires and creatures who are affected by wood). Once per day, the shuriken can summon an earth-tree elemental (tree-shaped), with 200 M.D.C., +2 to strike, parry and dodge, and inflicts 3D6 M.D. with a punch. Once summoned, the elemental will fight for the shuriken wielder for 1D6 minutes. **Range:** 1000 feet (305 m) when thrown.

**Cost:** A set of five can cost anywhere from 700,000 to a million credits; very rare. Individual shurikens (a broken set) sell for around 180,000 to 220,000 each; very rare.

### TW Power Shuriken

A common Chinese **techno-wizard** item, enchanted with a magical static charge that is released on impact. The shuriken inflicts 2D4+4 M.D.C. electrical damage on impact. The charge is good for only one attack; the shuriken becomes a common S.D.C. weapon afterwards. Techno-Ninjas favor these weapons. **Cost:** 500 credits each.

### TW Fire-Breathing Arquebus

When the first European travelers arrived in Japan, they brought muskets and arquebuses (bell-shaped, short-range shotguns), which greatly impressed the islanders. Japan was manufacturing copies of those weapons in a matter of years.

Japanese alchemists, eta **techno-wizards** and tech-ninja became fascinated with the concept of firearms. They tried to replicate the effect using magic, and succeeded in creating an equivalent weapon by binding fire elementals to metal replicas of the European weapons; this may have been one of the first techno-wizard weapons ever created! During the Great Cataclysm, these weapons became powerful mega-damage "guns" and were used by the desperate survivors who eventually formed some of the low-tech shogunates and kingdoms of Japan. They are especially popular among the eta of the Freelands.

They look like ancient matchlock muskets or bell-barreled arquebuses. Their fire blasts are accompanied by the stench of brimstone, and inflict 5D6 M.D. (Range: 800 feet/244 m). The weapon's energy is inexhaustible; it can fire as long as magic energy exists on Earth. Rate of fire is limited to three shots per melee round. **Cost:** These weapons are rarely for sale (passed on from one generation to another), and when they are, they cost upwards of 200,000 credits!

## Magic Powder Grenades

These enchanted items are given to the greatest assassins of Ninja Clans, usually of *chunin* rank or higher (see the Mystic Ninja O.C.C.). Tech-ninja also like to get their hands on these rare items. They are based on the traditional eggshell bombs, but the powders used are magically enhanced for a number of purposes. The most common magic powder grenades include:

**Blinding Grenades:** This magical grenade strikes the target and blinds (save vs ritual magic to resist; 16 or higher) for 1D6 minutes. Affects everybody in a 10 foot (3 m) diameter. The victims are at -6 to strike, parry and dodge during that period. **Cost:** 500 credits each.

**Grenades of Confusion:** When it explodes, wisps of confusion (as per the spell) emanate from the grenade, enveloping 1-8 people in the area. A save vs ritual magic is needed to resist the spell; same basic features as the spell equal to 4th level. **Cost:** 3000 credits each.

**Minor Curse:** As per the spell equal to 4th level; people in a 20 foot (6 m) area will be struck by the curse unless they make saving throws versus ritual magic. There is one grenade for each type of curse. **Cost:** 6000 credits per each grenade.

**Magic Net:** When the grenade explodes, a magic net snares the nearest target (maximum range is 20 feet/6 m). Dodge to escape the net works as usual. Only one target will be affected per grenade. **Cost:** 4000 credits each.

Note: The cost of these items may vary by as much as 10% less or 50% more. They are made by alchemists, some clans of **techno-wizards** and occasionally, dragons.

## Singing Arrows (Nari-Kabura)

The ancient Japanese warriors sometimes used hollow "flute arrows" or "whizzing arrows." The shafts of these arrows were hollowed out, and depending on the way they were carved, they made a different type of noise when fired. They were used as signals, or to spook enemies. A few of these arrows were enchanted so that the eerie whistling sounds produced actual magical effects. Alchemists often sell or give (usually in return for some service) these arrows to warriors and adventurers. The arrows inflict less damage than normal (a mere 1D4 S.D.C.), but their powers and effects are based on the sound they make, not their striking damage. After an arrow is fired, however, its enchantment is lost, and the arrow shatters when it hits the first solid obstacle. **Note:** All arrows are equal to a 5th level spell and require a 16 or higher to save. Some of the most common arrows include:

**Terror Arrows:** The whistling sound is enchanted to produce fear in a 100 foot (30 m) radius around it. The arrow is typically shot into a group of people. Those in the area as the arrow goes howling by must save vs horror factor 16 or suffer the standard penalties. **Cost:** 2,000 credits each.

**Arrows of Exorcism:** The enchantment is designed to produce fear and discomfort among spirits/ghosts/entities, oni/demons and faerie folk. The arrow has an effect radius of 100 feet (30 m). Such creatures must make a save vs magic (16 or higher) or they'll be stunned for 1D4 melee rounds (automatically lose initiative, all combat bonuses are reduced by half and attacks per melee are reduced to one). Furthermore, a lesser demon will leave the person it was possessing and those possessed by greater demons or powerful forces will be made known (appear for an instant as a ghost image over the person), but their possession is not broken. **Cost:** 4,000 credits each.

**Arrows of Enticing Beauty:** As it is shot, the arrow creates beautiful, mesmerizing flute music. Those in the 100 foot (30 m) radius of effect must make a save vs magic (16 or higher) or become entranced by the beautiful tunes. They stop to listen to the music, have no attacks, but can defend themselves. Prowling around the entranced characters without being noticed is automatic. Even after the arrow music is gone, the affected people remain in a distracted, contemplative state for 1D6 rounds (no initiative, and -2 on all combat moves and bonuses). **Cost:** 3,000 credits each.

**Arrows of Agony:** The whistling sound is incredibly painful, paralyzing victims with pain. The radius of effect is 100 feet, (30.5 m). Characters must save vs magic (16 or higher) or suffer the effects of the agony spell. **Cost:** 6,000 credits each.

## Tanto of Hellish Poison

This is a powerful martial arts weapon used mainly by the mystic ninja clans, and then only by the elusive chunin or master ninjas. Some demon fighters, especially the cold-blooded Bishamon monks (see the *Bishamon Fighting Monk O.C.C.*), use this weapon as well, for its eternally poisoned blades can affect even dragons and supernatural creatures. The tanto is a Japanese knife with an 8 inch, chisel-point blade. The knife's blade and handle are solid black, but the blade also has a purplish sheen along its length and point — the lethal poison.

The tanto inflicts 3D6 S.D.C. to normal beings and 4D6 M.D. to supernatural beings and M.D.C. materials, like the armor of borgs or bots. If the flesh of the victim is touched, the target must save vs poison (15 or higher). On a successful save, the poison still inflicts an additional 3D6 points of damage directly to Hit Points or M.D.C. On a failed save, the poison does the 3D6 damage as above, plus it courses through the victim's body, filling it with agony. The victim loses initiative and one melee attack per round, all combat actions are at -2, and all skills are at -15%. These effects last for 1D6+2 hours! Every hour after being struck, the victim loses 1D6 additional Hit Points or M.D.C., and must make a save vs lethal poison or temporarily lose 1D4 points of P.E.! If the P.E. of the target is reduced to zero, he dies! The poison damage cannot be regenerated by supernatural creatures until the 1D6+2 hours have passed, but magic healing and healing potions can restore some of the damage (half per each application)!

Many monks, **yamabushi**, priests and defenders of the innocent consider these weapons to be tainted and *never* use them. Some stories claim the blade is coated with the living blood of a greater demon or god of darkness, which is why it works against supernatural beings. Only the most zealous and driven Bishamon monks will use it.

**Cost:** At least eight million credits! Extremely rare!

## "Ten-Thousand-Strength" Nunchakus

These are items that were enchanted by **Okinawan** mystics in the years before the Rifts. The **nunchakus** inflict 3D6 M.D. per strike and grant the wielder one additional attack per melee round. A few martial arts secret societies have a few dozen of these weapons; several more are family heirlooms, handed down from father to son over the centuries.

**Cost:** 500,000 credits

## Whirlwind Naginata

This powerful magical weapon was created for the use of the highest female samurai in combat, the occasional male samurai, and is favored by sohei warrior monks. Only a few dozen are known to exist. The magic **naginata** inflicts 3D6+6 M.D.; furthermore, it has the following powers:

**Art of Defense:** If the character makes no attacks for that entire melee round, he will automatically parry (no roll needed, except on a critical strike from an enemy or natural 20) all attacks against him equal to

his total number of melee actions per round. These automatic parries defend against hand to hand and missile attacks (arrows, thrown weapons, and bullets).

**Whirlwind:** Four times a day, the wielder of the magic **naginata** can call upon a special magic whirlwind. This is done by spinning the naginata in a circle above one's head (takes two melee attacks/actions). The whirlwind can carry the wielder up and fly at speeds of up to 60 mph (96 kph). Also, while surrounded by the whirlwind, arrows and thrown weapons will be automatically deflected by the winds. Energy and slug-throwing weapons hit normally. The duration of the whirlwind is five minutes per each time it is used.

**Cost:** 5+ million credits. Extremely rare.

## Zen Master's Bows

These are ancient Japanese long bows, crafted and used by true Zen archery masters. Products of exquisite craftsmanship, these ancient bows are said to be imbued with the spirit of their makers. Each bow is a unique creation; only a few dozen of the lesser bows are said to exist in the world, and perhaps a dozen of the greater ones. Thus, they are priceless possessions. Only warriors trained in the ways of **Kyudo** (Art of **Bowmanship**) can use the special bonuses of these weapons.

The bows appear to be ordinary, albeit beautifully decorated and engraved. Those knowledgeable of Japanese arts and craftsmanship have a 30% (+5% per level of experience) chance of recognizing the work as the creation of one of the legendary **bowmakers** of the ancient past. When wielded by a student of kyudo, the bow contacts the wielder and instructs him on his powers. For everyone else, it is a superior bow with excellent balance and has a bonus of +1 to strike and does 2D6 S.D.C. damage for characters with the W.P. archery and targeting.

These weapons cannot be usually purchased; only the most desperate or depraved owners would part with them, or if they don't know what they have.

**The Powers of Zen Masters' Bows:** Lesser Zen Bows can have two of the powers below; greater ones have them *all*.

- +2 to strike
- By closing his eyes and drawing the bow, the user of the Zen Master's bow can see/sense invisible creatures. By making a save vs magic while drawing the bow, the archer can actually sense ninja using their art of invisibility powers and shadow **beasts!** Shoots with all his usual bonuses.
- By spending 1 P.P.E. point per arrow, the user can cause his arrows to do mega-damage to any mega-damage structure; this damage is doubled if the target is a supernatural creature (i.e., a 2D6 arrow would inflict 2D6 M.D. to robots and power armor, but 4D6 M.D. to supernatural beings).
- By spending 5 P.P.E., the archer can double his rate of fire for one melee **round!**
- By spending 10 P.P.E. per melee round, the arrows shot from this bow can fly through tiny openings, twist through the air and fly around corners and other cover to strike hidden enemies, provided the shooter knows exactly where the difficult target is!

**Cost:** 300 million credits minimum for a greater bow, and 40 to 80 million for a lesser bow. Super **rare!!**



## Greater & Greatest Daisho Rune Swords

All samurai warriors are gifted with powerful magical katanas and **wakizashis** (the Daisho, or "paired swords"). Some master sword makers have gone even further, creating incredibly powerful greater and greatest rune weapons. The weapons listed below are some of the examples of these powerful items. Greater Daisho sets are not gained lightly; they are inheritances, or badges of high office or incredible heroics. Powerful feudal lords and the most notorious warriors of the land are usually the only people who have them. These super-rare weapons would be considered priceless and could fetch in excess of 400 million credits.

### Daisho of the Relentless Warrior

This daisho set has white scabbards and handles, with a dragon pattern inlaid in gold, and jade for the dragon's eyes. It was forged in the 16th century by a legendary swordsmith. According to legend, it only appears to be wielded by the greatest champions of Japan. The last time it was used, it was in the hands of a samurai commander who fell in battle against an oni horde; before he died, the warrior slew no less than two dozen demons single-handedly. This was over ten years ago; the sword has yet to reappear, and many a young samurai is working twice as hard, hoping that he might be the chosen one.

The two swords have all the qualities of the mystic Daishos plus the following:

- **Principled Alignment:** It can be used by principled or scrupulous characters only.
- **Extra Damage:** The swords each inflict 1D6×10 M.D. damage, and they always inflict mega-damage (including against non-supernatural M.D.C. body armor and robots).
- **Relentless Strength:** Three times per day, the wielder of the sword can call the spirit of the sword to strengthen him. The mystic **meld-**

ing lasts two minutes per level of experience of the samurai. During that period, the character's strength is raised by 10 and becomes supernatural. Furthermore, his hit points and S.D.C. are doubled and become M.D.C. points! The character is surrounded by a green aura of energy while the power is active; many oni and dragons know what the aura means, and will be terrified (effective Horror Factor of 15).

- **Healing Power:** The sword can heal the wielder three times a day for 3D6+3 points.

## Daisho of the Storm

The **Daishos** of the Storm were a set of ten pairs of swords, created in legendary days by a powerful Daimyo to honor his most trusted warriors. The swords were dedicated during their forging to the gods and spirits of the storm, the dreaded tsunamis and hurricanes that strike fear in the souls of all Japanese. After the Coming of the Rifts, this symbolic dedication became a magic power, making the ten pairs of swords ultra-powerful, enchanted weapons, able to perform a variety of amazing feats.

The whereabouts of only three of the ten sets of swords have been determined. Two belong to very famous samurai of the New Empire, one of which is a direct descendant of the original swords' owner. The third one belongs to a ronin who abandoned the service of his lord and now lives like a hermit in the mountains. Many a young samurai that challenged him for the sword has lost his life. The other seven could be anywhere, lost in the chaos of the Rifts or in the hands of some unknown champion.

In addition to the normal powers of the swords, the Daishos of the Storm have the following qualities:

- **Scrupulous alignment.**
- **Damage:** The **katana** inflicts 1D4×10 M.D. to supernatural beings, and 3D6 M.D. to anything else. The **wakizashi** does 5D6 M.D. to supernatural beings and 3D6 M.D. to non-supernatural objects.
- **Call of the Storm:** This power can be conjured three times per day. By swinging the swords around, the warrior can generate a storm around him (covers a 500feet/152 m radius around the character). The power lasts one minute (4 melee rounds) per level of experience of the swordsman. Furthermore, once per melee he can direct a wind gust, a lightning bolt, AND a blinding downpour of rain at a specific target. Each counts as one of his melee attacks, each can be used only once per melee round (so a character with four attacks per melee could use each of these attacks once and attack normally once more).

The wind gust has a speed of 100 mph (160 kph) and it will knock most characters down, including those in power armor, and will push down or knock over any vehicle or robot weighing less than a two tons.

The lightning bolt inflicts 4D6 M.D. and has a range of 1000feet (305 m).

The downpour of rain, when focused on one character, will blind and distract the target, with penalties of -4 to strike, parry and dodge, and -4 on initiative for 1D4 melee rounds. Furthermore, the character can only see 10 feet (3 m) in front of him.

## Ghostly Katana of Soul Slaying

Only four of these swords (no **wakizashis** were ever built) are known to have been created. They were the fruit of *Hideo the Mad*, a sorcerer, swordsman and sword maker of legendary skill. Hideo was said to have trafficked with dark powers during his youth, at the cost of much of his sanity. However, later in life he became a staunch champion of good. The Ghostly **Katanas** were made not with metal, but with

Soulstuff, an alloy distilled from the very life force of living things! Or so it is said. Hideo worked in an unusual forge, making all four swords almost simultaneously. When he was done, Hideo sacrificed his own life; his apprentices claimed the ancient **swordmaker** seemed to pulled in four directions at the same time and vanished, disappearing into the blades. The feat has so far been unmatched in history (at least on Earth — the magic technology is from **Wormwood**).

The swords blades appear to be normal until they are used in combat; then they become ghostly and **semitransparent**. This ghostly blade goes through armor and any obstacle to strike directly at the body of the target. The sword is particularly devastating to supernatural beings, and utterly destructive to the undead (in fact, one legend claims that vampires have hidden two of the four in some dark place). The ghostly blades can also strike insubstantial beings without penalties (astral travelers, entities, alien intelligences in energy form, etc.).

Only one sword has been located in the years since the Great Cataclysm. It is in the hands of a samurai who for years has fought on his own against the forces of darkness. The whereabouts of the other three remain unknown, although some pre-Rifts records preserved in the New Republic seem to indicate that one, or perhaps two, of these weapons were purchased by antique dealers sometime before the Cataclysm, and taken to the United States, the city of Chicago to be precise. So it is perfectly possible that one or two of these powerful weapons is buried under the rubble of that city or even sitting in a pawn shop in the burbs.

In addition to the common powers of all mystic swords, the Ghostly Katana have the following qualities:

- **Damage:** 1D4×10 M.D. to supernatural beings, 2D4×10 to vampires and other types of undead. 6D6 S.D.C. damage to normal human beings/mortals.
- **Ghostly Blade:** This semitransparent blade will penetrate all suits of armor (including M.D.C. armor and power armor, but not robots or vehicles), force fields, and other barriers, and inflicts damage directly to the creature's S.D.C. and hit points (M.D. to supernatural beings). The blade can also affect insubstantial creatures, including vampires in mist form!
- **Sense Evil:** The character can sense the presence of the supernatural (treat as presence sense, sense magic and sense evil) within a radius of 30 feet (9 m) plus 10 feet (3 m) per level of experience.

---

# Magical Items

---

## Bottomless Purse (Kanebukoro)

These unusual items carry money, food, and other valuables. The purses are enchanted to provide a seemingly endless stream of goods or cash. Thus, they are very highly valued. The magic purses were created as rewards for dedicated adventurers and travelers; their purpose was to ensure that the owner never lacked the basic needs and desires. However, it was not created to provide infinite wealth for the greedy. Would-be hoarders and exploiters are always foiled by the magicks of the purse.

**There are three types of purses.** One contains money, usually in the form of featureless silver coins (often square, with a hole in the middle) worth 2D6 credits each (roll for each coin pulled out to determine its market value).

The second type contains rice cakes and similar bland but nourishing foodstuffs.

The last, and most powerful type, is the Purse of Wishes, which contains any small ORDINARY object the wearer wishes for, from food and drink to grappling hook or a sword.

**The limits** of the purse become obvious to those who try to abuse their powers. For one, only a handful of items can be brought out at any



one time. Trying to empty the purse by shaking it produces nothing; the owner must reach in and "grab" the item(s). A handful of coins is 2D4+6 of them. The money purse can be used ten times a day.

One handful of food is enough to feed a person for one meal (any basic food stuff is possible). The food purse can only be used four times a day (four meals total).

The purse of wishes can only be used three times per day. The food taken out of the Purse of Wishes can be more appetizing, but is still only enough for one meal. More money can be extracted (1D6×100 credits per use), and it can be in the form of credits, gems, and other valuables. The wish purse can also produce small, basic items such as a knife, hatchet, short sword, 10 to 100 foot (3-30.5 m) length of rope, a set of lock-picking tools, a warm blanket, a pair of sandals, a bottle of wine, and similar. Rare items, magical weapons, energy weapons, alien technologies and the like will not be provided by the purse.

Furthermore, characters cannot hoard items. Every item, all the food, and any moneys taken out of the purse, must be used in the course of that day. Anything left over disappears! Thus, enough to provide for day-to-day needs is allowed, but any excess is lost. Some stories warn of terrible curses that plagued people who tried to circumvent the limitations of the purse, ranging from losing all their wealth in a rash of bad luck to worse! (G.M.'s **Note:** If a player tries to violate the spirit of these limitations, feel free to hose his character with curses, bad luck and mishaps. If he keeps abusing the magic powers, the purse will disappear, taking with it all small valuables the character owns!).

**Cost:** Rarely for sale. Shinto temples, alchemists and other places of magic sometimes offer it as a gift for some great service to them or the community. Price ranges from 100,000 to 200,000 credits for the lesser types and 5 to 10 million for the wish purse. All are fairly rare, but the wish purse is extremely rare.

**Note:** The purse only works for the one it was *given to*, so if stolen it will be useless, but if given to another person as a gift, it will work fine. Thus, these items can be passed on from generation to generation.

## Fan of the Forest Wind

This inoffensive-looking item is a hand-held fan with a forest drawing on it. When waved about around the holder, however, a swirling wind carrying dry leaves appears. The leaves look like common leaves, the kind one would expect in a forest during Fall. The leaves will appear wherever the fan is used, be it a forest or inside an airplane hangar. After one melee round, there will be so many leaves flying around that the character will be nearly invisible; trying to strike him requires a called shot at -5 to strike! During the confusion, the character can try to run away, hide, or strike from concealment.

Some ninja adepts use this fan as an aid for their disappearing tricks. The swirling leaves are also used to start ambushes, confusing and blinding the enemy before attacking. The fan can create a whirlwind of flying leaves large enough to cover a 30 foot (9 m) area.

**Cost:** 50,000 credits.

## Hat of Invisibility (Kakuregasa)

This magical item is a simple straw hat that looks ragged and ordinary. It is sometimes shaped like the common Asian conical hat; others look like straw cages or boxes that surround the head, with a small opening for the face. Six times per day, the hat's magic can be activated, making the wearer invisible for up to one hour. The hat is often a gift from friendly **kami** (spirits), monks, priests and other people and creatures of magic or power.

**Cost:** Rarely sold. Price will range from 30,000 to 100,000 credits.

## Heavenly Speaking Flute (Ame-no-nori-goto)

A flute, often carved out of bamboo, bone or wood, with no obvious marks or signs to show it is special. Some Taoist and Shinto mystics create this item to facilitate communication with entities, ghosts and other spiritual beings. The flute has three powers, each of which has its own tune that must be played. Each tune can be played three times a day, for as long as an hour at a time. Fighting monks, monster hunters and mystics are often given this magical item as a gift or reward for services rendered.

### The Powers of the Flute:

**Song of Heavenly Senses:** While playing this melody, the character can see the invisible, including any entities, energy creatures, etc. The character can also feel when he's within 5 miles of a ley line, a nexus point or other place of mystic power, and he gets a sense of the distance and direction of the place. Also, the flute-player can feel the presence of supernatural evil (60 ft radius).

**Song of Spiritual Comfort:** This song is pleasurable and amusing for spirits and entities of good alignment, and painful and fear-inducing for evil entities (spirits of a selfish alignment have a 50-50 chance of being affected either way; generally, those who mean well towards the player will feel pleasure). Good spirits will typically help the character with information, advice and small tasks in return for an hour's worth of music. Evil spirits must save vs magic (14 or higher) or will be forced to flee the area, but even those who make their save will only have half their number of attacks, bonuses, and skill values as long as they are within 300 feet (91 m) of the flute player or if they can still hear the music.

**Song of Summoning or Banishing:** The music can summon an entity of the character's choice, or can banish a spirit, possessing demon or similar creature. In either case, the entity in question gets a savings throw (16 or higher) to resist the summoning or banishing. In addition, other characters performing an exorcism while the music plays, are +20% to have successful results.

**Cost:** Very rarely sold; will only work for people with good alignments (unprincipled and aberrant characters who have vowed to fight demons and the supernatural have a 50% chance of being able to use one; roll once to determine whether or not the character can EVER use these flutes). In the few cases where it has been sold, the price has ranged from 50,000 to 100,000 credits.

## Holy Incense Burner

Another Shinto creation, the Holy Incense Burner uses special magical powders to defend against spirits, demons, and elementals. Each type of creature requires a different type of treated incense powder. Typically, each magic burner comes with 1D4 packages of each of the three most common powders. Shinto temples can manufacture more powders for worthy characters; some Japanese alchemists and dragons can also create the powders and sell them.

When a powder is put into the lit burner, it burns and produces a thin cloud of the appropriate color. The cloud expands in one melee round to cover a radius of 30 feet (9 m) around the burner. Creatures of the type affected by the powder must save versus ritual magic (16 or higher) or they will be unable to come into the cloud. Those who make the save and step into the cloud will suffer 1D6 points of damage (to M.D.C. or hit points as appropriate) every melee round, and will be at -2 on initiative, strike, parry and dodge due to the stinging and painful cloud.

### The most common types of powder include:

**Ghosts and Spirits:** Works against all forms of entities, from possessing and tectonic to the common haunting spirits. If the spirit was possessing an object and was immersed in the cloud, a failed save will mean it has been exorcised.

**Dead and Undead:** This powder affects zombies, skeletons and other walking dead, as well as vampires and other greater undead beings. While immersed in the cloud, vampires cannot use their psionic powers, nor can they change in shape; damage affects them even if they are in mist form!

**Oni and Demons:** Affects **Oni/demons**, devils, and most evil supernatural beings with a physical form. Any magical or psionic powers the creatures have work only at half effect, range, and damage while caught in the cloud. Same is true of any magic they may cast from a safe distance, but into the cloud

**Cost:** Almost never sold. A burner with 1D4 packages of each of the three powders would cost at least 200,000 credits. Alchemists will sell powder packages for 1200-1800 credits each.

## Lantern of Protection

These Japanese lanterns have a number of symbols of protection inscribed on their paper walls. The lanterns are manufactured in Shinto temples, and are sometimes sold or given to those who travel in demon-infested areas. The powers of the lantern manifest themselves when it is lit; each lantern can be lit for up to 24 hours. The lamp can be used for less than 24 hours for repeated uses, but each time it is lit one hour's worth of its magic is used up. The lantern's blessed light makes it painful for **demons/oni**, ghosts, supernatural creatures and evil **kami** to approach (does not affect dragons, immortals or mortal priests and practitioners of magic). Such supernatural beings must make a save vs psionics to muster the willpower to approach within 20 feet (6 m) of the lamp, and even if they do so, they lose half of their melee attacks, half of their combat bonuses, and they cannot use their magic within the light of the lamp. **Furthermore**, all people within the 20 foot radius are at +3 to save versus any supernatural effect (but *not* magic or psionics used by non-supernatural beings, or dragons). This bonus works against both magical and psionic powers used by demons and supernatural creatures.

**Limitations:** The main problem with the lamp is that it is a fragile item, only 12 S.D.C. and easily flammable. Also, it can only be used for 24 hours or 24 uses whichever comes first, before it becomes useless. Sohei, samurai, traveling monks, and the occasional demon queller can get 1D4 of these valuable lamps from a Shinto temple, but only if they manage to convince the temple masters that their quest is worthy and their need is great — a high-level warrior or mystic might be refused because he does not "need" mere trinkets that could help a less powerful traveler.

**Cost:** When sold by unscrupulous merchants or bandits, the lantern will fetch 50 to 200 credits.

## Living Kami Statues (Kiagan-Kuyo)

The art of Kiagan-Kuyo is the greatest achievement of a master sculptor: the making of a statue so finely detailed and close to perfection that the god or spirit may animate it for short periods of time! These statues are a special brand of magical items, created by the master artists of their time. The ritual of creation has its own magic, and the Japanese believe it is possible to breathe life into such a creation if the creator is skilled and dedicated enough.

Over the centuries, hundreds of such statues have been built, each with the spark of magic in them. The Great Cataclysm and the elevated levels of magical energies now mean that these statues can be brought to life with the proper rituals. A number of magicians, alchemists, priests and monks have learned the proper ceremonies needed to revive the statues. They are now used as temple guardians, bodyguards, and for similar purposes. The statues are automatons that can be used for good or evil, although if the kami or god depicted is of a good alignment, there is a good chance (65%) that it will deactivate itself rather than carry out an evil action, and vice versa.

The sizes of the statues range from tiny (2-5 inch tall figurines), to medium (1-3 foot/0.3-0.9 m statuettes), human-sized (4-7 feet/1.2-2.1

and giant (10-20 feet/3-6 m). Activated or not, the statues become M.D.C. constructs after the Great Cataclysm (an easy method for characters looking for magical statues is to try to shatter them with a hammer or S.D.C. explosives). They are built of a variety of materials, from jade to marble to ivory, and the depictions range from wise men to warriors. The statues are the equivalent of golems, however, and can only be made to fight, carry objects, and similar tasks. The actual power of the statue depends on its size:

**Tiny figurines** have 1D4x10 M.D.C. and a P.S. of 6 (supernatural; with leverage, they can move/shift as much as 600 pounds!). They are +2 to strike and parry, +6 to dodge, and can do 1D4 M.D. with an attack. If the statue has weapons, the attacks inflict 1D4+1 M.D. Note: The weapon must be part of the sculpture.

**Small Statuettes** have 2D4x10 M.D.C. and a P.S. of 12 (supernatural). They are +2 to strike and parry, +4 to dodge, and inflict 1D6 M.D. with their attacks. If the statuette has a weapon, damage is raised to 2D4 M.D.

**Human-sized Statues** have 3D6x10 M.D.C. and a P.S. of 20 (supernatural). Bonuses: +3 to strike, parry and dodge. Damage: 2D6 M.D. with a punch, or 3D6 M.D. with a weapon (if any).

**Giant Statues** have 1D4x100 M.D. and a P.S. of 1D4x10 +20 (supernatural). Bonuses: +2 to strike and parry, +1 to dodge. Damage: As per supernatural P.S.; add 2D6 M.D. if it has a weapon.

Activating the statue requires a ritual; magician, priestly and alchemist characters have a 35% chance (add 4% per level of experience and I.Q. bonus if any) of discovering the right ritual through research. The activation ritual costs 2 P.P.E. for tiny statues, 4 P.P.E. for small ones, 10 P.P.E. for human-sized and 20 P.P.E. for giant ones. Once activated, the statue will obey the caster's commands for 1 hour per level of experience of the caster. If destroyed, the enchantment is lost and the pieces become ordinary S.D.C. materials.

**Cost:** Tiny: 50,000 credits; small: 100,000; human-sized: 200,000; and giant: 500,000 credits. Add 1D4x10% for artistic beauty and value.

## Mirror of True-Seeing

These items are typically small hand mirrors with a gilded border, decorated with a dragon pattern. Their magic can be used six times per day. Each time, the owner can tilt the mirror so he can see the reflection of a person, object or area. The mirror will show the owner the true essence of that person. This will cover everything from alignments (characters of evil alignments will have ugly or even hideous faces), to true shapes (in the case of changelings and other shape-shifters), and supernatural presences (supernatural beings will be surrounded by a bright red or purple aura in the reflection). Disease, anguish and mental problems will also appear in the mirror, usually as taints on the person's skin, a haggard appearance, etc.

These mirrors are often carried by monks and demon hunters; they use them to discover their quarry. Some itinerant priests and helpful monks also favor using them to help normal people in need, finding the problems and ailments of common folk by looking at their reflections.

**Cost:** 200,000 to 400,000 credits; rare.

## Powder of the Heavenly Winds (Kamikaze)

The Heavenly Winds or Kamikaze have played many roles in Japanese history. During the 13th century, a Mongol fleet was about to invade and devastate Japan when a freak storm destroyed it; the storm and its deadly winds were called the Kamikaze; "winds of Heaven" or "spirit winds." During World War II, as the Japanese faced total defeat at the hands of the American fleets, they resorted to the desperate tactic of sending pilots in flimsy planes loaded with explosives, on suicide runs against American ships. These suicide planes were also dubbed "divine winds" or kamikaze.

The Kamikaze Powder is made from ground parchments on which a number of incantations to air **elementals** are made. The powder is then stored in a hollowed out length of bamboo with wax seals at each end. To activate the item, the owner rips off one of the seals and scatters the powder in the air (takes one melee **attack/action**). As soon as the powder is in the air, the character who tossed it can control winds of up to 200 mph for 1D6 +2 minutes! These winds will knock down most characters and any robot weighing less than 15 tons. Furthermore, once per melee, the character can direct a gust of magical cutting wind that will inflict 3D6 M.D.! These wind blasts are at +3 to strike. The winds can be made to extend over an area of 400 feet (120 m); the hurricane forces will destroy houses and huts, inflict 4D6 S.D.C. damage per minute to people, animals and property, and will generate confusion and panic. Once the 1D6 +2 minutes are up, the powder dissipates and the effect is over. Each container of Kamikaze powder can only be used once.

The powder is rare and very expensive. Only sorcerers and alchemists have ready access to it. In the fight against the Oni and other demons, some champions may sometimes be rewarded with one or two containers of the powder.

**Cost:** 200,000 to 400,000 credits per container.

## Tattoos of Strength

This special magic was created by outlaw sorcerers working for the dreaded **Yakuza**, the criminal gangs of Japan. **Yakuza** members wear

elaborate body tattoos to represent their rank; these tattoos depict dragons and snakes. The Yakuza mages developed a special ritual in which magic powers were granted to the wearer as the tattoo was inked into the gang member's skin. This ritual is a gift given only to the most notorious and prominent Yakuza enforcers. **Note:** This magic is not a form of Tattoo Magic as practiced by True **Atlanteans** and the **Splugorth** (see **Rifts Atlantis**), but a lesser, less flexible form of magic.

The Tattoos of Strength can be activated four times per day; each activation can last up to one hour, and requires a mere mental command. When activated, the body tattoo glows with an unearthly green light, shining through clothes and even giving the character a greenish hue through environmental armor. During the activation period, the tattoo wearer becomes a supernatural being, with P.E.x3 M.D.C. (cumulative with any other M.D.C. granting powers or abilities), and +6 to P.S., which becomes supernatural. While the power is on, however, the tattoo wearer takes double damage from any weapons designed to combat supernatural beings, including the samurai rune daisho and weapons made from the wood of a Millennium Tree.

**Cost:** Available only to Yakuza enforcers or their allies. Cost is upwards of 60,000 credits.

---

# New Empire & Traditional O.C.C.s

---

## Warrior & Monk

### Occupational Character Classes (O.C.C.s)

True Samurai O.C.C.

Ronin O.C.C.

Mystic Ninja O.C.C.

Bishamon, Fighting Monk O.C.C.

Sohei, Warrior Monk O.C.C.

Yamabushi (priest) O.C.C.

Demon Queller O.C.C.

Tengu R.C.C.

## Traditional Samurai Warrior O.C.C.

### a.k.a. The "True" Samurai

*Few countries have a warrior tradition as long and as exciting as that of Japan. It is a tradition found particularly in the person of the romantic, loyal and self-sacrificing knight of old Japan, the samurai. He is the valiant lone swordsman, the ultimate individual warrior. He is the esthete, appreciating the beauty of cherry blossom, and seeing in its brief career his own short and glorious life. He is the commander of a host on the battlefield, the assassin in the night, the keeper of peace, the aristocratic administrator and the avenger of his master.*

*At various times in Japanese history the samurai fulfilled all these roles.*

**Stephen R Turnbull** — from **The Book of the Samurai; The Warrior Class of Japan**

After the Great Cataclysm, decades of hardship followed. Millions would follow the billions of lives claimed during the calamity of the Coming of the Rifts to their deaths. To many of the survivors on the is-

lands of Japan, the destruction and the return of the gods and spirits of the past was a sign. A sign that they had lost their place in the world — perhaps the cosmos — and that they must again find balance and harmony in a lopsided world. As a result, the people abandoned the ways of technology and the enlightenment of science to embrace the old traditions and to build a New Empire. Thus, out of the darkness came a new age of enlightenment led by the warrior scholars and heroes known as the *samurai*.

The *new* samurai of the New Empire are said to be the embodiment of the people's will to survive. A noble and powerful warrior dedicated to ridding the land of the inhuman invaders and restoring Japan to its former glory.

The **samurai caste** is more than a title or occupation. It is a social rank and a sign of education and nobility. The samurai are the elite in a military government that rules the land and governs its people. Samurai families or clans can trace their lineage over 200 years, some for a thousand years before the Coming of the Rifts. In addition to serving as mounted knights, defenders of the land and administrators within the New Empire, most samurai **arelandowners**, scientists, engineers or other noble positions.

One benefit of the samurai caste is the *right* to carry weapons! Peasants (60% of the population) and eta (15%) are not allowed to carry weapons, except for farm tools that might substitute for weapons, such as the sickle, knife, and wooden staff (although some also carry easy to conceal items such as the short sword, knives, chains, and **nunchaku**). Visitors, ronin, mercenaries and adventurers may carry weapons but they are viewed with great suspicion and caution; it is best if they keep their weapons sheathed and even covered, wrapped in cloth or kept in a bundle.

The *daisho*, a matched pair of katana and **wakizashi** swords, is the symbol of the samurai, so all true samurai warriors carry them (as do many impostors, meres and false samurai). The *long bow* is also a traditional favorite weapon of the samurai, but the warriors are not limited to the sword and the bow, most are skilled in at least two other weapons.

The "top notch" hair style is also a sign of position as a samurai; to shave the head is usually to indicate temporarily leaving the samurai position for religious reasons. This can mean becoming a monk for several months to a few years, or a period of meditation, fasting and contemplation at a monastery or religious retreat. Religious contemplation usually lasts several months (2D4), but can take years; such a period of retreat usually has to do with reflection about one's future, change or repentance for some terrible deed.

## Bushido Code of the New Empire

Bushido, the warrior code, is that which separates the Samurai from the lower castes through a concept of honor. The code includes complete loyalty to their shogun or daimyo, honesty, courage, politeness and self-control. To the dedicated samurai, an individual's honor is as important as personal wealth, glory or well-being.

### Gojo (the 5 virtues of the samurai)

#### 1. Sincerity & Honor

- Always remember and repay one's *giri* (duty, obligation or debt of gratitude — especially to one's lord).
- The purest expression of one's gratitude is to die for one's lord (daimyo).
- The samurai has but "one word." Once he has pledged his word he is bound by it, and nothing can dissuade him from fulfilling the duty he has undertaken.
- Any obligation undertaken by a samurai requires a willingness to undergo any sacrifice in order to repay a kindness, or honor a commitment.
- Always maintain one's principles.

#### 2. Wisdom

- Use "common sense" in all aspects of life.
- Beware of magic and the supernatural. Know it in its many guises.
- Beware technology. Avoid it and admonish it.
- You die in vain if you do not accomplish what you set out to do.
- You live as a coward if you forsake your objective and continue to live.
- To miss an objective and choose death (dies trying or commits *seppuku/ritual suicide*) —

#### 3. Propriety

- Devotion to duty above all else.
- Exhibit self-control in all things.
- Avoid bringing disgrace to one's lord (daimyo).
- Avoid bringing disgrace upon oneself — observe courtesy and etiquette.
- Observe all due proprieties in one's dealings with others.
- Put oneself above material reward, especially money; remain true to oneself and one's lord.
- Avoid foul language, especially in front of women, children and nobility.
- Keep to tradition — avoid using the technology that once destroyed Japan.
- Show respect to authority, especially one's lord and the Emperor.
- Fight with honor.
- Avenge the wronged.

#### 4. Benevolence

- Show kindness. It should not be difficult to show some measure of kindness, especially to the less fortunate, innocent, or downtrodden.
- Avoid thoughtless cruelty even to those without honor or courage lest you become like them.
- Avoid torture, especially as an act of revenge.
- Administer swift justice.

- Administer swift and gentle mercy.
- Protect the innocent.

#### 5. Courage

- Cultivate a fearless spirit to better serve one's master and oneself.
- Death is inevitable, meet it as a warrior.
- Recognize the face of one's fears, learn to look it squarely in the eyes, and meet it head on.
- Defend one's master/daimyo/shogun and all that is his.
- Defend the weak or innocent if orders allow.

### Gorin (the 5 relationships of the samurai)

The samurai's loyalty and commitment is listed in order of importance:

**1. Samurai to Lord:** Absolute loyalty to daimyo and emperor, even above the tenants of Bushido.

**2. Father & son/teacher & pupil**

**3. Husband & wife**

**4. Senpai's: juniors & seniors**

**5. Friends—peers & equals**

**Note:** Despite the Samurai's allegiance to the shogun or daimyo, the warrior could challenge and fight the shogun or daimyo to replace him, without breaking the code of Bushido. Such challenges could occur as the result of a terrible injustice, tyranny and/or cruelty. In the past, this would involve war between entire samurai armies or clans. The losing side would have to swear allegiance to the new shogun or be slain. In history, the leaders (and sometimes entire armies) weren't given a choice and were beheaded.

Ceremonial suicide was an acceptable way of saving face and honor, but one could not kill himself if he owed any debts, until they were repaid.

## The Living Samurai Sword

All "true" samurai will have a pair of "true" samurai swords (*katana* and *wakizashi*). These swords are minor rune weapons with the life essence of a living being locked inside their nearly indestructible blades. The rune swords can only be created by a samurai who is 12th level or higher or by a Shinto master sword maker, most of whom are extremely old and considered to be "Living Legends." Some ancient *tengu* taught and blessed by the gods can also make samurai swords.

The creation process requires beating and "folding" the sword at least 400 times — the rune swords are folded a thousand times! This process also involves innumerable ceremonies, the summoning of mystic or cosmic energy (P.P.E.), and finally, the spirit of a living human being.

Low level swords are tested on a straw dummy for strength and sharpness. These are excellent S.D.C. weapons; the *katana* inflicts 3D6 or 4D6 S.D.C. and the smaller *wakizashi* does 2D6 S.D.C. They have superior strength and balance but are not considered "true" samurai swords.

The "true" samurai sword is tested by slaying a living **person/being** by chopping off the head and limbs. This individual is typically a condemned criminal. 80% volunteer for the ritual slaying, insisting that they are repentant and want their "**kami**" (spirit) to be "reborn" into the sword to make amends for their past wretched life. At the instant of death (the first strike, chopping off the head in a single gesture), the criminal's life essence is joined to the sword, making it a living weapon.

**Note:** The sacrificial subject must be a *human* (including human *eta* and foreigners). The creation of a samurai sword is considered a magic ritual requiring 1000 P.P.E. (the sword maker stores one P.P.E. point in each "fold" during the ceremonies of creation) and ideally, a willing subject. Its secrets are *never* taught to outsiders (+9 to resist psionic probes, drugs and mind control in regard to this great secret) and only senior samurai and legendary sword makers know its secrets. Many an



作宗乘兩

余俱利如之

EX  
51  
96

elder samurai and sword maker has perished at the hands of torturers rather than reveal the secrets of the sword.

## Samurai Rune Swords

The "True" Samurai **katana** and **wakizashi** are considered to be lesser rune swords. This means that they possess the following powers and abilities.

**Independent Personality** which can be *felt* by the samurai. Alignment: Any, but usually principled, scrupulous, unprincipled, or aberrant. Both the katana and wakizashi will have identical alignments. I.Q.: 3D4+2

**Telepathic Link:** The warrior and his swords are one, so there is a unique mental and spiritual bond between the three. The samurai can actually feel triumph in victory, **strength/courage**, compassion, fear and similar sensations from his rune swords, however, they do not actually speak words to him. These feelings are even stronger from ancient, pre-Rifts swords and the weapons sometimes "speak" to the warrior in his dreams.

**Nearly indestructible:** The blade never dulls and is impervious to magic, demons, **elementals**, elemental forces and energy (including lasers and plasma blasts). Only a god, Living Legend sword maker or another rune weapon can destroy a true samurai sword. To do so, the attacker must be deliberately trying to destroy the sword with each attack, ignoring the sword wielder and other attacks leveled against him. A Living Legend sword maker can crack the sword in half with his bare hands. This is done through a ritual ceremony in which he withdraws all the mystic energy and the living spirit from the daisho.

**M.D.C.:** A typical Katana has 2D4×100 M.D.C., ancient ones (pre-Rifts) have 1800 M.D.C.

A typical wakizashi has 1D4×100 M.D.C., while ancient ones (pre-Rifts) have 800 M.D.C.

Any damage suffered by the mystical weapons is regenerated at a rate of 10 M.D.C. per hour (20 points if ancient).

**Damage:** Katana 6D6 M.D.; wakizashi 4D6 M.D. Add 2D6 to ancient, pre-Rifts weapons (very rare).

**Parry Energy Blasts with Sword:** The samurai can attempt to parry energy blasts but is -5 to do so.

**Color:** Always silver, silver-blue or grey.

**Damage:** Katana: 6D6 S.D.C. to mortal foes and 6D6 M.D. to creatures of magic and supernatural beings.

Wakizashi: 4D6 S.D.C. to mortal foes and 4D6 M.D. to creatures of magic and supernatural beings.

1D6×10 and 1D4×10 respectively, for ancient samurai rune swords that predate the Coming of the Rifts (very rare but can be found throughout the world).

If one of the swords in the daisho is lost or destroyed, reduce the damage in the remaining sword by 1D6 points.

**Bonuses:** The rune swords provide their owner with a bonus of +1 on all saving throws.

**Compatibility:** The alignments of the daisho should be compatible with that of the samurai who wields them. If they are not, reduce their damage capabilities by half, there is no bonus, any communications are not peaceful or sympathetic, and the usual daisho bonuses (#2 in Special Training & Mastery, below) do not apply. Yet, when a pair of "true" samurai swords are found, given or acquired by a peasant, warrior or mercenary who is not of samurai lineage/noble birth, or even of Japanese heritage, but has the heart of a "true" samurai (a noble warrior), the spirit of the weapon will bond with him with all the benefits of the swords.

Note: Ancient, pre-Rifts samurai swords are extremely rare, but can be found scattered around the world. Many of these ancient swords were taken as souvenirs by conquering warriors and soldiers, purchased

by collectors, acquired by museums, or taken to other lands by descendants of the ancient samurai. Consequently, these great weapons are occasionally unearthed as artifacts, or are still held in the collections of lucky families.

Further, note that not all samurai or their swords are of a good alignment, about 25% are anarchist or evil.

## M.D.C. Armor

The samurai of the New Empire are given a suit of magic, M.D.C. armor. It combines strength and lightness and is made of traditional lamellar style plates (a series of very small plates or scales fastened together). Many are brightly colored or have bright color details, although the majority are rust colored. Heavy shoulder plates called *sode* are standard. The protective face mask (**mempo**) can be human looking, demonic or animal in appearance. The helmet can be simple or elaborate.

These suits of armor are usually created through magic ceremonies by priests, sorcerers, dragons, passed from generation to generation, captured from oni, or presented as gifts or rewards by the gods. Monks also, sometimes present the samurai with armor made from the bark of a Millennium Tree.

100 M.D.C. is typical, but it is not an environmental suit, so the wearer is not protected from fumes, gases, radiation, dust, smoke, disease, etc. Some suits have as much as 180 M.D.C., but these are uncommon.

---

## Special Samurai Training & Mastery

---

### 1. Way of the Horse and the Bow:

**Samurai Horsemanship:** Includes the ability to ride any horse-like creature at 54% +4% per level of experience. Roll under horsemanship skill whenever performing a leap or difficult riding maneuver (like riding and shooting bow and arrow).

**Samurai Bowmanship (kyudo):** This martial arts training enables the samurai to ride and shoot a bow at a full gallop without penalty (**yabusame style**)! Likewise, the samurai's balance and bow handling is such that he can shoot a bow without penalty from a moving vehicle, in mid-air, or from an awkward position (a swaying rope bridge, hanging upside down, leaping and shooting, etc.). Note: Skilled archers who are *not* samurai will lose all bonuses to strike and half their normal rate of fire when off balance or when shooting from a moving vehicle or horseback.

**Dodge Arrow Bonus:** The samurai can also try to *dodge* arrow attacks at only -2 to dodge, and energy blasts or gun fire at -4. As usual, a dodge counts as one melee **action/attack**.

**Rate of Fire:** Three at level one, +2 at level three, and +1 at levels 4, 6, 9, 12, and 15!

**Effective Range:** 600 feet (183 m) +25 feet (7.6 m) per level of experience.

2. **Daisho: The Great and Small — Samurai Swordsmanship:** All True samurai are master swordsmen and study Zen. The word samurai means "swordsmen."

**Paired Weapons:** Training in the use of two swords, one in each hand, to strike and parry simultaneously. Also see samurai hand to hand combat.

**Daisho Bonuses:** When using the daisho, the katana and wakizashi as paired weapons, the samurai is +1 on initiative, +3 to pull **punch/sword** strike (can stop short of striking within one centimeter or inflicts whatever damage desired, from one point of damage to half normal damage — a failed roll to pull means full damage is accidentally inflicted), and gets *one additional attack per melee round* when using the pair of swords. All "true" samurai have a daisho that are minor rune weapons.

**3. Chi M.D. Death Blow (special):** The samurai, **yamabushi**, warrior monks, and demon quellers can use a **chi** death blow attack against **oni/demons**, dragons, **elementals** and other supernatural beings and creatures of magic! When used against supernatural opponents, the attack inflicts mega-damage, even if it is normally an S.D.C. attack. The character can inflict the mega-damage strike with a punch, kick or hand-held weapon like a sword, axe, spear, club, etc., and does double normal damage plus P.S. bonus in mega-damage.

The chi attack is so devastating to the creature's body that it cannot *bio-regenerate* injury from a chi death blow for 1D4 hours! This is what makes the attack so deadly to the supernatural.

**Limitations:** 1. In addition to being limited to the above O.C.C.s, the character must be pure of spirit and intent. This means there can be no possibility of regret when this spiritual inner strength is used and it cannot be used in anger, fear or for revenge, even if the character wants to.

2. Counts as two melee attacks/actions.

3. Limited to supernatural beings and creatures of magic. The chi attack is not applicable against M.D.C. bots, borgs and power armor, nor ordinary human beings or S.D.C./hitpoint creatures.

4. The chi M.D. death blow is not applicable to guns or even the samurai bow and arrow.

**Note:** A "chi" death blow draws on the character's P.P.E. reserve of mystic, inner energy and can be considered a magical attack.

**4. Samurai Fan & the Art of Defense:** The samurai carries a fan with iron end plates with him, even into battle. It is often used to parry blows from his enemy's sword or spear. It also functions as a fan. **Bonuses:** W.P. Iron fan: +1 to parry at levels 1, 3, 6, 9, 12 and 15. It can be used in place of a sword or knife to parry attacks. **Damage:** 1D4 S.D.C.; it is not designed to be a striking weapon. **Note:** 30% are of mega-damage construction (2D6 M.D.C.).

**5. P.P.E. Bonus:** P.E x2 plus 1D6 per level of experience.

**6. Other O.C.C. Bonuses:** +1 to save vs horror factor at levels 1, 4, 6, 8, 10 and 12 and +1 to save vs mind control. Also see **Zanji Shinjinken-Ryo** bonuses.

## Hand to Hand: Zanji Shinjinken-Ryo

### Exclusive to the Samurai O.C.C.

Zanji Shinjinken-Ryo is an ancient school of samurai swordsmanship. Unlike some other forms of martial arts that incapacitate an opponent, **zanji** is designed to kill. Not wound, not injure, not knockout, but kill! A sword is an instrument of death, but also an extension of the swordsman. The secret of sword mastery is rooted in the ability of being able to respond instantly, without reflection, without hesitation, to anything that might happen. No amount of technical skill can benefit a samurai whose mind inhibits spontaneous response to the environment around him. In this sense, the sword and the man are of one mind and one spirit; a living extension of each other.

A samurai swordsman will carefully evaluate any opponent. Standing motionless, he will wait until the exact moment when, without thought or direction, he can instantly strike.

**The following techniques are known at first level:** Disarm, maintain balance, roll with **punch/fall/impact**, pull punch, Karate punch (2D4 damage), kick attack (2D4), knee and elbow strikes (1D6 damage), and the usual, strike, parry and dodge.

**Bonuses:** +3D6 S.D.C., +2 to M.E., +2 to P.P. and +1 to P.E.

#### Level:

1 Two attacks per melee to start; knife hand (2D4 damage); paired weapons, +2 on initiative, +2 to roll with **punch/fall/impact**, +2 to parry with sword or staff (in addition to W.P. bonuses), +3 to dodge, +2 to damage, and +2 to pull punch.

2 + One additional attack per melee, +1 to disarm, +1 to maintain balance.

3 +1 on initiative, +1 to strike, +1 to parry, critical strike from behind, and death blow on natural 20.

4 + One additional attack per melee and +2 to damage

5 Critical strike on a natural 18-20 and +1 to maintain balance.

6 +1 to roll with **punch/fall/impact**, +1 to dodge, +1 to maintain balance.

7 Power punch/stab (with hand or sword), jump kick and backward sweep kick.

8 + One additional attack per melee and +1 to dodge.

9 Death Blow!

10 +1 on initiative, +1 to save vs horror factor, and +1 to maintain balance.

11 + One additional attack per melee.

12 +2 to damage, +1 to save vs horror factor, and the knowledge and skill to create a "true" samurai sword.

13 + One additional attack per melee.

14 Double existing P.P.E. (inner spirit) and +1 to disarm.

15 + One attack per melee



## Samurai Family Background

The Samurai is a warrior with unsurpassed skills in hand to hand combat. Even in battles against M.D. opponents, the Samurai can hold their own, cutting opponents to ribbons with their paired blades. In addition to their fighting skills, they are also required to learn domestic related skills. The worth of a warrior is measured not only by his fighting ability but also by his skills in the gentler arts. **Note:** Select corresponding skills on the next table.



**01-10** Noble; a member of the samurai ruling class dating back 2D4×100 years before the Coming of the Rifts. Will have daisho that are 1D4×100+400 years old; a pair of greater weapons.

**11-20** A member of the new nobility and minor landowners with a farming background.

**21-30** A member of the new nobility and wealthy landowners with a background in farming, raising animals and administration.

**31-37** A mere *peasantfarmer* who took up arms and proved to have the soul of a warrior born. Family is considered noble farmers who have earned a tiny portion of land. This samurai may be looked down upon by arrogant aristocrats while others look upon him with the greatest respect because he is living proof that nobility and honor are not a birthright but can be acquired from any station in life.

38-47 A member of the new nobility with a military background.

48-52 A member of the new nobility with a background in medicine.

53-62 A member of the new nobility with a scholastic background; teachers, scholars, historians, arts and entertainment, etc.

63-70 A member of the new nobility with a background as a business owner.

71-77 A member of the new nobility with a political background.

78-83 A member of the new nobility with a religious background; monk, *yamabushi* or Shinto priests in the family.

**84-91** A member of the new nobility with a science background.

**92-00** A new samurai! A warrior who has risen through the ranks to prove himself a noble and honorable warrior from humble beginnings as a mercenary or ronin.

## Family Skills

Note: Select three skills from the categories listed, in addition to O.C.C. skills; all get a +10% bonus.

**Old nobility/administrators:** Make selections from *domestic* (particularly skills like bonsai, go, poetry, dance, sing, etc.) and/or *technical* categories.

**Minor landowner and farmer:** Make selections from *wilderness* or *physical* categories.

**Wealthy landowner and farmer or breeder of livestock:** Make selections from math and botany from the *science* category and/or any from *wilderness* or *domestic* categories.

**Military:** Make selections from *espionage* and/or *weapon proficiencies*.

**Medicine:** Make selections from *medical* and/or *science* categories.

**Scholar/teacher/historian:** Make selections from *science* or *technical* skill categories.

**Business Owner:** Make selections from math and archeology from the *science* category and/or any from the *rogue* or *domestic* categories.

**Politics:** Make selections from language, literacy, writing skills under the *technical* skill category and/or any from the *domestic* or *rogue* category.

**Religious:** Make selections from art, language, literacy, lore and mythology skills under the *technical* skill category and/or any from the *domestic* category.

**Science:** Make selections from the *science* category.

**New Samurai warrior:** Make selections from *rogue* or *wilderness* skill categories.

## The Traditional or "True" Samurai O.C.C.

**Alignments:** Any alignment, but 33% are principled, 33% aberrant, 16% scrupulous, 8% anarchist and 10% other.

**Attribute Minimum Requirements:** I.Q. 9, P.S. 10, P.P. 12, and P.E. 10 or higher.

## O.C.C. Skills:

Climbing (+5%)

Horsemanship (+20%)

Demon & Monster Lore (+15%)

Wilderness Survival (+10%)

Tracking (+5%)

Go (+10%)

Calligraphy (+10%)

Literacy: Japanese (+15%)

Languages: Japanese at 98% plus two of choice (+10% each)

Mathematics: Basic (+15%)

W.P. Samurai Archery (described above)

W.P. Sword (in addition to the Daisho described above)

W.P. Two of choice

Hand to Hand: Zanji **Shinjinken-Ryo** (described above; for males).

No combat alternatives are allowed.

**O.C.C. Related Skills:** Select four other skills, plus select one additional skill at levels three, six, nine and twelve. At level one the samurai also gets an additional three "background" skills (see table) as well as abilities from *samurai training and mastery*. All new skills start at level one proficiency.

Communications: None

Domestic: Any (+10%)

Electrical: None

Espionage: Any (+5%)

**Mechanical:** None

Medical: First Aid only or available as background skill.

Military: None

Physical: Any (except Acrobatics)

Pilot: None

Pilot Related: None

Rogue: Only available as a background skill

Science: Astronomy and Mathematics only.

Technical: Art, literacy, language, lores & writing only (+10%)

Weapon Proficiencies: Any ancient

Wilderness: Any (+5%)

**Secondary Skills:** The character also gets to select two secondary skills from the previous list at levels two, six and ten. These are additional areas of knowledge that do not get the advantage of the bonus listed in the parentheses. All secondary skills start at the base skill level. Also, skills are limited (any, only, none) as previously indicated in the list.

**Standard Equipment:** A suit of magic mega-damage samurai armor and helmet: 100 M.D.C. but is not an environmental suit — created by priests, sorcerers, dragons, passed from generation to generation, captured from oni, or presented as gifts or rewards by the gods.

Other gear is minimal, "Samurai" silks or cotton clothing, mega-damage body armor and several changes of clothes (kimonos), sandals, a utility belt, backpack, knapsack, 2 canteens, 2D4 days of rations and a quality riding horse.

Weapons include a daisho (rune **katana** and **wakizashi**), samurai longbow with 20 regular arrows, 6 silver tipped, and 6 magic arrows (more can be acquired later), two additional weapons of choice (usually represent W.P.). Magic weapons are a favorite, but other than the daisho and some arrows, the character starts with none.

**Money:** The characters daimyo usually supplies them with all their basic needs: clothing, food, shelter, horse, arrows and common S.D.C. weapons and armor.

In addition, the samurai usually comes from an at least modestly wealthy family and has a family house and village to go to (if not his

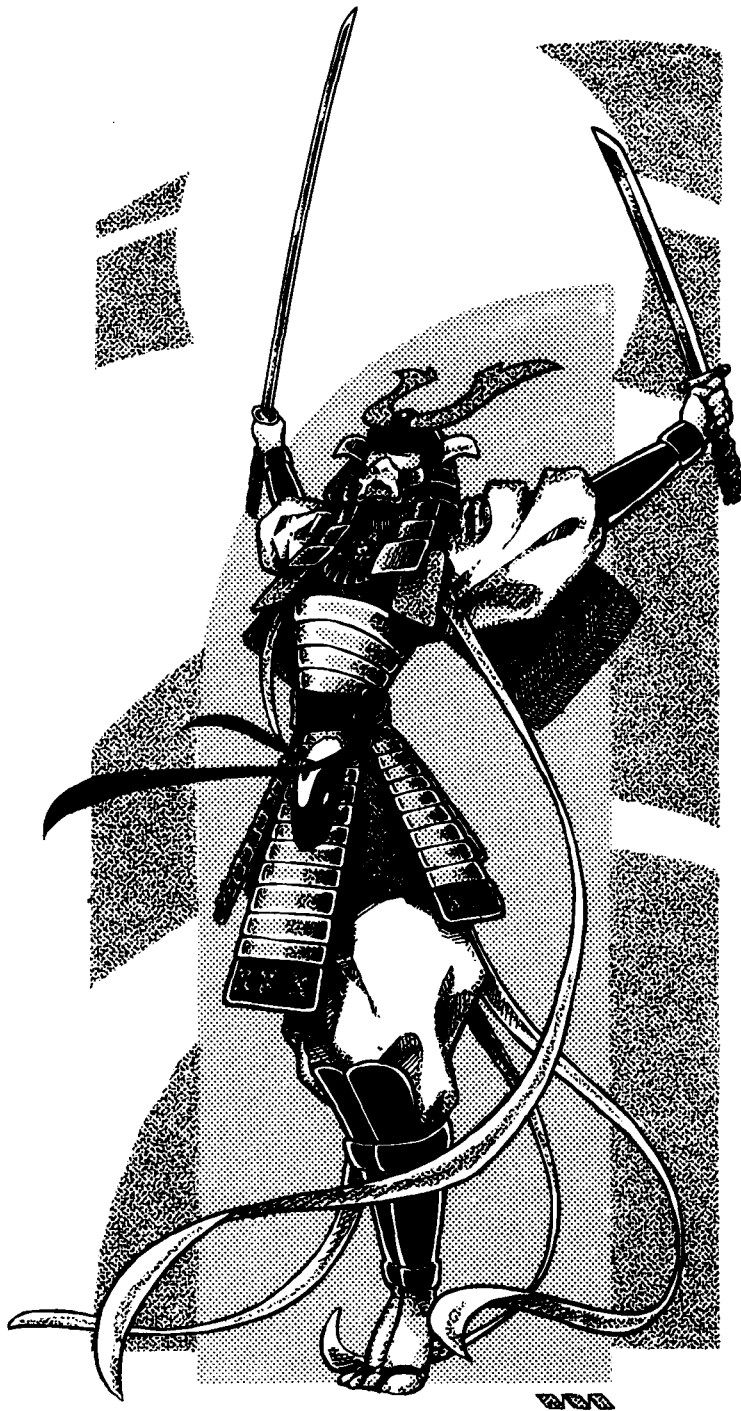

own house), has a small personal savings in gold, gems and/or other valuables worth  $3D4 \times 1000$  credits, and draws a monthly "wage" provided by the character's family holdings. This sum is typically  $1D4 \times 1000$  credits; in addition to booty the warrior may acquire from his battles against the oni, foreign invaders and supernatural forces. Note that 20% of all booty goes to the local daimyo/shogunate, 20% to the Empire and 20% to the family holdings, the rest is the samurai's to do with as he pleases.

**Cybernetics:** None. A "true" samurai will not get cybernetics for any reason. Only 10% will even consider getting bio-systems — most are ardent anti-technology traditionalists.

## Female Samurai

The women of samurai clans are also taught the arts of combat, although a bit different than the male warriors. They are taught *kendo* rather than *zanji shinjinken-ryo* and do not use the bow. Instead, they

are taught W.P. spear, W.P. sword, paired weapons and are allowed to carry and use the daisho.

### Special Samurai Training & Mastery:

1. Samurai Horsemanship only.
2. Daisho: Same as the male.
3. Chi Death Blow: Same as the male.
4. P.P.E. Bonus: P.E.x3 plus 1D6 per level of experience.
5. Other O.C.C. Bonuses: Same as the male. Also see Kendo bonuses.

Note: The code of Bushido, skills and all else is the same as the male.

The female usually rose to combat to defend her family, home, land-holdings, or village, or to avenge their slain husband, father, brother or other family members. Some are born warriors like their male counterparts and engage in battle to protect their lands and the New Empire, to defend the Empire and to rid Japan of the oni, supernatural monsters and foreign invaders.

## Ronin O.C.C.

Ronin are **masterless** samurai. One becomes a ronin when his master (a daimyo or shogun) is slain and the family removed from power (typically also slain). The modern reader of this book might think of the daimyo as the head of a political party. As head of the ruling party, he appoints his loyal supporters to posts as administrators and people in positions of power. When the head of that party is replaced by a new political power, the old daimyo and all of his officers and supporters (the samurai) lose their political power and their jobs. Unlike the changing of political powers, the samurai has no place to go in this caste society. The daimyo is typically slain and the masterless samurai is an outcast with no place or position in the new political regime. No one in the new regime will trust or hire the character, and are disturbed by his very presence. The people want nothing to do with this officer of the old power structure and may look down upon him.

The samurai loses everything, his position of authority and respect, his job, income, home, possessions, and, in many instances, his friends (slain). In a caste society, the displaced samurai or *ronin*, is a "living ghost" who drifts within a world that has no place for him, and which regards him as an intruder — a specter of the past. Under these circumstances, the character has three options: ritual suicide, search for a new master (more difficult than it may sound), or live and work as a "sword for hire" — mercenary.

Ronin are often disdained or feared by other samurai and nobility exactly because they are displaced warriors. The ronin has no social status in the caste society (no longer considered nobility or a heroic warrior). In many cases, the character has no surviving family, no master/sponsor (which means no job or money), and no commitment to any daimyo, shogunate, or region. Thus, the character has nothing to lose by any of his actions, other than his life. This "freedom like a ghost" (free, yet bound to earth) makes them dangerous, like a loose cannonball creating havoc and destruction wherever it lands.

A samurai may also become a ronin by leaving the service of his daimyo to venture off on a personal mission. This was usually done to avoid bringing dishonor or shame to his master (lord/daimyo), which his conduct might otherwise cause. A samurai might also forsake his daimyo when he could not, in good conscience, follow the orders of his master (seen to be an injustice, cruel or terrible), and therefore, becomes a masterless rogue. In the latter case, the samurai might even slay his old master or his henchmen. In either case, he is displaced, masterless and regarded the same.

A ronin may, or may not, have honor and live by the code of Bushido. They still carry the daisho, but either cut off the top-knot, shave their heads entirely or wear a completely different hair style.



Having lost everything,, many become destitute. A desperate man, even a one-time samurai, may become a bandit, thief or assassin, or a heartless mercenary forced to do what he can to survive. Daimyo in other provinces will hire ronin to bolster the ranks of their armies, often sending them on missions not behooving of a noble samurai (murder, sabotage, espionage, etc.; like a ninja in the night), or use them as fodder in the front lines of combat.

In the New Empire, displaced samurai are a rarity under the current, stable government. Internal power struggles are few and samurai families are friendly and cooperative toward each other. However, other feudal kingdoms like **Otomo**, **Surusa**, **Yukimura** and others have had generations of unrest and bitter power struggles. Many ronin have been produced by these kingdoms. Some of these ronin find the enemies of those who have usurped their power as enticing employers, but the majority seem to find the Freelands and The Zone as alluring places to carve out a living as mercenaries, adventurers, or even as heroes (the people in these troubled lands can use warriors like the samurai and the oni can offer rich pickings; although life may be short). Others wander the many Japanese islands or even travel to China and other lands in search of glory, wealth, or a new life. Others have become mercenaries for hire; some even stooping so low as to call the oni demon lords their masters.

**Alignments:** Any, but the majority are unprincipled, anarchist or evil — many are bitter and/or disillusioned.

**Attribute Requirements:** Same as the "true" samurai.

**O.C.C. Skills:** Same as the traditional samurai.

**O.C.C. Related Skills:** Same as the true samurai, but roughly 50% will begin to wander from the strict anti-technology sentiments of the traditional samurai and will learn tech-skills. Note that the use of technology will prevent the character from *ever* being accepted as a samurai by the New Empire and other traditionalists; thus sealing his fate as a ronin.

Select four other skills, plus select one additional skill at levels three, six, nine and twelve. At level one, the ronin also gets an additional three "background" skills (see table) as well as abilities from *samurai training and mastery*. All new skills start at level one proficiency.

Communications: Any (+5%)

Domestic: Any (+10%)

Electrical: Basic only.

Espionage: Any (+5%)

Mechanical: Basic only.

Medical: First Aid only.

Military: Any (+5%)

Physical: Any (except Acrobatics)

Pilot: Any

Pilot Related: Any

Rogue: Any

Science: Astronomy and Mathematics only.

Technical: Any (+10%)

Weapon Proficiencies: Any

Wilderness: Any (+10%)

**Secondary Skills:** Same as the traditional samurai, but roughly 50% will begin to wander from the strict anti-technology sentiments of the traditional samurai and will learn tech-skills.

Select three secondary skills from the previous list at levels two, six and ten. These are additional areas of knowledge that do not get the advantage of the bonus listed in the parentheses. All secondary skills start at the base skill level. Also, skills are limited (any, only, none) as previously indicated in the list.

**Standard Equipment:** The same basic equipment (suit of armor, daisho, bow and arrows, and a horse) as the traditional samurai. However, the ronin has no master/sponsor to replenish his supplies or to provide food or shelter. Thus, the character must beg, borrow, or steal whatever he can or become a **merc** or adventurer to get pay or a share of booty.

Those who come to accept technology can use any mega-damage body armor, energy weapons, **vibro-blades**, vehicles, and other high-tech weapons and equipment. However, the ways of the samurai die hard, and most will feel uncomfortable using a great deal of high-tech weapons and gizmos — most stick to the sword, bow and horse, using high-tech arrows, vibro-blades and body armor out of necessity.

**Money:** The character starts with nothing other than his horse, and the **weapons**, armor and clothing on his back. The ronin will have to find work or booty to acquire anything else.

**Cybernetics:** None to start. Traditionalists will avoid cybernetics, but some ronin will consider the occasional cybernetic implant, bio-system/prosthetic or bionic limb.

**Note:** Experienced samurai who become a ronin start at the same level that they left as a samurai. For example: A 5th level samurai; turned "ronin" is a 5th level ronin. Character that start out a ronin use the data here.

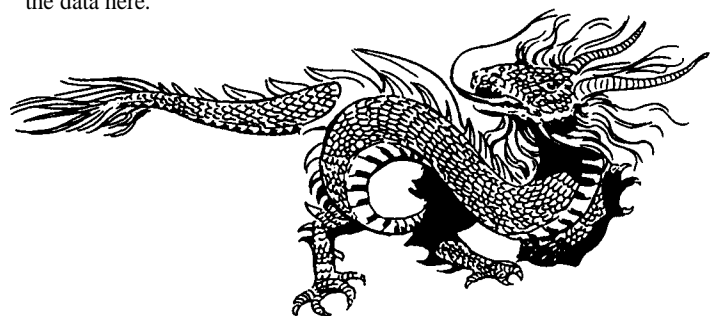

# Mystic Ninja O.C.C.

By Kevin Siembieda with additional text and suggestions by Erick Wujcik and Patrick Nowak.

In medieval Japan, before the Great Cataclysm, the ninja clans came into being as a direct response to the military society of the shogun and the samurai. Since only the samurai could carry weapons, a variety of martial arts were developed using ordinary implements, or even bare hands, to counter the samurai and his flashing swords. The warrior monks developed *jodo*, the art of fighting with a staff, others would develop karate and judo, among others.

Although the ninja would often be regarded as feared assassins, not all were evil or assassins. Originally they were simple peasants with a skill and desire for combat. Since they were not officially members of the warrior caste, they were not legally allowed to bear arms or take work as fighters. Worse, the samurai and their masters saw them as a threat — vulgar peasant warriors trying to usurp the position of true warriors. Remember, feudal Japan (which the traditionalists and New Empire emulate) was a military dictatorship. The samurai of old were responsible for keeping the peasants in line, working the fields and producing maximum yield as they were for defending the land from rival shogunates and foreigners. The peasants weren't allowed to keep weapons because they might use them to revolt or protest against their landlords, the daimyo and the samurai.

Consequently, the ninja warrior clans created a secret society and developed their own martial arts, weapons and techniques, all based on countering the might of the samurai and maintaining absolute secrecy. Thus, the ninja became masters of stealth, disguise and subterfuge. Like the ronin, they were like ghosts with no formal allegiance or ties to bind them to any one lord or region. As the secret society developed, the ninja became the ultimate warrior for hire. In most instances, the employer had no idea who he was actually employing, other than the fact that a ninja or ninja clan had agreed to fulfill a particular mission.

The ninjas skills at secrecy made them the perfect spies and assassins, for it was said they could become one with the night and that no walls could keep them out. These claims seemed very true, and while many attributed their abilities to the supernatural, in most cases it was more a matter of trickery, cunning and skill. For example, the ninja would gain access to the impenetrable walls of a castle, not through magic or by becoming one with the night, but through disguise. The pre-Rifts ninja were masters of disguise, frequently impersonating lowly peasants, monks, priests, and even samurai.

They also operated in small teams. One would catch the attention of a guard or defender, and draw him away, while one or two others would move forward to complete their task. When a samurai had one cornered, two others would leap from their hiding places to knock down or knockout the samurai and make their escape. Since all ninja dressed alike and their faces were covered, one very much looks like another.

The ninja of old also developed a number of special tools used for scaling walls, hiding underwater (breathing through a hollow reed), a way to cover their movements (smoke bombs), and used blow guns and poison tipped darts (not necessarily deadly, but always silent) and so on. Even their famous *shuriken*, throwing stars, were not designed to kill, but to distract. Throwing two or three stars at a pursuer would cause them to duck or dodge (a natural reaction), giving the ninja that precious second or two to make his escape or to hide, perhaps only inches away from his pursuers. Their clothing often had many inner pockets and concealed pouches in which to hide weapons, tools and lock picks — not unlike the modern escape artist, Harry Houdini. Like Houdini, the ninja were taught to dislocate (and pop back) their shoulders and joints in order to hide in compartments or to slip through bars and openings normally too small for a full grown man to fit. Dislocating any joint is painful no matter how skilled one is at it, so this technique was often reserved for escapes and to gain access through narrow passages



and openings. Their weapons were also small, portable and easy to conceal in any guise.

Tricks aside, the ninja clans produced deadly warriors the equal to the samurai. Most were excellent swordsmen, accomplished archers and horsemen. Thus, even in a stand-up battle, the shadow warriors were a force to be reckoned with, but it was their secrecy that evoked the greatest fear. One never knew who he was fighting and the family clans would often avenge the death or the incarceration of one of their brothers in kind.

The warriors of **Rifts Japan** are virtually unchanged, except that their intense training and deep spiritualism has given them some superhuman powers in this magic rich environment. Many regard them as supernatural agents of death.

The traditional ninja has been educated in numerous techniques which allow them to be masters of the night. They have the ability to penetrate any defense and infiltrate any fortress. Ninjutsu masters always attempt to finish their fights as quickly as possible. That can mean a devastating attack with bare hands or weapons, or just the throwing of **shuriken** to cover an escape. **Note:** The ninja only care about the mission, killing is unimportant unless it becomes absolutely necessary!

Every member of the organization must keep their identity a ninja secret. Only the *chunin*, middle-ranked ninja, will overtly reveal their identities in order to deal with customers. The *genin*, or "field ninja," are the lowest ranking members of the secret clan and will lead a normal life as a merchant, priest or farmer until summoned by their masters. In fact, many ninja have two or more false identities in the normal world, which gives them a safe haven within the community and access to local news, gossip and information. The *secretivejonin*, leader, of the ninja clan is seen only by the chunin. Frequently, when a **ninja's** identity is uncovered, or they risk capture, they will kill themselves rather than reveal any damaging information about the clan. However, being captured does not automatically mean suicide; only if his capture will cause the clan irreparable damage is it mandatory. Often the face and name beneath the mask are a false identity with no ties to the clans and which the night warrior abandons after it has been uncovered. Furthermore, the ninja have many friends and connections throughout Japan, especially among the eta, mercenaries and pirates who will give them shelter and a helping hand.

**Player Notes:** A player character may keep his occupation as a ninja concealed from other members of his adventure group by posing as some other O.C.C.; typically a monk, priest, ronin, **merc**, wilderness scout, vagabond, or peasant.

Or he may openly appear as a ninja, clad in black and face covered. This character will rarely show his face and never reveal his true identity. In fact, the character is likely to be using a false name and wearing a disguise, just in case of accidental discovery. It is also possible that the character will come to trust some or all members of the group enough to reveal to them one of his false identities in the normal world.

Also note that as a member of a *clan*, the ninja character *may* be called upon, from time to time, to serve his clan in a mission of sabotage, espionage or assassination. This "mission" may jeopardize the player group or go contrary to the group's intentions. A situation may even arise in which the ninja may have to fight one or more members of the group. To defy the edicts of the clan means, one, another ninja or a ninja team (3-6 members) will be dispatched to do the job, and two, the defiant ninja will be considered an **unreliable** rogue, a traitor, and a danger to the clan, and is marked for death. His fellow clansmen will hunt him down and silence him.

## O.C.C. Abilities & Bonuses

### Special Ninja Training & Mastery

In the times before the devastation of the Great Cataclysm, dedicated practitioners of the martial **arts flourished**. As part of their training, many martial artists learned the art of **Chi-mastery**, the ability to draw

upon cosmic energy and direct it through one's will. In the magically enriched world of Rifts, the mystic ninja can use this energy to become more than human.

**1. Mega-Damage Transformation.** Through sheer force of will and concentration, the ninja can temporarily convert his hit points and S.D.C., including those from physical skill bonuses, into M.D.C. points, transforming him into a mega-damage creature!

**Duration:** Three minutes per level of experience.

**P.P.E. Cost:** Each transformation costs the character 35 P.P.E. points. P.P.E. is restored at a rate of three per hour or six per hour through meditation.

**Healing of mega-damage** is at the same rate as non-M.D.C. natural healing — ultimately, it is the character's hit points and physical S.D.C. that is being attacked, even though they are temporarily mega-damage.

**Note:** The ninja still inflicts S.D.C. damage from his punches and kicks when transformed into a mega-damage being.

**2. The Mystic Art of Stealth:** Through his years of martial arts training, the ninja develops certain mystical martial arts powers exclusive to the ninja O.C.C. and some supernatural beings. They are known as the Art of Stealth. The character gets to select one power from this category at levels 1, 3, 6, 9, 12 and 15. See the description of **Mystic Martial Arts Powers** after the skill section.

**3. The Art of Escape or Inton-Jutsu.** This is an ability similar to that of the espionage escape artist skill. The difference is that the training is more complete, precise and disciplined. The character learns to actually dislocate the bones of his body and contort himself to slip bonds and to squeeze into openings and compartments normally too small for a human adult to fit. This training also includes muscle control (tensing and flexing muscles), knowledge of knots and ropes, and the ability to conceal tiny objects on one's body. Note that this skill does not include the ability to actually pick locks, only slip bonds that may be locked tight.

In just a few (1D4) melee rounds, the character can escape from any handcuffs, locked chains, tied rope, or plastic bonds automatically (no need for a skill roll). Slipping out of a **straightjacket** or similar restraint takes 1D4 melee rounds and a successful skill roll (roll for each attempt; the escape artist can try to slip his bonds repeatedly, but each attempt takes time and may make some noise).

This training is also extremely useful against the martial combat moves that hold, lock joints, or pin and incapacitate. Against **holds**, the character can escape in one melee action (3 seconds). Escaping from joint locks requires one full melee round (15 seconds).

Against more high-tech restraints, confinement, **and difficult** maneuvers, the character must roll under his skill proficiency, and 3D4 melee rounds are required to attempt an escape. Game Masters should display common sense when a character uses this ability. For example, even the greatest ninja is unable to escape an airtight jail cell with no openings or vents, and the lock picking skill is needed to open locks and doors. **Base Skill:** 46% +3% per level of experience.

**4. Mystic Ninja Psionics:** The mystic ninja is mentally sharp, observant and attuned to the world around him at a superhuman level. Instinctively, the ninja can "feel" the forces surrounding him.

Initial psionic abilities include: bio-regeneration (via meditation; self) and induce sleep.

The mystic ninja intuitively knows one additional psionic ability from the *physical category* for each additional level of experience and awareness, starting at level two (pick one).

At level six, the character also gets the super-psionic power of **psi-sword**.

I.S.P.: 1D4×10 plus the character's M.E. number to determine the base Inner Strength Points. As a major psionic, the character gets an additional 1D6+2 I.S.P. for each new level of experience.

## 5. The Ninja Way of the Horse and the Bow:

**Ninja Horsemanship:** Includes the ability to ride any horse-like creature at 54% +4% per level of experience. Roll under horsemanship skill whenever performing a leap or difficult riding maneuver (like riding and shooting bow and arrow). The ninja skill is the same as the samurai, whom they often impersonate.

**Ninja Bowmanship:** The mystic ninja uses the short bow which is easy to conceal. The ninja, although a skilled Bowman, loses all bonuses to strike and half their normal rate of fire when off balance or when shooting from a moving vehicle or horseback. The same penalties apply when using a samurai long bow.

**Dodge Arrow Bonus:** The ninja can try to *dodge* arrow attacks, but are -3 to dodge them and -6 to dodge energy blasts or gun fire. As usual, a dodge counts as one melee action/attack.

**Rate of Fire with a Short Bow:** Two at level one, +1 at levels 2, 4, 6, 8, 10, 12, and 14! Half for a long bow.

**Effective Range with Short Bow:** 320 feet (97.5 m)+10 feet (3.0 m) per level of experience.

**6. False Identities:** The character will start with two false, real world identities (i.e. Hideo Nobue, the sake merchant and Niitabe Shionya, the monk). Throughout life, the character will create other false identities and aliases. For example, the player group may know him as the ronin, Hiroo Suzuki, while villagers in another province may recognize him as a nameless beggar.

**7. Other O.C.C. Bonuses:** +1 to save vs horror factor at levels 1, 2, 4, 5, 7, 9, 11 and 15 and +1 to save vs illusions. Also see ninjutsu bonuses.

**8. P.P.E.: Through Chi-mastery,** the ninja becomes a living battery of mystic energy which is used to power their special abilities. **Permanent Base P.P.E.:** 1D4x10 +P.E. attribute number, plus an additional 2D6 P.P.E. per level of experience. The **ninja's** power is derived from an inward focus through meditation and ninjutsu; as a result, they cannot draw on others, ley lines or nexus points for more P.P.E.

## Ninjutsu/Tai-Jutsu Martial Arts

The art of ninjutsu has come to be identified as the art of the Japanese assassin.

**The following techniques are known at first level:** Maintain balance, back flip, body block/tackle, body flip/throw, holds, roll with punch/fall/impact, pull punch, drop kick, kick attack (2D4 damage), knee and elbow strikes (1D6 damage), paired weapons, and the usual, strike, parry and dodge.

**Bonuses:** +2 to M.A., +1 to P.S., +1 to P.E., +1 to P.P. and +4 to Spd.

### Level:

- Two attacks per melee round to start; snap kick (1D6 damage), knife hand (2D4 damage); +2 to roll with **punch/fall/impact**, +2 on initiative, +1 parry, +2 to dodge, and +2 to pull punch. Paired Weapons: Training in the use of two weapons, one in each hand, to strike and parry simultaneously. Also see samurai hand to hand combat.
- +1 to strike, cartwheel (attack), back flip (escape), back flip (defensive), and back flip (attack).
- +One additional attack per melee and palm strike (2D4 damage).
- Leap attack, axe kick, and +2 to strike when performing any back flip or cartwheel.
- Tripping/leg hook and backward sweep kicks and +2 to damage.
- + One additional attack per melee and roundhouse kick (3D6).
- Critical Strike on the roll of a natural 18-20, or from an attack from behind; Death blow on a natural 20.
- +1 on initiative, +1 to strike and parry, +1 to roll with **punch/fall/impact** and +2 to maintain balance.

9 Death blow!

10 + One additional attack per melee and +2 to pull punch.

11 Double existing P.P.E. (inner **spirit**)!

12 +1 on initiative and +2 to roll with **punch/fall/impact**.

13 +2 to damage and +1 to disarm.

14 Jump kick, +2 to back flip/cartwheel, and +2 to damage.

15 + One additional attack per melee round.

## The Mystic Ninja O.C.C.

**Alignment:** Any

**Attribute Requirements:** I.Q. 9, M.A. 12, P.P. 14 or higher; a high P.E. and M.E. are helpful but not required.

### O.C.C. Skills:

Acrobatics (+5)

Climbing (+15%)

Disguise (+20%)

Forgery (+10%)

Imitate Voices (+14%)

Palming (+15%)

Pick Locks (10%)

Prowl (+10%)

Streetwise (+20%)

Swimming (+10%)

Language and Literate in Japanese 96%

Select two additional Languages to speak (+15%)

W.P. Chain

W.P. Sword

W.P. Small Thrown Weapons

W.P. Archery and Targeting

Hand to Hand: Ninjutsu (exclusive; no alternatives are possible)

**O.C.C. Related Skills:** Select four other skills. Plus select an additional skill at levels 3, 5, 7, 9, 11 and 15. All new skills start at level one proficiency.

Communications: Any

Domestic: Any (+10%)

Electrical: None

Espionage: Any (+10%)

Mechanical: None

Medical: Only first aid and holistic medicine

Military: Camouflage only

Physical: Any (+5% when applicable)

Pilot: Horsemanship: exotic animals, motorcycle & hover car only.

Pilot Related: None

Rogue: Any, except computer hacking (+10%).

Science: Any

Technical: Any (+10% on all language skills)

Weapon Proficiencies: Any; tend to stick with ancient types.

Wilderness: Any (+5%)

**Secondary Skills:** The mystic ninja also gets to select two secondary skills at levels 2, 5, 9 and 12. These shadow warriors adapt to their environment, so many learn a handful of tech-skills. These are additional areas of knowledge that do not get the advantage of the bonus listed in the parentheses. All secondary skills start at the base skill level. Also, skills are limited (any, only, none) as previously indicated in the list.

**Standard Equipment:** A set of regular, nondescript clothing (usually peasant or traveler garb), several simple disguises, two pairs of rubber-soled tabi boots, and a black or camouflage ninja outfit. Equipment will be kept to a minimum, usually nothing more than a utility belt, backpack, 2D4 days of rations, basic survival gear, canteen and some personal items.

Weaponry is usually ancient style and concealable in nature; starts with 12 **shuriken**, two ancient weapons of choice, and one **vibro-blade**. The character also has 1D4 Ninja Emergency Kits (see Equipment section) either on their person or stored in the vicinity.

Note: Unlike the other traditionalists, the ninja is a creature of his environment, which means he adapts. Consequently, while the mystic ninja tends to avoid most of the trappings of technology, he or she will use some of its weapons, body armor and tools, like laser scalpels, **vibro-blades**, vehicles, and some are even computer literate. However, these items must be acquired later; none to start.

**Money:** A ninja starts with a mere 2D6x100 credits in saleable items. The ninja will have to find work or booty to acquire anything else.

**Cybernetics:** None, because cybernetics interfere with psionics and magic transformation and the arts of stealth (-40% penalty with cybernetics or bionics). Only bio-systems may be considered.

## Traditional Ninja Equipment

The mystic ninja still uses many of the ancient weapons and devices that have been used by ninja clans for centuries. These items are often provided or made available for trade/purchase by the ninja clan or built by the ninja himself. Ninja equipment is not available to the general public.

**Ninja Clothing & Boots:** Available in standard black for night work, white for winter operations, and red or camouflage for outdoor infiltration during the day. Consists of jacket, pants, hand gauntlets, tabi socks, double belt, leg ties, separate leg and arm pieces, and quilted groin and body protector. Numerous pockets are designed for concealing shuriken and other ninja items. Also comes with a two-part hood. The boots come in the same colors as the clothing, lace up to the knee and have thick rubber soles for use in rough country. Cost: 250 credits.

**Ninja Emergency Kit:** This is an assortment of items that a ninja might need in case of trouble. Most ninja will keep several of these kits hidden in various places. Included in a small cloth bag would be 6 shuriken, 6 eggshell bombs, 12 caltrops, a knife, a 3 foot (0.9 m) towel, a small cooking pot, paper and pencil, matches or lighter, first-aid kit (bandages, disinfectant, small scissors, painkiller), lock picks, and a set of spare clothing. Enough rice, soybean curd and tea would be included for 7 days of tight rations. Cost: 300 credits.

**Ninja Hang Glider:** Called a *hito washi*, the glider comes disassembled in a small bundle of rods and cloth, weighing about 25 pounds (11.3 kg). When assembled, it allows the character to drop from great heights, even from an airplane, and glide to the ground or treetop. Cost: 350 credits.

**Climbing Claws:** Also called *tekagi* or *shuko*. There is usually a metal or leather band that wraps around the palm between the thumb and fingers. The inside surface has from two to six spikes that are helpful in climbing wood and stone surfaces. Adds +10% to climbing skills. Cost: 65 credits per pair. Damage: 1D4 S.D.C.

**Climbing Spikes:** These are spiked claws that are attached to the soles of the feet for climbing. Note that normal walking or running is impossible while wearing these. Add +10% to climbing skills. Cost: 45 credits per pair.

**Eggshell Bomb:** This is an eggshell filled with pepper, metal shavings and other secret substances. When tossed, it will shatter and a small cloud of blinding, irritating smoke will come out. Does no damage, but all victims must save against non-lethal poison gas (16 or higher). A failed roll means the character is temporarily blinded: -6 to strike, parry and dodge. Cost: 35 credits each; 10 foot (3.0 m) diameter of effect. Maximum throwing range is about 60 feet (18.3 m).

**Ippon-Sugi Nobori:** A special tool used ONLY for climbing trees and telephone poles. A short length of spike-studded wood with ropes attached to each end. This is used much like a lumberjack's or line-man's leather climbing belt. Add 25% to climbing skill. Cost: 50 credits.

**Kawanga:** A Ninja devised combination of rope and grapple used both for climbing and fighting. When used as a weapon, the Kawanga requires the chain weapon proficiency. Cost: 75 credits. Damage: 2D4 S.D.C.

**Rope and Chain:** Available just about anywhere, from a farming village to hardware store. Modern rope and chain, such as that found in the Republic of Japan, is usually well tested and reinforced. Cost varies according to thickness and tensile strength. **An average cost** for chain would be about 4 credits per foot (0.3 m) length and one credit per foot for rope suitable for climbing.

**Rope Ladder:** This Ninja rope ladder has loops knotted into it every two feet or so (depending on the height of the owner). There is a 3 pound (1.4 kg) weight attached to the bottom end. The top end is often tied to a grappling hook. This item is easy to use and conceal. Cost: 20 credits plus one credit per foot (0.3 m) in length.

**Tetsubishi:** Ninja caltrops come in a variety of styles. All are designed so that metal barbs will point upwards no matter how they land on the floor. Damage is rarely more than one S.D.C. point, but someone with a caltrop in their foot isn't likely to continue walking until they pull it out. Not effective against M.D.C. armor. Cost: 2 credits each.



## Ninja Gimmick Clothing

Basic, ordinary looking clothing, ranging from simple work clothes to high fashion, with special properties or *gimmicks*. Some of the most common are listed below.

**1. Concealed Body Armor (light):** The outfit has an inner or concealed mesh that gives it an A.R. of 14 and 50 S.D.C. or is made of concealed, lightweight, mega-damage material that provides 9 M.D.C. (up to 50 M.D.C. can be provided by rare and powerful magic). Average Cost: 3000 to 6000 credits (non-magical armor).

**2. Concealed Pockets:** The clothing has cleverly concealed inner pockets to hold a number of small objects (**shurikens**, eggshell bombs, hand grenades, tools, knives, etc.), as well as loops, elastic holders and



hooks to hold larger concealed weapons, equipment and booty. Large pockets can be put into bulky clothing like capes, cloaks, robes, kimono, and overcoats. Cost: 20 credits per concealed pocket. A jacket or shirt can only hold about six small pockets and six loops without looking conspicuous. Overcoats and cloaks 10 small pockets, 4 large, and as many as two dozen loops and/or hooks. Hats can have 3 to 5 small pockets depending on the style.

**3. Concealed Tools:** Tiny objects like a length of fine wire, needles, razor blades, tiny lock picking tools, as well as high-tech microchips, tracer bugs, tiny recording devices, and so on, can be inconspicuously sewn into the seams, zipper or cuffs of clothing or built into a belt buckle. Cost: 15 credits per item, typically limited to four small items per shirt or pair of trousers, 8 for an overcoat, cloak or robe.

**4. Expanding Straps and Belts:** Straps and belts on clothing can be pulled off, and additional material pulled out of a concealed seam, quadrupling the length of the material (typically around one to one and a half feet per strap/0.3 to 0.45 m). This strap or belt can be used to bind prisoners, to strangle (**garrote** style) an opponent, or to be tied together as a short length of cord (rarely exceeds 10 ft/3 m total combined

length). Cost: 15 credits per length of concealed strap. A shirt will rarely have more than two shoulder straps, an ordinary jacket typically has four (shoulder and wrists; but can have as many as 10), while a cloak or overcoat can have as many as seven without looking unusual (includes the waist belt).

**5. Fake Wounding:** Plastic or animal skin sacks filled with fake blood are placed in the outfit. Each has a small explosive designed to rupture the outer fabric and spew out the "blood" to fake battle wounds. Cost: 300 credits each.

**6. Reversible Clothing:** This outfit has been modified so that a complete change of color and appearance is available simply by turning the clothes inside out. For example: A jacket may be leather on one side, and canvas or fur on the other. Cost: Double the usual cost for that article of clothing.

**7. Shoe, Sandal or Boot Compartment:** The bottoms of sandals, shoes and boots can also have a hidden compartment or concealed tool or weapon. These items are usually worn by ninja as a disguise; they wear *tabi*, split-toed boots made of soft leather or cloth without gimmicks, to move **silently** and maintain balance). Cost: 80 credits per pair.

---

## Bishamon Fighting Monk

---

By Patrick Nowak

with additional text by Kevin Siembieda

---

With the return of the gods, demons, dragons and elemental beings, a multitude of religious orders, groups, cults, individuals and holy men claim to have spiritual insight and supernatural abilities. Such clerical orders and personalities are found throughout the islands of Japan (and China). These groups range from vile cults of oni worshippers, healers and wandering priests to a variety of Zen, Buddhist, Shinto, and Taoists orders. Among these vast and diverse groups are the *warrior monks* of Japan. There are several orders of fighting monks, most very similar, but there are two particularly noteworthy monastic orders: the *bishamon fighting monk* and the traditional shinto *sohei warrior monk*.

Of all the religious groups currently active in Rifts Japan, the bishamon are one of the most popular. According to ancient belief, there are Four Guardian deities whose duties include protecting the world from demons. Only Bishamon is remembered as one of these Guardians, the other three were forgotten in the cataclysm that followed the arrival of the Rifts. With the mass immigration of monsters and demons to the Japan of Rifts Earth, a monastic order has been founded to aid Bishamon in the fight against the supernatural invaders.

The bishamon fighting monks are similar to wandering priests or demon quellers, in the sense that they roam the countryside healing the sick and battling monstrous dimensional beings. Bishamon, and the other gods, have taught the monks special disciplines that give them special powers and fighting skills. Feats of healing, curing of disease, exorcism and banishing of demons are all examples of a bishamon's powers. In addition to these special abilities, they are also tenacious warriors trained in the ancient martial art of aikido. Their ultimate mission is to cleanse Japan of the demon hordes and dark magic.

When not engaging oni and monsters in mortal combat, the bishamon are gentle, caring people with a jovial nature. Their chosen vocation requires them to not only fight demons but also to heal the sick and bring comfort in hard times. A bishamon monk will pitch in at a farm, build or rebuild homes or temples, mend fences, donate small amounts of money, help provide food, attend to the sick, or simply cheering up the downtrodden, with stories, songs, music, dances or feats of prowess. Most always seem to have words of kindness or wisdom to enrich the lives of those around them.

Some monks have, however, developed darker personalities that are often as menacing as the monsters they fight. Horrible atrocities committed by demons and other monstrous D-Bees have the effect of hardening and changing one's personality. After seeing so much suffering

and death, numerous Bishamon monks have become callous to the suffering of human beings. They distance themselves from people in order to protect against more pain. These same monks have become relentless killing machines who live only to destroy demons and monsters. In their focused determination, they have become akin to that which they hate, ignoring the suffering around them and willingly (often callously) *sacrifice* the lives of a few innocents to destroy a demon — casualties of war.

**Characteristics of the bishamon, fighting monks:** These characters shave their heads except for a small strip in the center and back, which is grown long and worn in a pony tail (no facial hair either). When traveling or fighting, they often leave their heads exposed or wear a dish-shaped hat. Armor, typically a mega-damage leaf or bark armor, is made from the sacred tree, and worn over or underneath a brown robe (brown is also a symbol of the bishamon). A large, two-handed sword called the *daito* (4D6 damage) and *bisento* (3D6 damage) spear are familiar trademarks of these warriors.

## Special Bishamon Training & Mastery

**1. Chi-Gung — Mega-Damage Skin:** Part **Chi** (inner spirit), part physical training, part mysticism (P.P.E.), chi-gung is a body hardening exercise that results in a toughening of the skin so that blades cannot cut it, and arrows cannot pierce it! Another aspect of chi-gung is being able to do spectacular demonstrations. These involve resisting sharp blades, sword points and walking on burning shards of jagged glass without harm.

In terms of the game system, the character's skin has a natural A.R. (Armor Rating) of 18 and he has at least 100 S.D.C. points. The S.D.C. and hit points of that tough skin can be turned into a mega-damage material whenever chi-gung focus is used.

P.P.E. Cost: 1 point per every two minutes (8 melee rounds) that this power is used to have mega-damage skin.

Bonuses: +1 to P.E., +2D6 to hit points, and +90 to S.D.C. in addition to any O.C.C. and skill bonuses.

Healing: S.D.C. and hit points, even those lost as M.D.C., recover as usual.

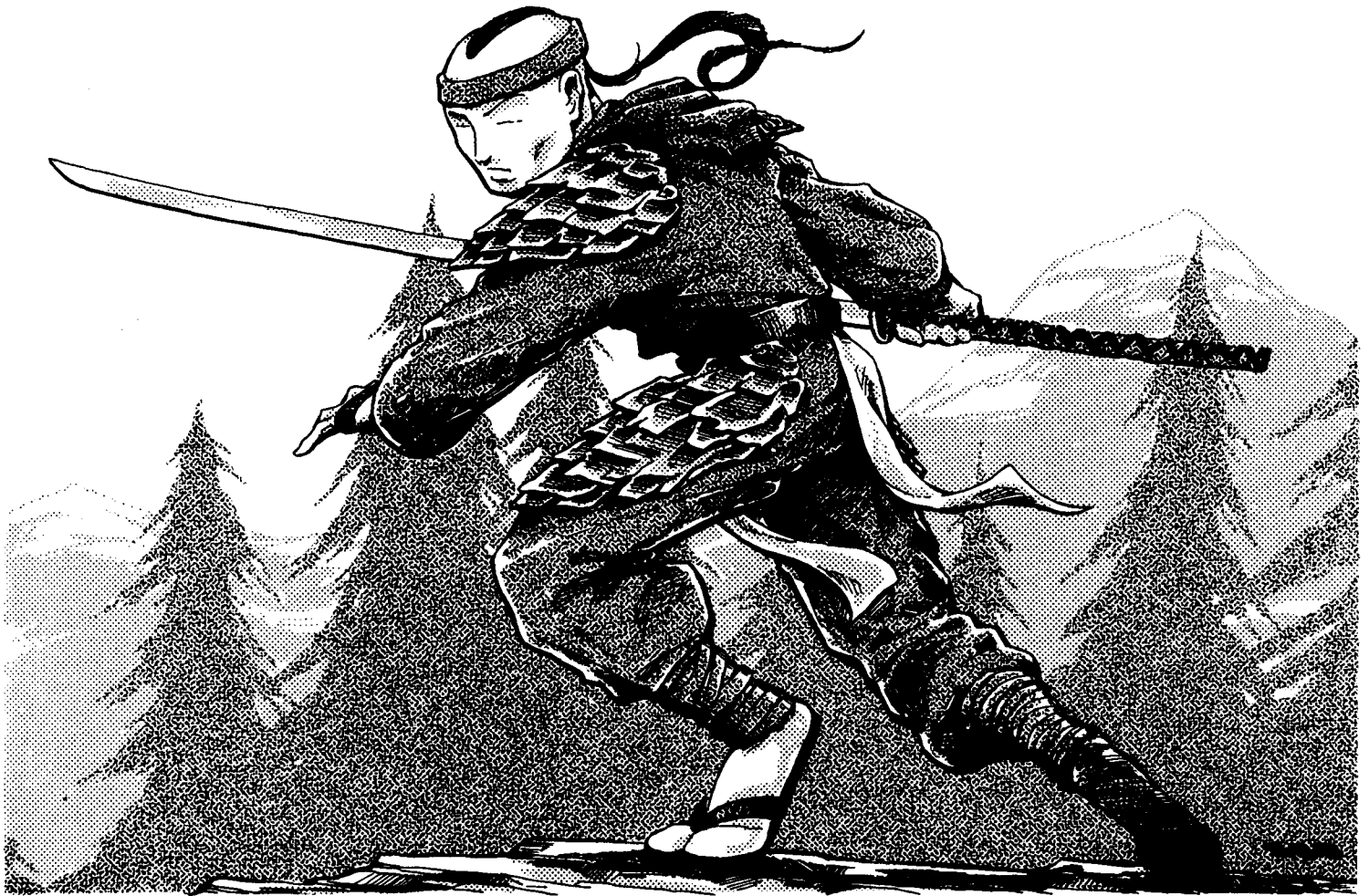

2. **Chi M.D. Death Blow (special):** A death blow that draws on the character's inner spirit with mega-damage and mystical effect against oni and other supernatural beings! Can be inflicted with punch, kick, sword, staff or spear. Same as the samurai.
3. **Mystic Martial Arts Powers:** The warrior monk develops supernatural abilities as a result of his martial arts and mystic training.
  - One additional *body hardening exercise/power* can be selected at levels 4 and 10.
  - One *mystic art of invisibility* can be selected at level three.
  - One *zenjoriki power* at level 14. See the descriptions for mystic martial arts power in the section following skills.
4. **Psionics.** Hours of daily meditation during the character's training and indoctrination process allows him/her to "tap into" the vast resources of the mind and inner will power (chi). Through this inner searching the character becomes, in effect, something between a major and master psychic.
  - At first level, fighting monks gain the following healing abilities: deaden pain, exorcism, healing touch, psychic diagnosis, psychic purification and psychic surgery.
  - At level three: Resist hunger, resist thirst and mind block.
  - At level six: See the invisible and summon inner strength.
  - At level nine: **Nightvision** and resist fatigue.
  - At level twelve: **Pyrokinesis**
  - At level fifteen: **Psi-shield**
5. **I.S.P.:** M.E. attribute number plus 2D4×10 is the base Inner Strength Points. The character gains an additional 1D6+2 I.S.P. per level of experience.

6. **P.P.E. Bonus:** P.E. x2 plus 2D6 per level of experience.
7. **Other O.C.C. Bonuses:** +1 to save vs horror factor at levels 2, 4, 8, 10, 13 and 15 and +6 to save vs possession. Also see mystic martial arts powers and aikido bonuses.
8. **Temple Philosophies & Skills:** The bishamon also gets the following special skills.
  - Begging:** Although learned as a monk, this skill can be particularly useful either as a disguise, or to collect emergency money when things are desperate. The base skill determines the chance of collecting a donation from each passerby. On a crowded street it could be pretty lucrative. The amount of money depends on the economy of the country and city where the begging is taking place. **Base Skill:** 10%+3% per level of experience.
  - Fasting:** The ability to go for long periods of time without food. So long as the character has sufficient water, two weeks without food will be pretty easy. After that, the character will have to roll under the fasting skill to avoid becoming weakened or sick. **Base Skill:** 33%+3% per level of experience.
  - Bishamon Meditation:** Involves engaging the mind and body, so that the body remains motionless, but without fatigue or pain, and the mind stays in a clear, calm and rested state. While meditating, a character recovers I.S.P., P.P.E. and other internal resources at an accelerated rate (i.e. heals twice as fast as normal). Although it is not a substitute for sleeping, characters will usually feel alert and refreshed after any period of meditation. When in a meditative state, the character is, at a subconscious level, well aware of what is happening in the environment and can instantly leave the meditation position with no combat penalties. **Base Skill:** 20% +5% per level of experience. **Base Meditation Time:** The amount of time that a character can continue to meditate:

One hour at first level, with an additional 30 minutes for each subsequent level of experience.

**Oriental Philosophies:** Characters educated in monasteries or temples can learn any one of the following: Japanese mythology, magic lore, calligraphy, haiku poetry, go, or (Zen) gardening. **Skill Bonus:** +10%

### The Bishamon Fighting Monk O.C.C.

**Alignments:** Any alignment, but typically 10% are principled, 30% scrupulous, 15% unprincipled, 25% anarchist, and 20% other.

**Attribute Minimum Requirements:** M.E. 14, P.P. 12 and P.E. 12 or higher. A high P.S. and M.A. are helpful but not a requirement.

**Racial Requirements:** Human only! They will accept other human races, but not **D-bees**, even extremely human looking ones.

#### O.C.C. Skills:

Carpentry (+10%)

Cook (+10%)

Dance (+10%)

Play Musical Instrument: Select one of choice (+10%)

Literacy: Japanese at 98%

Languages: Japanese at 98% plus two of choice (+20% each)

Lore: Demons & Monsters (+10%)

Mathematics: Basic (+10%)

Holistic Medicine (+12%)

Wilderness Survival (+10%)

Tracking (+10%; oni and humans)

Climbing (+10%)

Land Navigation (+10%)

W.P. Staff (does not include *jodo* skills and bonuses)

W.P. Sword (does not include the daisho or paired weapons)

Hand to Hand: Aikido; no other combat alternatives are allowed.

**O.C.C. Related Skills:** Select four other skills at level one and one additional skill at levels 3, 7, and 12. All new skills start at level one proficiency.

Communications: None

Domestic: Any (+10%)

Electrical: None

Espionage: Any (+5%)

Mechanical: None

Medical: Mystic Herbology (+10%; see *Rifts England*)

Military: None

Physical: Any, except acrobatics

Pilot: None; monks walk or ride in carts and vehicles.

Pilot Related: None

Rogue: Any (+6%), except computer hacking.

Science: Any

Technical: Any (+10%), except computers and photography.

Weapon Proficiencies: Any ancient only.

Wilderness: Any (+10%)

**Secondary Skills:** The character also gets to select two secondary skills at levels three, six, nine and twelve from the previous list. These are additional areas of knowledge that do not get the advantage of the bonus listed in the parentheses. All secondary skills start at the base skill level. Also, skills are limited (any, only, none) as previously indicated in the list.

**Standard Equipment:** Several changes of clothes and boots suitable for wilderness travel. Other items include a backpack, belt, sleeping roll, one large sack, 1D6 small sacks, glass or clay jars/specimen containers, 50 feet (15.2 m) of rope, cooking utensils, 3D4 days of rations and a water skin.

The warrior monk prefers to rely on his own fighting powers but does carry some weapons such as a knife, a wooden staff made from a Millennium Tree (same as the sohei monk), an ancient weapon of choice, and a mallet and 6 wooden stakes (1D6 S.D.C.)

A carrying satchel, or side pouch, will always be in the bishamon monk's possession and contains their medical supplies. This includes a variety of first-aid items, scissors, plant snippers, several types and sizes of knives, bowls of various sizes and glass or clay specimen jars. The character starts with 1D6x5 non-magical herbs. This character is always interested in healing and magic potions, teas, herbs, and ointments. **Note:** For a complete description of herbs, both magic and non-magical in nature, see *Rifts England*.

High level monks (6th or higher) who have shown great courage or self-sacrifice, may be given one of the more powerful staves from the Millennium Tree. Additional magic weapons and items may be acquired during "one's adventure through life," but the monk character starts with none.

**Money:** 4D6x100 credits in gold or **tradeable** items to start (rarely has more at any time). The bishamon is not *personally* a money-oriented character and will keep only what is needed to maintain his fight against supernatural evil and monsters. To this end, he will acquire gold, gems and valuables to purchase better weapons and equipment. The rest of the money/valuables are given to the monastic order. Goods and money may also be given to the needy, but the bishamon is less generous in this regard than the sohei and other orders — they are consumed with the task of protecting humans from monsters and ridding Japan of its demons.

Those living at monasteries have all their basic needs taken care of, and everybody in the community works to keep the place up. The character's founding monastery usually supplies them with all their basic needs: clothing, food, armor and weapons. They can also find shelter, protection, and basic supplies at any bishamon monastery. Likewise, people will often offer a bishamon fighting monk free room, sake and food because it is said their very presence frightens away demons and ghosts, or out of gratitude for his services.

**Cybernetics:** None. A monk will never agree to cybernetic implantation or bionic augmentation, even for medical reasons.

**Note:** There are no warrior females in the bishamon monastic order, they are a strictly male organization.

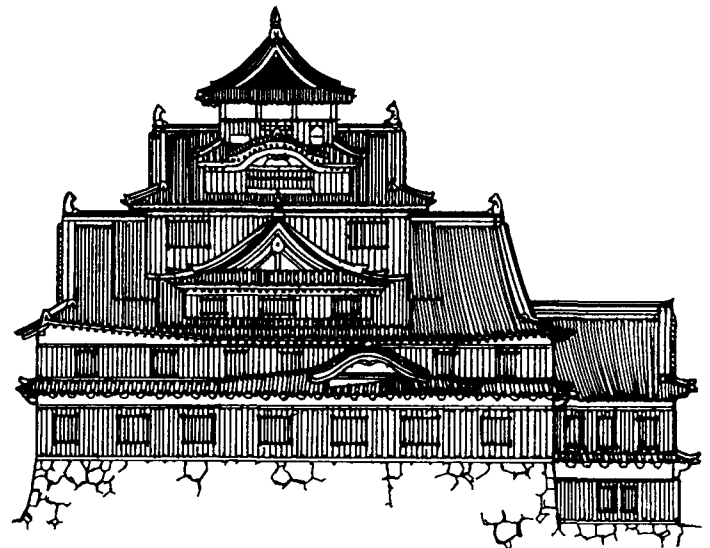

# Sohei

## Warrior Monk O.C.C.

The *sohei* is the traditional, shinto, warrior monk. Many individuals and pairs wander the land and engage in a number of academic and charitable pursuits. These loners will frequently help villagers by watching over children while the adults tend to their crops. Or the monks will offer advice to village elders or administrators, help prepare for festivals, chase away or slay **demons/oni**, help defend the people against bandits and evildoers, administer to the ill, negotiate on a villager's or farmer's behalf with their landlord (petitioning for better work conditions, food, etc.), report news and gossip, and tell stories of courage, wisdom, and the gods. These monks may also counsel samurai warriors or daimyo, or assist them in their duties, from defense of the land and demon hunting to teaching language, calligraphy, dance or poetry to nobles and their children.

During times of war, entire armies of *sohei* may join in the fight to defend a temple, village, region, or shogunate from rival factions, ravaging oni, or foreign invaders. To attack a sohei temple is pure folly, as these warrior monks have been known to easily disarm and beat experienced samurai with their tall wooden staves or deadly naginata spears (the traditional weapon of war for the *sohei*).

A typical temple will have 2D4 jodo masters (1D4+9th level; heads of the monastery), 4D6 experienced monks (1D4+5th level), 6D6 young monks (1D4+1 level), 1D4×10 new monks (all first level) and 1D6×10 novices (not even first level yet — has 1D4 years of training and practice to go). Large temples may have three times as many, while small temples will have half as many. There are at least 80 sohei temples in the New Empire alone (an estimated 400 scattered throughout the islands of Japan).

A pair of large sohei monasteries and a large **bishamon** monastery are located within a half mile (0.8 km) of the *Millennium Tree at Kyoto* (a huge Shinto temple and monastery is actually located in the tree). Both orders of warrior monks, as well as the Shinto priests, defend the city and the great "**himorogi**," sacred tree. The monks and the priests share the "gifts" of the himorogi to create weapons, armor, and holy items for the members of their order. These items are used to defend against the oni and other supernatural threats. All religious factions, plus warriors throughout the New Empire, will come and stand united in the defense of the holy city of Kyoto, its people and the himorogi.

The sohei and bishamon monks have been friendly rivals for generations, and frequently engage in antics to win the people's favor over the other (for decades the people have held both orders in equally high regard).

**Characteristics of the sohei, warrior monks:** The sohei monks completely shave their heads (including facial hair) as a sign of humility and simple strength. When traveling or fighting, they cover their heads in a knotted towel, which is often cut from the leaf of a Millennium Tree. Armor, typically a mega-damage leaf or bark armor made from the sacred tree, is worn underneath a white robe (white is also a symbol of the sohei). An outer robe or cloak of a dark color, usually brown or tan, is frequently worn over the white one to help keep it clean. Of course, the tall wooden staff and naginata spear are familiar trademarks of these fabled warriors.

## Special Sohei Training & Mastery

**1. Jodo, The Way of the Staff:** The art of fighting with a staff was originally developed as an anti-samurai martial combat form. In ancient Japan, only the samurai were allowed to carry swords, bow and arrow and other weapons. As a result, the use of the "harmless" wooden staff (and alternately, the spear) was turned into a martial art — the staff is not considered a weapon and can be used by any



class of person. The monks' devotion to the land and their amazing skills have garnered them the right to also use spears and polearms.

**Jodo Strike:** A powerful thrust with the point of the staff, or blunt end of a spear, to the side of the temple. The blow is so painful and jarring that it inflicts an extra 1D6 damage and, for a moment, everything goes black: the victim of the jodo strike loses initiative, loses one melee action and there is a 01-50% chance that he will drop whatever weapon he was holding (only drops one weapon if using paired weapons — victim's choice of which).

The sohei monk must focus and deliberately aim at and strike the temple (the player should announce his intentions before he rolls to strike). A roll of 18 or higher (including bonuses) is necessary to have full effect. Any roll that hits his opponent, but is under an 18 hits, but misses its mark and only inflicts normal damage.

**Parry Arrows with Staff or Spear (naginata):** The monk can attempt to parry arrow attacks! He is -2 to parry arrows, darts, or thrown objects, and -6 to parry gunfire. The character can only attempt to parry the projectile attacks of one opponent at a time.

+2 at level three, and +1 at levels 4, 6, 9, 12, and 15!

**Jodo Bonuses:** One extra attack per melee round when using a staff or spear of any kind (the naginata is the traditional and favorite spear of the sohei), and +1 to parry in addition to jujitsu and possible attribute bonuses.

**Millennium Tree Staff:** Most sohei (90%) are given a magic staff made from the wood of a Millennium Tree. This weapon is called the Staff of Defense. It has 2D4×100 M.D.C., regenerates all lost M.D.C. within 24 hours, possesses 2D4×10 P.P.E. that can be syphoned and used by its owner and inflicts 2D6 S.D.C. against mortal opponents or 3D6 M.D. against supernatural beings.

Other magic staves or spears may be used in the alternative.

**2. Chi M.D. Death Blow (special):** A death blow that draws on the character's inner spirit with mega-damage and mystical effect against oni and other supernatural beings! Can be inflicted with punch, kick, staff or spear. Same as the samurai.

**3. Mystic Martial Arts Powers:** The warrior monk develops supernatural abilities as a result of his martial arts and mystic training.

One *body hardening exercise/power* can be selected at levels 1, 5 and 9, plus one *zenjoriki power* at level 14. See the descriptions for mystic martial arts powers in the section following skills.

**4. P.P.E. Bonus:** P.E x3 plus 1D6 per level of experience.

**5. Other O.C.C. Bonuses:** +1 to save vs horror factor at levels 2, 4, 7, 9, 11, 13 and 15 and +3 to save vs possession. Also see mystic martial arts powers and jujitsu bonuses.

**6. Temple Philosophies & Skills:** The sohei also gets the following special skills.

**Begging:** Although learned as a monk, this skill can be particularly useful either as a disguise, or to collect emergency money when things are desperate. The base skill determines the chance of collecting a donation from each passerby. On a crowded street it could be pretty lucrative. The amount of money depends on the economy of the country and city where the begging is taking place. **Base Skill:** 20%+3% per level of experience.

**Fasting:** The ability to go for long periods of time without food. So long as the character has sufficient water, two weeks without food will be pretty easy. After that, the character will have to roll under the fasting skill to avoid becoming weakened or sick. **Base Skill:** 40%+3% per level of experience.

**Feng Shui or Geomancy:** This skill allows the character to evaluate the amount of P.P.E. in any area. He can sense whether the energy is controlled by good/positive forces or evil/negative forces and whether the flow of energy is *natural* (currently untapped by others) or whether it is being controlled/channeled by others, such as when wizards draw on its energy, rituals are performed to siphon its power, Rifts are

opened, etc. The character can also sense the direction of a nexus located on that particular line of energy, whether the energy level is strong or weak, if a ley line storm is coming, and whether the energy line is connected to an open Rift. Furthermore, the character can sense when a Rift along a ley line is connected to a world dominated by demons, alien intelligences and other evil supernatural forces, including such places as *Wormwood™* and the *Nightlands*. **Base Skill:** 15%+5% per level of experience.

**Sohei Meditation:** Involves engaging the mind and body, so that the body remains motionless, but without fatigue or pain, and the mind stays in a clear, calm and rested state. While meditating a character recovers I.S.P., P.P.E. and other internal resources at an accelerated rate (three times as fast as normal). Although it is not a substitute for sleeping, characters will usually feel alert and refreshed after any period of meditation. When in a meditative state, the character is, at a subconscious level, well aware of what is happening in the environment and can instantly leave the meditation position with no combat penalties. **Base Skill:** 20% +6% per level of experience. **Base Meditation Time:** The amount of time that a character can continue to meditate: one hour at first level, plus one additional hour per level of experience.

**Oriental Philosophies:** Characters educated in monasteries or temples can learn any one of the following: demon & monster lore, magic lore, haiku poetry, go, or (Zen) gardening. **Skill Bonus:** +15%

## The Sohei, Warrior Monk O.C.C.

**Alignments:** Any alignment, but typically 20% are principled, 25% scrupulous, 15% anarchist, 15% aberrant, and 25% other.

**Attribute Minimum Requirements:** P.P. 11 and P.E. 11 or higher. A high P.S., M.E. and M.A. are helpful but not a requirement.

**Racial Requirements:** None; the sohei will accept any "willing spirit."

For this reason, some temples are associated with dragons or the minions of Shinto gods, like the tengu.

### O.C.C. Skills:

Climbing (+5%)

Calligraphy (+10%)

Wilderness Survival (+10%)

Land Navigation (+10%)

Japanese Mythology (+15%)

Magic Lore (+10%)

Literacy: Japanese at 98%

Languages: Japanese at 98% plus two of choice (+15% each)

Mathematics: Basic (+20%)

W.P. Staff (in addition to *jodo* abilities and bonuses)

W.P. Spear

Hand to Hand: Jujitsu

Hand to Hand: Jujitsu can be changed to teng-jutsu at the cost of three "other" skill selections; no other combat alternatives are allowed.

**O.C.C. Related Skills:** Select five other skills, plus select one additional skill at levels two, five, nine and twelve. All new skills start at level one proficiency.

Communications: None

Domestic: Any (+10%)

Electrical: None

Espionage: None

Mechanical: None

Medical: First aid or holistic medicine only.

Military: None

Physical: Any; except acrobatics and boxing,

Pilot: None; not even horsemanship; monks walk or ride in a cart.

Pilot Related: None

Rogue: Only streetwise (+8%) and concealment (+6%).

Science: Any (+5%).

Technical: Any (+10% to language skills)

Weapon Proficiencies: Blunt, knife, and forked only.

Wilderness: Any (+5%)

**Secondary Skills:** The character also gets to select three secondary skills from the previous list at level one, and two additional skills at levels four, eight and twelve. These are additional areas of knowledge that do not get the advantage of the bonus listed in the parentheses. All secondary skills start at the base skill level. Also, skills are limited (any, only, none) as previously indicated in the list.

**Standard Equipment:** A suit of magic, mega-damage body armor (worn under the monk's robes), typically Millennium Tree leaf armor with 60 M.D.C.; but is not an environmental suit. When a monk reaches 6th level, a suit of mega-damage bark armor (120 M.D.C.) is presented to him by his monastery. Other types of armor, created by high level monks or priests, sorcerers, or minions of the gods, may also be acquired with time, experience and good fortune.

Other gear is minimal, a pair of white robes, a pair of light brown robes, a couple of towels to wrap the head, sandals or tabi, a rope, backpack, three small sacks, a large water skin, 4D4 days of rations.

Weapons include a naginata spear, knife, and the staff made from a Millennium Tree. The **sohei** tends to avoid other types of weapons, content with his or her mastery of the staff. Higher level monks (6th or higher) who have shown great courage or self-sacrifice, may be given one of the more powerful staves from the Millennium Tree. Additional magic weapons and items may be acquired **during** "one's adventure through life," but the monk character starts with none.

**Money:** Sohei monks don't tend to acquire great wealth. The character starts with 3D4x10 credits worth of gold or other **tradeable** items. Those living at monasteries have all their basic needs taken care of, and everybody in the community works to keep the place up. The characters' founding monastery usually supplies them with all their basic needs: clothing, food, and staffs.

Travelling monks can *always* find shelter, food, drinking water, a new robe or sandals, and basic facilities (a well, bathing area, a place to wash clothes, a place to sleep, library, and so on) at any sohei monastery. Likewise, farmers and villagers will usually offer the monk similar hospitality. In both cases, payment is a small donation or generally help, like cleaning, stacking boxes, tending the garden, etc.

If the monk has performed some special service for an individual or community, especially defending them against danger, he is usually given some small amount of money (occasionally a large amount, but most communities are very poor) and free food and lodgings.

Some sohei monks live lavishly and have a weakness for alcohol and books, but most live quiet, modest lives, giving much of their earnings to the less fortunate and their monastic order.

**Cybernetics:** None. A "true" shinto monk will never consider getting cybernetics for any reason! Only 3% will even consider getting biosystems — most are ardent anti-technology traditionalists.

## Female Sohei — Warrior Nuns

**Women can also join sohei monasteries**, but they aren't called monks, they are "nuns." They are taught all the same martial arts as the males, including jodo. Only their O.C.C. skills are a bit different.

### O.C.C. Skills:

Cook (+10%)

Sew (+10%)

Sing (+10%)

Climbing (+5%)

Calligraphy (+10%)

Wilderness Survival (+10%)

Japanese Mythology (+15%)

Holistic Medicine (+10%)

Literacy: Japanese at 98%

Languages: Japanese at 98% plus two of choice (+15% each)

Mathematics: Basic (+10%)

W.P. Staff (in addition to *jodo* abilities and bonuses)

Hand to Hand: Jujitsu

Hand to Hand: Jujitsu can be changed to teng-jutsu at the cost of three "other" skill selections; no other combat alternatives are allowed. **Note:** All related O.C.C. skills and secondary skill selections are the same as the **male's**.

The female usually rises to combat to defend her monastery, shinto temples and shrines, Millennium Trees, local community or to fight oni and evil spirits. As a rule, most nuns do not travel much, especially alone. Most spend much of their time as cooks, seamstresses, craftsmen, healers, teachers and advisors. However, there are warrior nuns born with a desire to travel, fight and seek adventure; they are uncommon, but do exist.

---

# Yamabushi

## Mountain Priest

---

The word *yamabushi* literally means, "to lie down in the mountains." The yamabushi are priests who follow the *Shugendo* religion which venerates mountains and stone formations as sacred and/or mystical places. The yamabushi believe the mountains are the home of humble and powerful *kami* — spirits and gods. By climbing mountain peaks and performing special ceremonies, the yamabushi acquires magical and supernatural powers or enlightenment. In fact, they actually draw physical and mystical strength and abilities from mountains, rock formations, large beautiful trees, and places of natural beauty.

The religion is loosely based on Buddhism and the idea that through secret ritual, one could become a buddha in life. During life, one must pass through 10 successive states of awareness symbolizing the movement from Hell to the perfection of Buddha. Rituals include fasting from drinking water,  **sutra** recitation, meditation, fire ceremonies, and hanging from cliffs to confess all sins.

Unlike the **bishamon** fighting monks, the yamabushi is *not* a demon hunter, nor an especially skilled martial artist. Rather, they are extremely spiritual and close to nature in a way vaguely reminiscent to western **druids**. Also unlike monks and priests, the yamabushi have no monasteries or flashy temples. To them, ancient trees, fields of flowers, hills, natural rock formations, giant boulders and the mountains are nature's temples. To identify some of these "holy places" for "those who have eyes but cannot see," the yamabushi will tie or hang a symbolic length of rope with knots or tassels (shinto have similar ritual rope) on, around or in front of the living object. This denotes to ordinary people a place, rock, or tree deemed to be special or holy in some way.

The mountain priests are men of peace who often travel alone to the lowlands to help the common people, especially farmers and laborers, in the way of healing, counselling, teaching, defending against supernatural evil, and may even help work the fields and deliver human and animal babies. They are also known to join small groups of adventurers and warriors to see where the "wind carries them," or on some quest whispered to them by the mountains' kami (spirits or gods). Some people, including some samurai and nobility, look upon the rough and tumble mountain priests as unwashed and uncouth free spirits who talk to the ground and regard boulders as long lost brothers. They are particularly disapproving and suspicious of the fact the yamabushi accept D-

bees among their clergy. Worse, the priests associate with tengu, goblins, faerie folk, kirin, **chiang-ku** dragons and other denizens of the mountains — and are said to share the secrets of the mountains with them. They also talk to the oni, ghosts and **elementals**, and often try to negotiate with them like rational men (which they are not) and cut deals (some would suggest pacts; which is untrue) to keep the peace in mountain communities.

It is true that the **yamabushi** show genuine respect and compassion for all life forms, particularly the eta, and D-bees — all of whom are generally treated like second-class citizens, or worse, by humans and oni alike. It is also true that the mountain priests associate with nonhumans, like faeries, creatures of magic, and even demons, and can communicate with elementals. This has enabled many a mountain priest to avert disaster by soothing the spirit of an angry elemental or tricking oni bandits to look for easier prey elsewhere. The yamabushi frequently tries to arbitrate squabbles and feuds between angry faeries or evil mountain goblins and humans or D-bees in hopes of avoiding pointless bloodshed. They are surprisingly successful at bringing temporary peace (or cease-fires) between villagers and supernatural pranksters or misguided monsters. However, it is untrue that any yamabushi, of any race, has ever made a pact with an oni or any force of darkness.

Most lesser demons, like the oni of The One Hundred, imps and goblins fear the wily and powerful yamabushi as much as the angry samurai, **bishamon** fighting monk, or the infamous demon queller. Greater demons and powerful forces look upon the yamabushi with careful consideration. They do not fear him, but they do not underestimate him either. They know that the spirit of the mountain priest is like the wind and can never be captured or held without completely destroying it. And how does one destroy the wind? They recognize that these priests know the wilderness hiding places of their oni and evil minions, and that the priest will fight and slay the supernatural with the fury of a typhoon if they evoke his wrath. Too often, the uninformed and arrogant confuse this respect with complicity and friendship — that is their mistake.

Rarely more than a half dozen yamabushi ever live or gather in the same place. The mountains are their temples and all of Japan is their domain. Most travel constantly, never tiring of the things they find, people they meet, and the places they see. Many revisit the same people and places every season or travel a particular circuit. Others roam a particular territory.

**Characteristics of the yamabushi, mountain priests:** The yamabushi looks more like a vagabond peasant or beggar than a priest or monk. Their clothing is simple and usually covered with bits of dirt, grass stains and patched tears. The bottoms of their hooded capes or cloaks, which they have a fondness for, are usually frayed from use, with bits of weeds and plant seeds clinging to it, as well as their boots, and pant legs. Their hair is long and straight, always below the shoulders and often down to their waist. It too is often seeded with bits of dirt, grass and barbs from months of wilderness travel. If they wear armor (a rarity as their hardened bodies and special powers don't require it, and they like the freedom of movement without it), it is typically made of the sacred Millennium Tree. Weapons can be anything from a magic wand or staff to a **kusari-gama** or sickle — they have an affinity for peasant weapons.

## Special Yamabushi Powers & Mastery

The yamabushi's powers might almost be considered "mind over magic." The priest uses nature and his intense belief in nature to perform feats of magic, healing and insight. The priest insists that he draws the magic energy from the earth so he doesn't actually need to have a great deal of personal P.P.E. Presumably, he is drawing on ambient P.P.E. in the area from ley lines, other people, animals, plants and other living creatures. This would explain why the character's powers are diminished in truly lifeless wastelands (no or little life), but nobody, including the yamabushi, really understands the wilderness priest's powers. The yamabushi simply smiles, and says, "it is the living earth."

**1. The Healing Earth:** The character draws on the mountain to perform healing. However, the yamabushi and his patient must either be on a mountain or be touching the surface of a huge boulder (at least twice the size of a man). To perform the healing, the priest touches the stone with one hand, draws healing energy through it from the earth, and channels that energy through his body and into the other hand touching the person in need of healing.

The healing abilities: Stops internal bleeding from any internal ruptures, ulcers, or bleeding organs. The healing earth can also instantly stop bleeding even from the deepest wounds (which stops blood loss and continued loss of hit points/S.D.C.). **2D4** hit points or S.D.C. are also restored and the healed person does not continue to suffer or deteriorate. From this point forward, the person will heal at his normal rate without further complications.

Note: The healing earth can only be performed on others. The yamabushi can simultaneously heal one additional person for every two levels of experience.

P.P.E. Cost: 10 to heal one or more people; most of the healing energy is drawn from the earth.

Ritual Time: Two minutes of meditation.

**2. Cleansing Earth:** By taking an injured or sick person into a pool of clear water (fresh or ocean water), the yamabushi can cleanse the body of disease, poison, drugs, alcohol, magic potions, and similar impurities in the bloodstream.

The people who are healed in this fashion feel instantly refreshed and strong. Any subsequent damage or effects/penalties/duration that the character would have otherwise suffered from the disease, potion or drugs is negated. However, any damage suffered before the cleansing ritual remains. The victims of poisoning or disease are +10% to save vs **coma/death** through this ritual.

Bonuses: The yamabushi is invulnerable to possession while in or near the water and performing this ritual. He is also +10% to perform an exorcism.

Ritual Time: Six minutes.

P.P.E. Cost: 10; most of the healing energy is drawn from the earth.

Note: The cleansing ritual can only be performed on others. The yamabushi can cure/cleanse one additional person for every two levels of experience at the same time.

**3. Fire Earth:** The yamabushi can step into boiling lava without harm, or stand at the top of a volcano (dormant or active) and absorb some of its power. This makes the character impervious to all heat and fire, including mega-damage plasma bolts and magic fire spells, and the yamabushi can cast the **fire** spells: ignite fire, fuel flame, and cast fire balls all equal to a 5th level wizard.

In addition, he can "speak to the **mountain/volcano**" and make an active volcano stop rumbling and/or stop spewing smoke and lava, change the course of a lava flow (a simple request), or make a dormant volcano rumble (but not erupt). Most of Japans hundreds of mountains are volcanic, including famous Mount Fuji.

Ritual Time: One minute of meditation and a mumbling chant.

Duration of the magic: The yamabushi has his fire powers for 8 hours plus one hour per level of experience.

P.P.E. Cost: 10+1 per hour of duration; most of the healing energy is drawn from the earth.

Note: The fire earth powers can only be bestowed to the yamabushi, not others.

**4. Good Earth Above:** The yamabushi can magically "restore" himself by climbing to the top of a mountain, a mountain peak (but not the very top), the top of a giant boulder (at least twice his size), or a treetop, and hanging, naked, upside down, over the edge suspended by a rope or even his own toes. Here he is buffeted by the elements,



which helps him to merge with the earth energy and cleanse his soul. The priest can also repent his sins this way by shouting into the air and ease his conscience or dream of ways he can make amends or change his ways.

**The amount of healing/change depends on how high he is:**

Top of a mountain: Bio-regenerates 20 hit points and 20 S.D.C. per hour and purges himself of poison, drugs, disease, etc., within the first hour. Broken bones heal completely within 1D4 days, cuts leave no scars, and the character is +60% to save vs coma.

A mountain peak: Bio-regenerates 12 hit points and 12 S.D.C. per hour and purges himself of poison, drugs, disease, etc., within the first two hours. Broken bones heal completely within 1D4+3 days, cuts leave no scars and the character is +30% to save vs coma.

The top of a giant boulder or waterfall: Bio-regenerates 7 hit points and 7 S.D.C. per hour and purges himself of poison, drugs, disease, etc., within the first 1D4+2 hours. Broken bones heal completely within 2D4+2 days, cuts leave no scars and the character is +15% to save vs coma.

Treetop: Bio-regenerates 4 hit points and 4 S.D.C. per hour and purges himself of poison, drugs, disease, etc., within the first 1D4+4 hours. Broken bones heal completely within 2D4+6 days, cuts leave minor scars and the character is +10% to save vs coma.

Limitations: Must remain suspended upside down and exposed to the elements for the entire period of self-healing, whether it be hours or days. During this period, he does not eat or drink water, except for whatever might fall or blow into his mouth. However, at the end, the character is completely rested, refreshed, and energized. Although thirsty and hungry, he suffers no ill effects from his days of abstinence or exposure to the elements.

If the ritual is interrupted, i.e. the priest is called down on urgent business or is pulled away against his will, whatever hit points and S.D.C. that were restored are reduced by half and the character feels weak and sickly. Penalties include -2 on initiative, -1 (one) attack per melee round and gets none of his normal bonuses to roll with **punch/fall/impact** or break fall. These penalties remain and the priest's missing hit points/S.D.C. or ailments do not heal until he can resume and finish his ritual self-healing.

The good earth above ritual can only be used by and affect the yamabushi.

Bonuses: The yamabushi is invulnerable to possession, mind control, illusion, and the elements while in this meditative ritual state.

Ritual Time: Varies from hours to days.

P.P.E. Cost: Zero at the top of a mountain, one on a mountain peak, 2 on a boulder, 3 in a **treetop**; the character draws the revitalizing energy from the mountain and earth.

Note: The top of a Millennium Tree is the equivalent of a mountain top.

**5. Spirit Earth:** The same basic procedure as the *good earth above*, except this time the focus is on the mind and the spirit, not the body.

The yamabushi can concentrate on a problem or meditate for special knowledge and get it! This spiritual insight lasts for 24 hours per level of experience and eventually fades away. Spell knowledge is limited to calm storms, summon storms, summon fog, circle of protection (superior), close Rift, mystic portal, water to wine, wind rush, spoil food or water, purification (food and **water**), stone to flesh, repel animals, breathe without air, globe of daylight, and any *earth elemental/warlock* spell. *Equivalent spell strength* is 8th level if the ritual was performed on a mountain top, 6th level on a mountain peak, 4th level on a boulder or waterfall and 2nd level if performed from a treetop.

In the alternative, the mountain priest can receive temporary skill knowledge in areas in which he has no training, education or experi-

ence in whatsoever! This includes technological skills but not martial arts or physical skills. *Base skill proficiency* is 50% +40% if the ritual was performed on a mountain top, +20% on a mountain peak, +10% on a boulder or waterfall and +5% if from a tree top.

While in this state, the character can also commune with spirits in the area, including entities, elementals, the energy essences of certain demons and alien intelligences and astral travellers. *Chance of communing* with a general, nondescript spirit is 40% +40% if the ritual was performed on a mountain top, +20% on a mountain peak, +10% on a boulder or waterfall and +5% if from a treetop. The character is -40% to commune with a specific spirit. The spirit must be within an 80 mile (128 km) diameter to be contacted, or be looking for the priest himself.

Limitations: As many as one spell or skill per every two levels of experience can be temporarily learned in this fashion.

Spirit earth cannot be performed more than once every 30 days; except for summer and winter solstices (can be done automatically on those days/nights even if the ritual was performed only a few days earlier).

The spirit earth ritual only affects the yamabushi.

Ritual Time: 2D4 hours; half the time at the top of a mountain or Millennium Tree.

P.P.E. Cost: Half of the priest's currently available P.P.E.; must be a minimum of 20 points. P.P.E. recovers normally.

**6. Iwa-Kami or "Holy Rock":** The yamabushi can indicate that a giant rock (at least twice his size) is "holy" and call forth its magic properties. This is done by sitting on top of the rock, fasting from food and drink and locked in meditation for eight days. The priest claims to talk to the rock through meditation and coax the **kami** inside it to stop hiding and make his presence known.

If the kami agrees, the stone will work either miracles of healing or see to it that farmlands within a 10 mile (16 km) radius have bountiful crops (50% greater than normal), or, if not by farmland, that the game in the area is bountiful, making for wonderful hunting.

If a kami becomes a healing stone, its powers are the same as the *healing earth power of the Yamabushi* (#1), and will perform such miracles on children, pregnant women and people of a good alignment or good intention as often as eight times a week; quadruple that number on winter and summer solstices and 10 times that number when four or more of the planets are aligned.

Limitations: The stone must be located on a ley line. The chance of success is 42% +1% per level of the yamabushi. If the ritual is interrupted before the end of the eighth day it automatically fails.

The yamabushi can only try to coax the same rock into becoming an **iwa-kami** once every eight years.

Ritual Time: Eight full days (192 hours) without interruption (rain and weather don't interfere).

P.P.E. Cost: The priest permanently loses two P.P.E. and temporarily expends 50, which recovers normally.

**7. The Power of Stone:** By swallowing stones, the yamabushi can transform into a mega-damage being. Each stone instills 6 M.D.C. points — the character can swallow two stones for every level of experience. The M.D.C. is in addition to the **character's** hit points, S.D.C. and possible other M.D.C. points through body hardening exercises and magic.

While imbued with the power of stone, the mountain priest is impervious to **normal/natural** heat and cold or fire and ice. Mega-damage, magic fire and cold attacks do only half damage, including plasma and fusion. In addition, he can withstand the force of winds up to 70 **mph** (112.6 km; impervious to wind rush) and can lift and

carry 100 times his normal capacity! Punches and combat damage is not **mega-damage**, unless using a mega-damage attack, but damage is increased by 1D6 points.

Note: Can only be used on **himself**.

Penalties: Reduce spd by 33% and reduce attacks per melee by one. The transformation gives the priest's skin a pale grayish hue.

Duration: Five minutes per stone.

P.P.E. Cost: 10

**8. Earth's Energy: Feng Shui or Geomancy:** In the case of the **yamabushi**, this is an innate, intuitive ability rather than a skill. The character can evaluate the amount of P.P.E. in any area, sense whether the energy is controlled by good/positive forces or **evil/negative** forces, and whether the flow of energy is *natural* (currently untapped by others) or whether it is being controlled/channelled by others, such as when wizards draw on its energy, rituals are performed to siphon its power, Rifts are opened, etc.

The character can also sense the direction of a nexus located on that particular line of **energy**, whether the energy level is strong or weak, if a ley line storm is coming, whether the energy line is connected to an open Rift, whether any elementals are travelling or located along the line and whether any giant boulders, waterfalls or mountains rest on the line (and their exact location). Furthermore, the character can sense when a Rift along a ley line is connected to a world dominated by demons, alien intelligences and other evil supernatural forces, including such places as *Wormwood™* and the *Nightlands*. **Base Skill:** 40%+5% per level of experience.

Duration: Constant and automatic.

P.P.E. Cost: None; a natural and innate ability.

**9. Hojo-e:** A brief ceremony to **kami** involving a three minute chant and hand motions that push away from the chest. At the end of the chant, caged or netted birds and/or fish are magically set free (without damage to the cages or nets).

Range: 100 feet (30.5 m) +10 feet (3 m) per level of experience.

Area of effect: A 10 foot (3 m) radius per level of experience. The center is the priest's desired point of focus within his range.

Duration: Three minutes of chanting and gestures with instant results at the end.

P.P.E. Cost: 10

**10. Chi M.D. Death Blow (special):** A death blow that draws on the character's inner spirit with mega-damage and mystical effect against oni and other supernatural beings! Can be inflicted with punch, kick, staff or other hand weapons. Same as the samurai.

This is important because the yamabushi frequently meets, talks to, and negotiates with faerie folk, dragons, elementals and oni.

**11. Mystic martial arts power of Kangeiko & Shochu Geiko:** Characters with this skill can resist severe weather unprotected for a full day without ill effect. For example, a **Kangeiko-trained** character stranded in the arctic snow without winter clothing would be just fine (suffering no damage) for a full 24 hours.

Bonuses from the power: +3D6 to S.D.C., +1D6 to hit points, +1 to P.E., invulnerable to *stun* and *paralysis* attacks, and fire and cold based attacks do half damage, including magic and plasma. Impervious to the withering flesh atemi power.

**12. P.P.E. Bonus:** P.E x3 plus 1D6 per level of experience.

**13. Other O.C.C. Bonuses:** +1 to save vs horror factor at levels 1, 2, 4, 7, 9, 11, 13 and 15, +2 to roll with **punch/fall/impact**, +4 to save vs possession, +2 to save vs elemental magic, and can see and speak to all elemental beings. Also see mystic martial arts power and attribute bonuses. Note: Yamabushi cannot possess psionic powers.

**14. Temple Philosophies & Skills:** The yamabushi also gets the following special skills.

**Fasting:** The ability to go for long periods of time without food. So long as the character has sufficient water, two weeks without food will be pretty easy. After that, the character will have to roll under the fasting skill to avoid becoming weakened or sick. **Base Skill:** 56%+3% per level of experience.

**Yamabushi Meditation:** Involves engaging the mind and body, so that the body remains motionless, but without fatigue or pain, and the mind stays in a clear, calm and rested state. While meditating, a character recovers I.S.P., P.P.E. and other internal resources at an accelerated rate (three times as fast as normal). Although it is not a substitute for sleeping, characters will usually feel alert and refreshed after any period of meditation. When in a meditative state, the character is, at a subconscious level, well aware of what is happening in the environment and can instantly leave the meditation position with no combat penalties.

**Base Skill:** 30% +5% per level of experience. **Base Meditation Time:** The amount of time that a character can continue to meditate: 24 hours at first level, plus 24 additional hours per level of experience.

**Oriental Philosophies:** Not applicable.

## Yamabushi, Mountain Priest O.C.C.

**Note:** Can be male or female; no difference between the two genders.

**Alignments:** Any alignment, but typically 35% scrupulous, 25% unprincipled, and 40% other.

**Attribute Minimum Requirements:** None, except a willingness to listen to the mountains and earth and accept their words. A high P.E., M.E. and M.A. are extremely helpful but not a requirement.

**Racial Requirements:** None; the yamabushi will accept any "willing spirit." Many D-bees become mountain priests (about 35%).

### O.C.C. Skills:

Acrobatics (+5%)

Climbing (+10%)

Cook (+10%)

Sew (+5%)

Swim (+10%)

Wilderness Survival (+20%)

Land Navigation (+20%)

Identify Plants & Fruits (+15%)

Japanese Mythology (+5%)

Magic Lore (+10%)

Literacy: Japanese at 98%

Languages: Japanese at 98% plus two of choice (+15% each)

Mathematics: Basic (+10%)

W.P. Staff (no *jodo*abilities)

W.P. of choice

Hand to Hand: Basic Martial Arts/Judo

Hand to hand: basic can be changed to *teng-jutsu* at the cost of three "other" skill selections; no other combat alternatives are allowed.

**O.C.C. Related Skills:** Select four other skills, plus select one additional skill at levels two, four, eight and twelve.

Communications: None

Domestic: Any (+10%)

Electrical: None

Espionage: None

Mechanical: None

Medical: First aid or holistic medicine only (+10%).

Military: None

Physical: Any, except wrestling and boxing.

Pilot: None; not even horsemanship; priests walk or ride in a cart.

Pilot Related: None

Rogue: Only streetwise (+8%) and concealment (+6%).

Science: Any (+5%).

Technical: Any (+10% to language skills)

Weapon Proficiencies: Any ancient types, including sword.

Wilderness: Any (+5%)

**Secondary Skills:** The character also gets to select two secondary skills from the previous list at levels one, four, eight and twelve. These are additional areas of knowledge that do not get the advantage of the bonus listed in the parentheses. All secondary skills start at the base skill level. Also, skills are limited (any, only, none) as previously indicated in the list.

**Standard Equipment:** Traveling clothes, a hooded cape or a cloak, typically no armor to start with. Boots as well as sandals, a 12 foot (3.6 m) and 30 foot (9 m) length of rope/cord, a small pouch filled with 20 to 30 small stones, two medium sacks, four small sacks, backpack, a large water skin, and 2D4 days of rations.

Weapons and tools include a skinning knife, a butcher knife, a small combat knife, frying pan, grappling hook and cord for climbing, small mallet and six wood or iron stakes (for climbing), a small hand axe (for chopping wood and climbing), wood or iron staff, and a weapon of choice (reflective of W.P.).

**Money:** The *yamabushi* has little need for money because they are skilled at living off the wilderness. However, they have a fascination for gems and magic, but rarely acquire a fortune.

Wilderness folk usually recognize and welcome a mountain priest into their communities and homes. They will offer him food, a bed to sleep in, and basic supplies as a courtesy. However, the larger, more sophisticated and civilized villages and cities will only see a wandering vagabond and avoid offering any acts of charity.

**Cybernetics:** None. A *yamabushi* will never consider getting cybernetics for any reason! It interferes with magic and is not natural. Although most avoid technology 15% might consider getting bio-systems.

---

## Demon Queller O.C.C.

---

The demon queller is a truly unique character. He is taught the martial arts, body hardening exercises, and demon lore in a monastery (70% are located in China), but he is not a monk or a priest. The character can cast magic spells, yet he has little interest in the pursuits of magic, except as they might apply to ridding the world of demons and all manner of supernatural horrors. The demon queller is a fabulous warrior, yet he is neither soldier nor mercenary. He calls no man master, and owes no allegiance to any one nation. The warrior's one, consuming goal is to free the world from **demons!**

When fighting demons/oni and supernatural evil, the demon queller is relentless and merciless. There is no compromise in the hearts of these warriors, unless it is to let an enemy go in order to protect or save the lives of innocent humans or **D-bees**. The warrior's first goal may be freeing the world of demons, but his next is protecting and preserving life from the monsters, thus the rambunctious warriors will not jeopardize a single human life in their pursuit of evil. Oni often view this as a weakness and use it against the mighty warriors by holding innocent mortals, particularly women and children as hostages or as bait in a trap. Most demon quellers have a weakness for beautiful women and partying, so the oni may try to send a human female minion to woo and subtly squeeze information out of the hero, lead him into danger, or distract him from other matters.

The typical demon queller travels alone or joins forces with other heroes and demon slayers, but rarely is more than two or three seen travelling together. How many of these fierce, determined warriors exist in the world is completely unknown. It is said that even the demon quellers themselves have no idea. Thus, they keep the demons they hunt guessing and on their toes. Some rumors suggest there are only a few hundred, but most say that there are tens of thousands scattered throughout demon-ridden China, India, Korea and Japan! The stories also warn supernatural fiends that for every one demon queller who falls to them, he takes **10,000** demons with him to his grave!

Note: The demon queller originated in China, where they are most numerous and most desperately needed, but they are found throughout Asia (and perhaps the world). Over the last 200 years, D-bees have joined the ranks of these warriors and represent about 20%. Only 5% are Japanese, 65% are Chinese. Theoretically, females can become demon quellers, but nobody in Japan has ever seen one.

**Characteristics of the demon queller:** The demon quellers are generally large, muscular men and usually of *Chinese* or Japanese heritage. They have a moustache and a wild, bushy beard, wear ornate (usu-

ally silk) robes, the cap of a Chinese scholar or other hat, and large black boots. Their body hardening exercises and power enable them to fight without need of external armor. Most are loud, direct, and outspoken, but also gregarious and genuine. When not hunting and slaying demons, they love to drink, eat, dance, sing and enjoy themselves. Favorite weapons are large swords, axes and **polearms**.

## Special Demon Queller Training & Mastery

**1. Mystic Body Hardening Exercises:** The demon queller has undergone brutal martial art training to toughen his body. The character possesses the following mystical abilities; descriptions are found in the section regarding *Mystic Martial Art Powers*, after the skill section.

**Stone Ox (incredible endurance/S.D.C.)**

**Chi-Gun (M.D.C. skin)**

**Iron Hand (M.D. punches)**

**Kick Practice/Chagi (M.D. kicks)**

In addition to these powers and their bonuses, the body hardening exercises enable the character to draw on mystic energy, at a cost of 1 P.P.E. point (thanks to Chi-Gung), and transform the S.D.C. and hit points of their bodies into mega-damage! Duration of the M.D.C. transformation is two minutes (8 melee rounds), again thanks to the chi-gung power. The change is instant, a simple matter of willpower and mentally manipulating magic energy.

**Note:** All bonuses and abilities are cumulative — characters can have several abilities.

**2. Chi M.D. Death Blow (special):** A death blow that draws on the character's inner spirit with mega-damage and mystical effect against oni and other supernatural beings! Can be inflicted with punch, kick, staff or spear. Same as the samurai.

**3. Magic Spell Abilities:** The demon queller only knows the spells taught to him to fight demons and really isn't interested in learning more. At best, the character will learn one or two spells to add to his demon fighting repertoire every three levels.

Initial spells include: globe of daylight, see the invisible, sense evil, turn dead, breathe without air, impervious to fire, circle of flame, fire ball, call lightning, charismatic aura, magic net, tongues, words of truth, exorcism, banishment and protection circle: simple.



4. **Meditation:** Involves engaging the mind and body so that the body remains motionless, but without fatigue or pain, and the mind stays in a clear, calm and rested state. While meditating, a character recovers I.S.P., P.P.E. and other internal resources at an accelerated rate (three times as fast as normal). Although it is not a substitute for sleeping, characters will usually feel alert and refreshed after any period of meditation. When in a meditative state, the character is, at a subconscious level, well aware of what is happening in the environment and can instantly leave the meditation position with no combat penalties. **Base Skill:** 20% +6% per level of experience. **Base Meditation Time:** The amount of time that a character can continue to meditate: one hour at first level, plus one additional hour per level of experience.

5. **P.P.E. Bonus:** P.E x2 plus 1D4x10 and 2D6 per level of experience.

6. **Other O.C.C. Bonuses:** +1 additional attack per melee round, +1 to save vs horror factor at levels 1, 2, 4, 6, 7, 9, 11, 13 and 15, impervi-

ous to possession, impervious to the bite and mind control of vampires, and +1 to save vs mind control. The warrior has a horror factor of 15 to lesser demons and 10 to greater demons. Also see mystic martial art powers and hand to hand combat bonuses.

### Demon Queller O.C.C.

**Alignments:** Any alignment, but typically 40% scrupulous, 20% unprincipled, 20% anarchist, and 20% other.

**Attribute Minimum Requirements:** M.E. 14 and P.S. 12 or higher. A high I.Q. and P.P. are also helpful but not a requirement.

**Racial Requirements:** None; although predominately human males.

**O.C.C. Skills:**

Climbing (+5%)

Swimming

Dance (+15%)

# Tengu R.C.C.

Sing (+10%)  
Wilderness Survival (+10%)  
Land Navigation (+10%)  
Tracking (+15%; humans and demons)  
Japanese Mythology (+15%)  
Demon Lore (+20%)  
Literacy: Japanese or Chinese at 98% (pick one)  
Languages: Japanese and Chinese at 98% plus one of choice (+15%)  
Mathematics: Basic (+10%)  
W.P. Sword  
W.P. three of choice  
Hand to Hand: Kendo  
Hand to hand: kendo can be changed to jujitsu or karate at the cost of one "other" skill selection; no other combat alternatives are allowed.

**O.C.C. Related Skills:** Select three other skills, plus select one additional skill at levels two, four, eight and twelve. All new skills start at level one proficiency.

Communications: None  
Domestic: Any (+10%)  
Electrical: None  
Espionage: Any (+10%)  
Mechanical: None  
Medical: First aid or holistic medicine only.  
Military: None  
Physical: Any, except acrobatics and boxing.  
Pilot: Horsemanship only (+10%).  
Pilot Related: None  
Rogue: Any, except computer hacking.  
Science: None  
Technical: Any (+10% to language skills)  
Weapon Proficiencies: Any, including modern energy weapons.  
Wilderness: Any

**Secondary Skills:** The character also gets to select three secondary skills from the previous list at level one, and one additional skill at levels three, seven and thirteen. These are additional areas of knowledge that do not get the advantage of the bonus listed in the parentheses. All secondary skills start at the base skill level. Also, skills are limited (any, only, none) as previously indicated in the list.

**Standard Equipment:** Seldom wear armor (don't need it), but may use any traditional, magic, or modern mega-damage body armor. Several sets of clothing, silk robe, black boots, black gloves, a 30 foot (9 m) length of rope, 1D6 large sacks, 1D4 small sacks, backpack, sleeping roll, two canteens or a large water skin, and 4D4 days of rations. If the character can ride a horse, he'll have one.

Weapons include a high quality, large sword (or two), a knife, plus three weapons of choice (usually reflective of W.P. skills). Demon quellers love magic weapons, **vibro-blades** and heavy modern blasters.

**Money:** 2D6×1000 credits to start. These characters often make large amounts of money, but they also tend to spend it lavishly on weapons, silks, booze and parties. Furthermore, the character is welcome in most communities and, despite their crass behavior, are frequently the guests of noble lords, kings and emperors — the warriors love to live it up, so they'll usually accept any rewards and amenities, for themselves and their travelling companions, the wealthy have to offer. Samurai and other men of arms often resent the demon queller.

Tengu are winged mountain goblins who are effectively bird people. They are infamous tricksters who tease, criticize, mock, annoy and play practical jokes on Buddhist priests (ancient rivals of the Shintoists who are their friends) and those "who worship technology," particularly those who claim to be priests, ninja and samurai, but rely on power armor, bionics, Juicer or M.O.M. conversions and other aspects of technology. They love to get these people embroiled in brawls, arguments and outright war, and then step out of the affair and enjoy the anarchy as a spectator.

Another bit of mischief is to move (not steal) items such as valuables, artifacts, religious items, keys, weapons, etc. As a rule, the item is *moved* and placed somewhere on the victim of the prank or among his other possessions, but not at the place where he last put it, or usually keeps it. Tengu are also known to carry people away and bind them to the tops of trees or towers, toss stones into windows at night, grab and carry people on a dizzying flight (usually returning them dazed but unharmed), knock over shrines, and place small shrines, statues, religious artifacts, or favorite possessions/valuables/technology in the branches of trees or on rooftops, poles, boulders, and signposts. They may also tie shoelaces together, start fires (the hot foot is a favorite), cut purse strings, flip on the safety of a gun, and similar acts of mischief common to faerie folk. This gift for causing trouble and inciting battle has made some people regard them as *harbingers of war*. Indeed, evil tengu goblins enjoy battle and the anarchy created by war.

The winged mountain goblins also have a long animosity toward the gods and demons of China and India, particularly the *t'ien-kou*, or Celestial Dog, and *Garuda* (see *Rifts Conversion Book Two: Pantheons of the Megaverse* for more about Garuda and gods of India).

The tengu are not always mischievous. They show respect and favor to "True" samurai, mystic ninja, shinto priests, yamabushi mountain priests, monks, and, to a lesser degree, practitioners of magic and those they regard as close to nature; including **druids**, **psi-stalkers**, **simvan**, **Dog Boys** and **wolfen**. They fear demon quellers and stay out of their reach. Those of a good alignment also show kindness toward hardworking farmers, children and those unfairly persecuted or enslaved. However, any of these people can feel the barbed tongue or practical jokes of the tengu if the winged mountain goblin finds them too arrogant, self-righteous, hypocritical or cruel.

Tengu of a good, and sometimes even anarchist or aberrant alignment, frequently try to protect mortals, especially humans, and other good beings from their evil brethren and demons. Many serve as the protectors of Shinto temples and monasteries, and rush to the aid of the priests or monks who live there. They will also help the priests in other small ways, like leaving them food, wine, chopped firewood, herbs, candles, incense, mirrors, and other simple valuables as anonymous gifts. The more outward helpers may openly instruct the priest in religious ceremonies or engage in philosophical discussions, play a musical instrument (drums and flute are favorites), help search for lost children, provide information and offer warnings of danger.

The tengu are especially friendly toward yamabushi. Even evil and mischievous pranksters respect these mountain priests and will listen to the things they have to say. Furthermore, they rarely play tricks on them and many will join the yamabushi in hours of conversation, music and dance, and short journeys. Many a tengu has come to a yamabushi's defense or helped him escape from villainous oni or bandits. Occasionally, a tengu and yamabushi become such good friends that the two are constant travelling companions.

Although the tengu are usually cavalier, impetuous, impertinent and spontaneous characters with a strong sense of humor (toward themselves as well as others), and despite their penchant for jokes and teasing, they can also be very serious and knowledgeable. For example, all tengu know some form of martial arts and weapon skills, along with a



WOW

knowledge and appreciation for magic, art, religious doctrine and philosophy.

Tengu of an evil or anarchist nature are more likely to harass and disturb anybody they feel like bothering and play pranks on others for their own amusement. Many villagers visited by such foul mountain goblins will leave them an offering of *kuhin-mochi*, skewered rice balls covered with bean paste, or cakes, or bottles of sake or plum wine, so the tengu won't play tricks on them. The worst of these strange villains will engage in robbery, cruel or deadly tricks, and even kidnap, enslave or torture children, as well capture and torment lone travelers (especially priests), set shrines and temples on fire, and work with other evil forces — especially those engaged in activities that will incite war and anarchy. Maleficent tengu often use their shape-changing power to disguise themselves as humans to work their vile tricks or cause trouble. They like to impersonate priests, monks, holy men and travelers in particular, but may pretend to be samurai, mercenaries or practitioners of magic as well.

**Tengu Road** is a strip along a winding mountain trail high up on *Mt. Kurama* where scores of tengu are known to live (an estimated 1000). Wingless mountain goblins, elementals, demons and other supernatural (and evil) forces also exist in this area.

**Game Master Note:** The tengu can make for a fun player character, but are also excellent and menacing Non-Player Character (NPC) villains! Evil and anarchist tengu are opportunists who often associate with bandits, assassins, mercenaries, foul sorcerers, demons, and evil forces. They will join these villains for their own gratification in causing mayhem and war, or for their own personal gain.

## Special Powers of the Tengu Winged Goblin:

**1. Shape-change into Human:** The tengu can transform themselves to appear completely human. The wings disappear and the creature looks like an Oriental person. They often elect to look like priests, monks, nuns or Buddhas (a short, round, bald male dressed in robes or silk) to trick, delude or associate with mortals. Duration: 12 hours per level of experience; can transform as often as three times per 24 hour period. Limitation: Can only appear as an Asian-looking human. Gender depends on the winged goblin's natural sex. Maximum size is 6 feet (1.8 m) tall, or 3 feet (0.9 m) small; 300 lbs (136 kg), or as little as 30 lbs (13.6 kg).

**2. Possess Others:** Tengu also have the power to possess people and speak through their mouths. This can only be done when the "spokesperson" is willing to allow the creature to do so, or when the character to be possessed is asleep, unconscious or in a meditative trance. Shinto priests and yamabushi often allow tengu to use them as a vessel to communicate.

Possessing another character enables the tengu to speak in any language known to that person, otherwise tengu speak Japanese, Faerie and Dragonese/Elf. The act of possession does NOT allow the faerie being to control the character in any other way. Duration: One minute per level of experience. Range: The tengu can be a distance of up to 50 feet (15.2 m) +5 feet (1.5 m) per level of experience.

**3. Spell Knowledge:** Globe of daylight, heavy breathing, ignite fire, fuel flame, energy disruption, wind rush, summon rain, and calm storm. Select one additional first or second level spell at levels three, six, nine, twelve and fifteen. Spells are usually elemental in nature.

These spells are automatically known to tengu as spell incantations which can be taught to practitioners of magic if the creature so desires (very rare).

4. P.P.E.: 4D4x10 to start plus 2D6 per level of experience.

**5. Tengu R.C.C. Bonuses:** +3 to save vs horror factor, +2 to save vs magic of any kind, +2 to save vs mind control of any kind, +5 to save vs possession, +4 to save vs poison, +8 to save vs disease and radiation, impervious to normal fire and heat, but magical and mega-damage fire and heat does half damage. The creature also fatigues at one-tenth the rate of humans. Also see teng-jutsu for other bonuses.

6. Teng-jutsu: Most tengu NPCs know one martial art (any except samurai and ninjitsu) in addition to Teng-jutsu; *player characters* only know Teng-jutsu.

They will *sometimes* teach martial arts to mortals whom they take a liking to (never somebody who relies on technology), including Teng-jutsu.

**Alignments:** Any; approximately 3% are principled, 12% scrupulous, 20% unprincipled, 30% are anarchist, 5% aberrant, 20% miscreant and 10% diabolic.

**Race:** Faerie folk; Japanese mountain goblin — considered a supernatural being or creature of magic.

**Attributes:** I.Q. 3D6+1, M.E. 2D6+14, M.A. 2D6+10, P.S. 3D6+12, P.P. 2D6+12, P.E. 2D6+12, P.B. 2D6, Spd 3D6+20 running, or 1D4x10+48 (40 mph/64 km to 60 mph/96 km) flying.

**Size:** 4 to 5 feet (1.2 to 1.5m) as tengu, but up to 6 feet (1.8 m) when in human guise.

Weight: 120 to 180 pounds (54 to 82 kg)

**M.D.C. (natural):** 3D4x10 M.D. +P.E. attribute number and 2D6 per level of experience.

**Hit Points:** Mega-damage creatures.

**Horror Factor:** 10

**Average Life Span:** Up to 800 years; seldom appear to age.

**Natural Abilities:** Nightvision 500 feet (152 m), see the invisible, sense supernatural beings 80% (20 foot/6 m range), fire resistant (half damage), and bio-regenerates 3D6 M.D. per hour.

**Psionics:** None.

**Magic:** See special abilities.

**Combat Skills:** All tengu receive extensive and rigorous training from an early age in the art of Teng-jutsu. This instruction combined with natural abilities makes them deadly and tricky fighters. Non-player characters (NPCs) of sixth level or higher may know a second, human/mortal style of martial arts combat, without the special mystic powers that usually accompany it. This combat ability will be equal to half the character's experience level.

### Damage:

Beak Strike/Peck/Bite or Head butt — 2D4 S.D.C.

Restrained Punch or Kick — 4D6 S.D.C. +P.S. bonus

Full Strength Punch — 1D4 M.D.

Full Strength Kick — 1D6 M.D.

Power Punch — 2D6 M.D. (counts as two attacks)

Power Kick - 4D6 M.D. (counts as two attacks)

**Average Experience Level for NPCs:** 2D4

### R.C.C. Skills:

Go (+15%)

Concealment (+20%)

Palming (+10%)

Imitate Voice (+8%)

Intelligence (+10%)

Land Navigation (+10%)

Language: Speaks Faerie, traditional Japanese and Dragonese 98%

Literate: Traditional Japanese and Dragonese/Elf(+20%)

Lore: Demons & Monsters (+10%)

Lore: Magic (+10%)

Math: Basic (+20%)

Tracking (+10% humanoids and animals)

Wilderness Survival (+10%)

W.P. Sword

W.P. Blunt

Hand to Hand: Teng-jutsu



**R.C.C. Related Skills:** Select four other skills. Plus select one additional skill at levels three, six, nine and twelve. All new skills start at level one proficiency.

Communications: Radio basic only.

Domestic: Any (+10%)

Electrical: None

Espionage: Any (+5%)

Mechanical: None

Medical: First aid or holistic medicine only

Military: None

Physical: Any, except acrobatics and gymnastics.

Pilot: None

Pilot Related: None

Rogue: Any (+10%)

Science: Any (+5%)

Technical: Any (+10%), except computers or any tech skills.

Weapon Proficiencies: Ancient only; swords, staves and blunt are favorites.

Wilderness: Any (+10%)

**Secondary Skills:** The character also gets to select two secondary skills from the previous list at levels 1, 3, 5 and 10. These are additional areas of knowledge that do not get the advantage of the bonus listed in the parentheses. All secondary skills start at the base skill level. Also, skills are limited (any, only, none) as previously indicated in the list.

**Appearance:** Short, thin humanoids with muscular builds. They have a regular human body, but the head has large, sparkling, golden or amber eyes, bushy eyebrows, and either a large bird-like beak and mouth or an abnormally large, pointed nose. A pair of large wings sprout from behind the creature's muscular shoulders. Their skin is usually pale pink, white or blue, while the wing feathers are either a darker blue, black or dark red.

**Habitat:** Although the forested mountains of Japan considered their home, tengu are also found in the mountains of Korea, China, and India. They seldom travel beyond these regions and are completely unknown in Europe and the Americas.

**Enemies:** The Chinese Celestial Dogs, the gods and minions of China and India and most demons. Dislike technology and those who worship it or destroy nature with it.

**Allies:** The humble farmer, yamabushi, Shinto priest and those who reject technology. They are also friendly with many of the gods and spirits of the Japanese pantheons and are known to associate with dragons, great warriors, scholars and philosophers.

**Standard Equipment:** A simple robe or tunic, belt, sandals or slippers, sleeping roll, one large sack, 1D4 small sacks, a water skin, a single sword (may be an living samurai katana or wakizashi, but never both), and/or club or staff (maybe a S.D.C., M.D. or magic weapon). Tengu love magic and will acquire and use scrolls, potions, and magic weapons. The occasional renegade will use vibro-weapons and even energy weapons.

**Money:** Most have little need for valuables but are attracted to silk, precious gems, artifacts and magic items. Tengu usually do not hoard valuables but there have been notable exceptions.

**Cybernetics:** None; tengu cannot use bionics or cybernetics because of their natural healing abilities and superhuman nature.

**The following techniques are known at first level:** Break fall, roll with punch/fall/impact, maintain balance, back flip escape, back flip attack, cartwheel (attack), body block/tackle, pull punch, kick attack (2D4 damage), karate kick (2D6 damage), karate punch (2D4 damage), knees and elbow strikes (1D6 damage), and the usual, strike, parry and dodge, plus the tengu special mystic martial art powers.

#### Level

- 1 Two attacks per melee round and all special powers of this style of martial arts. Also +2 to dodge (normal), +2 to pull punch or kick, +1 to disarm, +1 to roll with **punch/fall/impact**, +3 to maintain balance, and +1 to break fall. Can perform Karate style kick, jump kick, leap kick/attack and all other types of kicks.
- 2 Drop kick, +1 on initiative, and +2 on all back flips.
- 3 +1 to strike, +1 to disarm, and +1 to leap dodge.
- 4 One additional attack per melee round.
- 5 Critical strike from all kicks (double damage) and jump kick and leap attacks.
- 6 +1 to roll with punch/fall/impact, +2 to pull punch or kick, and +1 to leap dodge.
- 7 +1 on initiative, **tripping/leg** hook and backward sweep kicks.
- 8 One additional attack per melee round.
- 9 +2 to disarm, +1 on all back flips, and +1 on cartwheel attack.
- 10 Axe kick and +1 on initiative and +1 to parry.
- 11 One additional attack per melee round.
- 12 +1 to leap dodge and +1 to disarm.
- 13 Snap kick and wheel kick.
- 14 +1 to pull punch and +1 to leap dodge.
- 15 One additional attack per melee round.

### Teng-jutsu Mystic Martial Art "Powers"

The following abilities are mastered by the student of Teng-jutsu in addition to the combat bonuses and additional attacks and moves that come with experience.

**Tengu Acrobatics:** +3 to roll with punch/fall/impact, +1 to break fall, balance 50%+4% per level of experience, climb **rope/rappel** 40% +4% per level of experience, walk tightrope 40% +4% per level of experience, plus can perform somersaults, cartwheels, handstands and back flips; all things the tengu and his students enjoy doing. The martial artist can also stand perfectly balanced on one leg for ten minutes per level of experience; includes standing on a high wire — requires concentration, and attacks, parries and dodging are not possible while perfectly balanced on one foot. Same for humans/mortals and tengu.

**Tengu Leap:** 10 feet (3 m) high into the air from a standing *still* position, +2 feet (0.6 m) per each subsequent level of experience. Leaps can be straight up, or up and away. Add 20 feet (6 m) to lengthwise leaps if done from a running start, height is unchanged. The leaping height and distance is the same for both **mortals/humans** and tengu. Also see the *tengu automatic leap dodge*. Same for humans/mortals and tengu.

**Tengu Automatic Leap Dodge:** The martial arts ability to use the leap as an automatic dodge! It can be combined with back flips, cartwheels and somersaults. +2 to leap dodge plus any P.P. bonus and additional leap dodge bonuses through Teng-jutsu training and experience. Same for mortals and tengu.

Each leaping dodge uses up one melee attack, but can be done *indefinitely* to avoid attack and damage as if it were a parry. This maneuver is designed to be strictly defensive and to frustrate one's opponent(s). A frustrated or angry opponent tends to become reckless, *will* tire himself out foolishly, and focus on his *leaping* opponent rather than what's happening around him (like being lured into a trap, or not seeing others move past him, sneaking up, etc.).

Tengu typically chide their opponents with remarks like, "What's the matter? Can't you hit a moving target?" "Is that the best you can

---

### Teng-jutsu (rare among humans/mortals)

Note: Teng-jutsu can only be learned from a tengu or a 12th level master of Teng-jutsu.

---

do?" "My, you are slow." "Oh ho, you almost got me that time." "Whoops, missed again?" "Aren't you getting tired swinging that weapon so much?" "Would you like me to stand still and fight? No, I think not." And so on.

**Tengu Timed leap:** Tengu are skilled at timing their leaps to their best advantage. This is usually done to cause an opponent to swing, miss the tengu but strike a tree, rock, building, vehicle or another opponent rushing in from behind or from the side. This is a dangerous maneuver because missed timing means the character's dodge missed and he is struck by his opponent. Only a +2 bonus for a timed leap and P.P. attribute bonuses are applicable to this maneuver. Do not use any other dodge bonuses. Same for mortals and tengu.

**Tengu Kick Attack:** Rather than punch, the character can strike with a variety of karate and kung-fu style kicks. The tengu rely heavily

on kick attacks and these kicks inflict more damage than normal kicks; add an extra 1D6 S.D.C. to kicks made by human teng-jutsu artists, but tengu inflict the equivalent in mega-damage with their kicks; S.D.C. damage only if they pull their **punch/kick**.

**Tengu Power Kick:** This is a kick in which the character summons his or her inner energy, or chi, and strikes with mega-damage strength! Humans/mortals who have mastered teng-jutsu do 2D6 M.D. but the tengu do 5D6 M.D.; in all cases, the attack counts as two melee actions/attacks.

**Tengu Power Punch:** This is a punch/chop/strike in which the character summons his or her inner energy, or chi, and strikes with mega-damage strength! Humans/mortals do 1D4 M.D. but the tengu do 2D6 M.D.; in all cases, the attack counts as two melee actions/attacks.

---

# The Republic of Japan

---

Population Breakdown: 14,820,000 total; approximately 8 million live in the city of Hiroshima, 3.56 million in Kure, 1.1 million in Iwakuni and approximately 2,160,000 live in towns and villages scattered throughout the territory claimed by the Republic of Japan.

Japanese Humans: 95.7%

Non-Japanese Humans: 1%

D-bees: 3%

Oni & Others: Less than 0.3%.

Augmentation of Population:

Practitioners of magic: 1%

Spiritualists and Priests: 3%

Psychics: 6%

Cybernetically augmented/Cyberoids/City Rats: 45%

Bionically augmented (Cyborgs): 20%

Chemically augmented (Juicers): 6%

Other human augmentation: 5%

None: 14%

## History

The events that led up to the Great Cataclysm were a series of incredible coincidences. Had even one or two things been different, even the matter of timing by only a few hours, Rifts Earth would not exist. The presence of the new Republic of Japan is also the product of cosmic coincidence.

A handful of maverick, Japanese scientists were working on dimension-spanning secret experiments with what they incredulously considered to be a new form of energy. Perhaps it is not surprising that the Japanese, with their long tradition of attributing nature with supernatural aspects, would be among the first to recognize ley line energy. Of course, this is a bit of a stretch, because Victor Lazlo and so-called "quack" spiritualists of the 20th Century had tried to tell people about ley lines and Potential Psychic Energy (P.P.E.) for decades. Furthermore, ancient Chinese geomancers and Japanese priests and mystics recognized the power of ley lines thousands of years earlier. It was only humankind's myopic pursuit of science that blinded them to other possibilities.

As fate would have it, the moment the ley lines erupted with new energy and the planets were in exact alignment, the Japanese scientists flipped the switch on an experiment to teleport, via dimensional warp, a tiny vase a distance of ten feet. Instead, the entire city of Hiroshima and

the surrounding area within a 100 mile diameter (160km; including the cities *Kure*, *Iwakuni*, and *Ichto*) was teleported into a pocket dimension!

For three days the rest of the world seemed to vanish. The scientists had no idea what they had done or how to reverse it. In truth, they may have had little to do with the phenomenon, and probably only ignited the spark that sent them into another place and time; dimensional anomalies were a large part of the Great Cataclysm. The fact of the matter is, being displaced in space and time saved an estimated 16 million lives!

The displaced people reacted surprisingly calm to the twilight limbo that surrounded them. Less than a thousand citizens were hurt through panic or foul-play. Spontaneous rioting and looting occurred only in Kure. Most people stayed home, prayed and waited. The real nightmare would begin on the fourth day, when the cities emerged from limbo and back into the real world.

What had been three days for the people in the pocket dimension had been approximately 300 years on Earth! The cities reappeared on Rifts Earth in the year 87 PA. At first the people rejoiced to be back home, alive and safe, but they quickly realized that the Japan they had left was gone forever. Within six hours of their reappearance, Hiroshima and Kure were attacked by demonic and elemental forces. 8,953 people were killed, 32,100 were injured with 1460 missing; captured and carried away by the inhuman invaders, most never to be seen again.

In the weeks that followed, anarchy reigned. This time there were riots, looting, murder, and mass destruction. In an act of despair, thousands of people committed suicide, or tried to flee the island before they realized there was no place to go. Grief stricken people left the area in search of loved ones (not realizing 300+ years had passed), and raids by inhuman monsters continued, though none as terrible as that first day. Over 280,000 people would perish or disappear and nearly half a million would suffer injuries; all within a matter of five weeks.

Political and corporate leaders, joined by the remnants of law enforcement officers, climbed to the forefront and were able to reestablish some measure of strained peace. They established a rudimentary government based on the one they had always known, and resolved to defend and rebuild the Japanese nation. So it was that the Republic of Japan was born (reborn).

The first thing on their agenda was to build an army and fortifications that could protect the cities from inhuman invaders. To this task they began to build mega-damage weapons, power armor, robots, and created bionic and chemical/Juicer augmented troops. Massive walls

and defensive barriers, manned by troopers outfitted with high-tech weapons, were quickly erected. Eventually, the cities became impregnable bastions against the pervading anarchy and horrors beyond their walls.

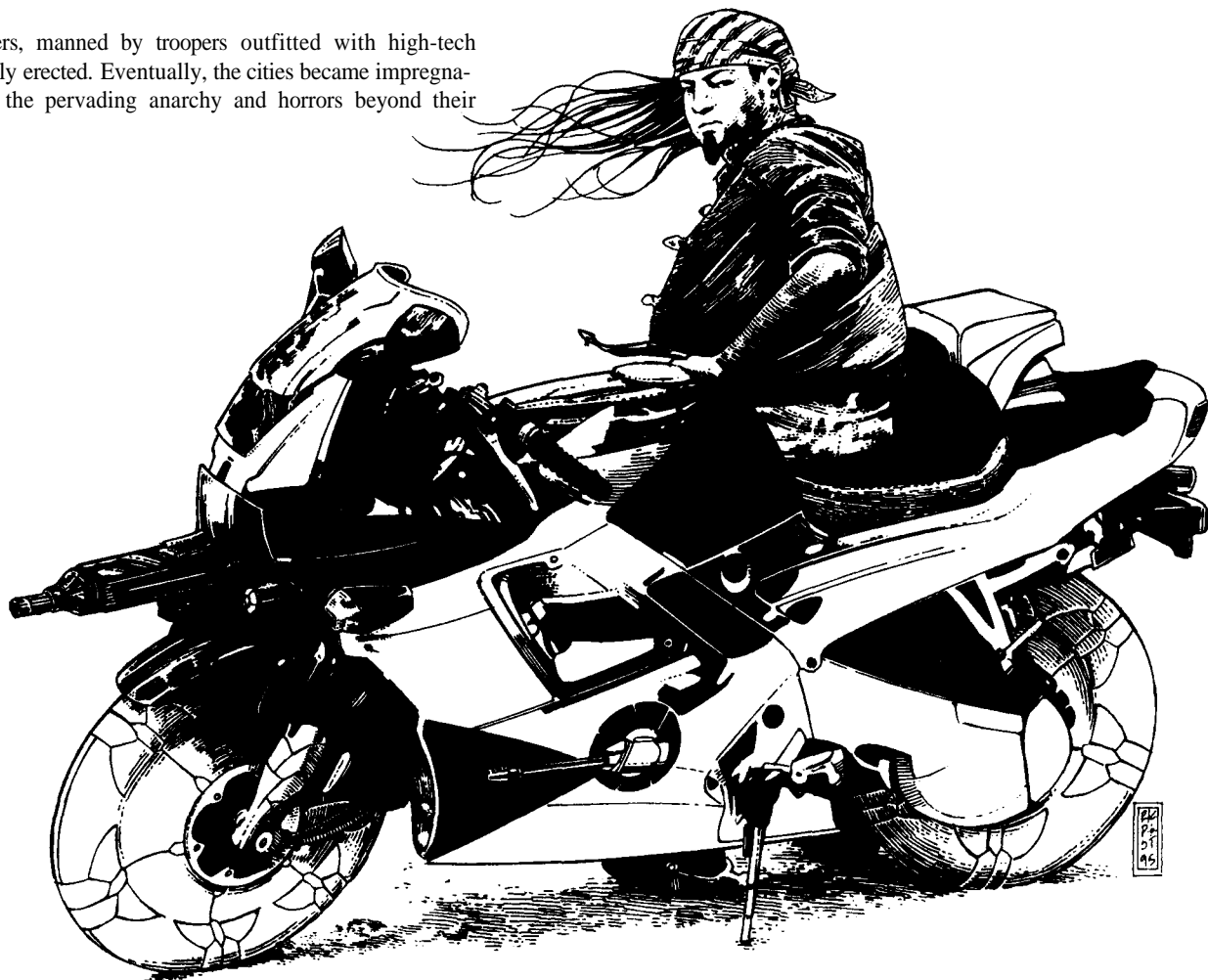

Hand in hand with this plan was the allocation of supplies, finding off-island resources (particularly raw minerals and metals), and learning more about their enemies and the immediate world around them. This involved preliminary exploration of the islands, reconnaissance flights over Korea, Taiwan and the eastern coast of China, and communication with the less monstrous inhabitants of their Japan. All of these things began to give them a good picture of what had happened, the passage of time, and the insane and alien world they had come home to.

Second was strengthening the structure of government, implementing guidelines, laws, and restrictions appropriate for their hostile environment, without dramatically diminishing the life style to which they were accustomed. This also meant an extensive educational program to teach the population about their new Japan. People had to be made to realize that magic and monsters were real, but that these menaces could be vanquished or avoided, and that magic and psychic abilities meant new avenues of human development, augmentation and scientific advancement.

After these things were accomplished, everything else has pretty much fallen into place. There have been problems and setbacks, like the splintering of *Ichto* from the Republic and the growing chasm between these two super-tech powers, as well as continuing problems and conflicts with transdimensional beings, oni ("demons"), gods, elementals, monsters, sorcerers, powerful psychics, D-bees, pirates, bandits, mercenaries, the anti-techies, in addition to the general hardships of adapting to a bizarre, isolated environment filled with alien life forms, alien technology, magic and dimensional anomalies. This restructuring and adaptation has been in progress for the last 15 years, and though most have reasonably acclimated to the world of Rifts, it continues to this day.

**The indigenous Japanese population** (ironically, their descendants) would avoid these modern cities for months, believing the inhabitants to be monsters, invading aliens, or gods. The cities

reappeared, in an area lightly inhabited by a few thousand Japanese and D-bees, all of whom perished (displaced) when the cities phased back into this time period. Some people, like those at the Otomo Shogunate, blame the Republic for the deaths of these poor souls and try to imply that the city people are not true Japanese and may indeed be inhuman monsters or shape-changers. A disturbing number of uneducated and superstitious peasants and wilderness folk believe these lies. They point to the Republic's cyberoids with their implants, cyborgs, Juicers and Crazies as evidence of their inhuman (and monstrous) nature. The New Empire and many others try to dispel such foolishness, but the rumors and fears linger among wilderness folk, especially in the Freelands.

Several months after the cities' reappearance, a large number of the local indigenous population finally began to come to the cities. When they came, they came in droves, seeking the protection and technological wonders the cities had to offer. In the devastated world of Rifts Earth, "droves" of refugees constituted less than 15,000 people, mostly peasants and farmers, easily absorbed by the cities.

With time, conflicts would develop with *Ichto* who wanted no part of the new Republic of Japan. The Otomo Shogunate would regard them as dangerous rivals, as would the inhuman denizens of The Zone, China and many of the smaller feudal kingdoms in and around the Japanese islands.

At first, the New **Empire** was fearful of the cities, but were among the first to visit in peace and recognize exactly who and what they were. The people of the New Empire now regard the Republic of Japan as the "lost children of Japan" — "lost" having more than the obvious meaning of having been displaced and recovered. To the traditionalists and sorcerers of this kingdom, the Republic represents all the things that led to the fall of Japan. They believe that technology and mankind's losing touch with nature and the supernatural is what ultimately caused the Great Cataclysm that transformed the planet. The return of people, tech-

nology and entire cities from the "Age of Folly" is regarded as a test of their resolve and commitment to their ways. Surprisingly, they do not regard the Republic of Japan as evil or with great animosity. Instead, they regard them with compassion and concern. They see the kingdom as a challenge, and believe it is their destiny to make these old technocrats forsake technology and join them in the harmony of nature and spirit.

This quest is ardently pursued through predominately peaceful discussions and occasional protests. While one might argue that the cyberoids of the Republic can never be swayed and that the Shintoists' quest is an impossible one, approximately 2% of the Republic's original population (roughly 280,000 people!) have left the cities to live a quieter, spiritual life of tradition in the New Empire or other low-tech or traditional feudal kingdoms. One percent of the current residents share the anti-technology sentiments and are active in the movement to return to tradition. To the New Empire, this is a mass exodus and a sign of their good works.

Approximately 45% of the overall population have adopted various beliefs, aspects and elements of the old traditions, Shintoism and spiritualism. For example, spiritual charms, mirrors, wards, and religious artifacts are extremely popular. Replicas of samurai swords (both S.D.C. and M.D.C.), daisho, and armor are everywhere. Traditional artwork, clothing, religious items and charms are also popular. Gardens, ancient trees, and unusual rock formations are given a special place in the city and seen as places of quiet, harmony and meditation. Many people now believe so strongly in magic and the supernatural that they have taken up mystic occupations. An estimated 1% of the population are novice practitioners of magic (1 to 3rd level), 3% spiritualists and priests, and 6% psychics; many of whom actively work to defend people from evil magic and the supernatural.

The anti-techies regard all of this as monumental strides in the conversion of the technocrats. However, while magic and the supernatural are accepted as painful and frightening *realities* by the entire population, even those who have adopted some measure of spiritualism and/or practice magic are unwilling to forsake the comforts, pleasures and toys technology has to offer. A more likely scenario for the future is a true melding of science and magic, but that is generations away from fruition.

Meanwhile, there is a strong movement, especially among some of the youth factions of *cyberoids*, to totally hate and reject traditionalism, spiritualism and magic. Like the Coalition States of North America, they accept the existence of magic and supernatural beings, but believe they only represent trouble and evil, and should be avoided and destroyed! In many regards, they are the antithesis of the anti-techies and, in some cases, are violent, attacking traditionalists, beating up practitioners of magic and priests, or vandalizing their homes and property. These militant factions of city rats tend to target "outsiders" from the New Empire who "spread their lies" through peaceful protests, conferences and discussions. With increasing frequency, these groups are causing riots and skirmishes at conferences and protest sites where anti-techies congregate. Such sentiments are pervasive in the Ichto Province and Otomo Shogunate outside of the Republic of Japan. Thankfully, such violent clashes of cultures and ideas are infrequent in the Republic and are quickly defused by the authorities. Still, approximately 26% of the Republic's population are steadfast *technocrats* who believe in the superiority of science and technology over magic, and stringently reject any movement toward tradition and spiritualism. 2% are extremists who show their displeasure through acts of violence.

# People Out of Time

The people of the Republic of Japan are people out of time. To them, the Great Cataclysm is just a terrifying story that they or their ancestors never experienced. Humankind's 300 year climb out the Dark Ages and struggle to survive are not part of their history or their reality, except in a peripheral way. For them, the Golden Age of Man was only yesterday. The race for technological supremacy and human augmentation was their reality. Consequently, their view of the world (due, in part, to ignorance) is very different than those found almost anywhere else on the planet. Despite the horrors and hardships they have faced, they are happy, free, confident and defiant. The people of the Republic look squarely into the face of supernatural enemies with defiance. Because they are so new to Rifts Earth, and because they have the super-technology to support their goals and defend themselves, they see a frightening alien world all around them and have to resolve to conquer it.

As people out of time, they have retained their old views, beliefs and laws. They have not had to rebuild from rubble, simply retool and adjust. They do not yet feel bitter or besieged, so they are more open to new ideas and new possibilities. They regard non-humans as a curiosity and cautiously welcome even the strangest creature who comes in peace. They are not foolish optimists who place blind trust in their future and fellow peace-loving beings, quite the contrary; they demand that non-humans in particular prove their loyalty; they are suspicious of strangers and advance ever so carefully into the future, but they are optimists. And this optimism gives them a strength and zeal many others have lost.

## Government

The government and society is not dramatically different from 21st Century Japan, or 20th Century Japan for that matter (only the technology is more advanced). The government is a democratic republic with a capitalistic orientation. Currency is in the form of credits based on the Japanese Yen. The basic laws and fundamental ethics and attitudes are also unchanged.

The government is amazingly efficient, free of widespread corruption and fair for most people. Much of its efforts are spent on running its cities and territories, defending them from inhuman menaces and developing the resources to remain strong and independent.

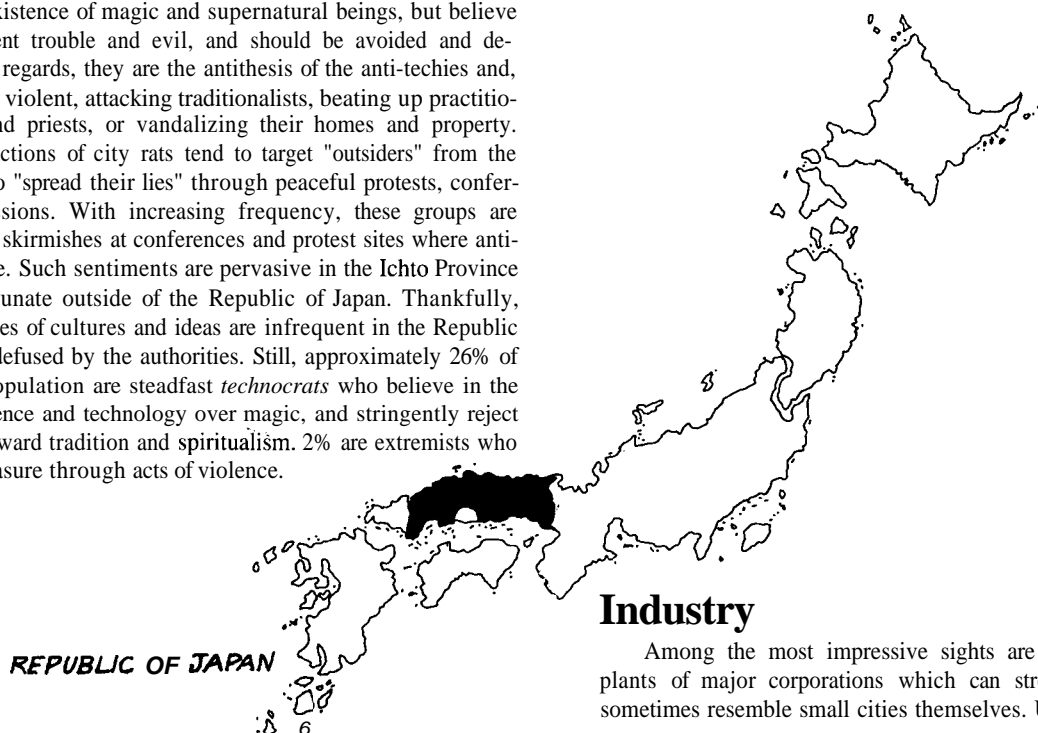

## Industry

Among the most impressive sights are the huge manufacturing plants of major corporations which can stretch for city blocks and sometimes resemble small cities themselves. Unlike the manufacturing

giant *Triax*, of the NGR, there are more than thirty major corporations in the Republic of Japan. Competition is fierce, sometimes too fierce as is evident in the detrimental behavior of the **Ichto** Robotics Corporation and **H-Brand**. **Cybercomp** has captured the communications network with a huge service department, telecommunications company, a half dozen radio stations and three television stations!

**The Kiramitsu Motor Company** is the second largest money-making corporation in the Republic (**Armatech** being number one). Each year thousands of high quality, affordable vehicles come off the factory lines in Kiramitsu plants. Dozens of different hover cars, cycles and trucks are available from Kiramitsu Motors, as well as sail and motor boats.

**Industrial espionage is a way of life!** Literally hundreds of spies, often some type of ninja, ronin, mercenary or monster, try to steal corporate secrets, sabotage research or manufacturing facilities and even assassinate key personnel. This is especially true of rival or contemptible corporations and kingdoms outside the Republic of Japan, such as Ichto Robotics Corporation and H-Brand, rival kingdoms, fanatical anti-techies and of course, the creatures from *The Zone*. For this reason, the government allows many Republic corporations to have a security force armed with mega-damage weapons and armor. Many of these security teams are a small squad or two of elite specialists composed of ex-military officers, borgs, Juicers, samurai, ninja and mystics. Some of the larger security forces are the equivalent of a small private army with as many as 640 men, a full battalion subdivided into companies, platoons and squads. Some corporate officers, politicians and public personalities are also allowed to carry M.D. weapons, use M.D. armor and/or hire bodyguards. Authorized guard and security services are a booming business.

Similarly, farmers, laborers and merchants whose work carries them away from the cities and into the wilderness or beyond the borders of the Republic, may get authorization to use mega-damage weapons, armor and equipment. Those who can't get authorization may obtain illegal means of protection from smugglers or the black market. **Note:** See the gun laws in the weapons and equipment section of this book.

Being an island, a great deal of Japan's raw materials, ores and fuels must be *acquired* from sources outside of Japan. Ocean salvage of sunken cities, outposts and mining operations in Korea and China, and raids against villages of monsters in China and Korea provide a great deal. Combined with trade with sailors/pirates, the New Empire, **Takamatsu** and other communities, fill most of the Republic's needs for raw material.

Energy needs have been taken care of by means of **geothermic** power plants, solar energy arrays (on the water), nuclear power, and imported petroleum from **Takamatsu**.

Agricultural needs are satisfied with high-tech, high-yield farmlands and supplemented by giant hydroponic gardens, synthetic food and vitamins, fishing, seaweed and algae, and a small percentage of imports.

An airport is located at Hiroshima and Kure (as well as at Ichto, Takamatsu and the Otomo Shogunate), but flying is dangerous and generally left to the military.

A fishing fleet and fledgling navy are located at Kure; otherwise bots and power armor are used for plumbing the waters and defending the coast.

## The Cities

The three major cities of the Republic are *Hiroshima*, *Kure* and *Iwakuni* — each a thriving megalopolis and home to millions. Hundreds of skyscrapers and other massive structures of mega-damage concrete, steel, ceramics, and glass, tower 20-60 stories into the sky like man-made mountains. Half of all skyscrapers are mega-damage structures (2D4x4,000 M.D.C.) and designed to survive earthquakes up to a magnitude nine on the Richter scale! Hundreds of 10-20 story buildings surround the large central area, most of which are apartment complexes and business offices. Thousands of small 2-3 story businesses and resi-

dences fill out the rest of the city. Beyond the city lights are sleepy villages and quiet farms, many of which use the latest in technology for high yield crops year round. Sprawling suburbs are a thing of the past, as most people crowd to the cities where they can get the maximum protection and feel safe.

The downtown areas are bustling with throngs of people, as are the cultural centers and central shopping areas. Neon signs, video displays, and computer terminals are everywhere. Taken for granted is the advanced communications network that can be accessed by telephone or computer, and which links the cities and the surrounding towns and villages with up to the minute television and radio transmissions. All the wonders of high-technology are at the disposal of the citizens: food, alcohol, entertainment, mass transit, television, communications systems, video recording equipment, home security systems, electronics, pocket computers, CD-players, bionics, cybernetics, hover vehicles, motorcycles, jet packs, legal augmentation and more.

All kinds of illegal items and services are also available via the black market and the criminal underworld. Body chop-shops offer cybernetics with greater "punch," special (illegal) features, or discount prices. Illegal weapon implants and bionics, Juicer augmentation and even M.O.M. (crazies) conversions are available. If one knows where to look, he can acquire drugs, women, mega-damage weapons, power armor, magic items and other articles outlawed by the government. Or find illegal gambling, **bloodsports**, drug dens, magic and freelance employment. All manner of vice, decadence and adventure can be had, if one is willing to take the risk and can afford the price.

## Education

The people are well educated and hard working. Before the Coming of the Rifts, Japan was one of the "Great Empires" as Erin Tarn or western scholars might phrase it. The Japanese people were among the most educated in the world. The typical school year was 240 days long, 88% of the population finished high school and 64% went on to pursue higher learning. Literacy, history, mathematics, language, and computer skills were all important aspects of education. This is the foundation for the Republic of Japan and this is the structure that remains in place.

Approximately 95% of the current population have some level of formal education (at least an eighth grade education) and are literate in Japanese and computers; 80% finish high school and 60% go on to higher education. Only those from the outlying farmlands and villages who joined the Republic after it returned to Earth are illiterate and know little about computers and high-technology, but they represent only 5% of the total population and many are anxious to learn.

### The Average Citizen

The average citizen is educated, literate and knowledgeable. 35% are highly skilled technicians, engineers, scientists, doctors and professionals, 30% are service oriented, 30% are part of a skilled labor force, and only 5% are unskilled and uneducated.

#### The average citizen will have the following skills:

Basic Math (+20%)	Language: American (+10%)
Computer Operations (+10%)	Literacy: Japanese (+20%)
Language: Japanese (+25%)	Literacy: American (+5%)

Note: 25% can speak, read and write Chinese, 3% Gobbly, and 2% **Dragonese/Elf** and **Faerie Speak** (in the latter two cases, these languages are studied mainly by priests, practitioners of magic and spiritualists). They have never heard of *Euro* and they may be at a bit of a loss when they begin to encounter people from the West. Fortunately, the island survivors of the Great Cataclysm still speak traditional Japanese so there's been no language barrier.

See the O.C.C. section for some specific Republic occupations. *Scholars*, *scientists*, *doctors* and *operators* (engineers) can be rolled up fundamentally the same as described in the **Rifts RPG**, except they are honored members of society, not rogues. Japanese society respects, seeks and promotes knowledge. Also see some of the new skills which are appropriate for Japanese society.



## Human Augmentation in the Republic of Japan

The Republic of Japan (and Ichto) possesses the highest level of technology on Earth! Equal to *TriaxIndustries* and, in some instances, superior!! The pre-Rifts people have mastered **nanotechnology**, super-computers, mega-damage weaponry, bionics, cybernetics, robotics, and human augmentation, all of which they bring with them to Rifts Japan.

These people are the product of **super-science** and a period of time when *human augmentation* was not only the norm, but the rage. This attitude is still pervasive in the high-tech society of the Republic of Japan. Consequently, augmentation is commonplace, accepted, and encouraged.

All types of cybernetic augmentation are legal, from cosmetic implants and attachments to bio-systems, computer jacks, optics and sen-

sors (see the section on *Cybernetics and Bionics* elsewhere in this book). Even some weapon systems are legal with government authorization and the right permits. **Cyber-weapons** can also be acquired illegally through the underworld.

20% of the population are partial or full conversion borgs, and nearly 80% have submitted themselves to some form of cybernetic enhancement, including cosmetic surgery, artificial limbs or organs, minor implants, major enhancements, and bionic reconstruction or full conversion. Others use exoskeletons, power armor, or robots to supplement their abilities. An alarming number of people even subject themselves to illegal Juicer and M.O.M. conversions or experimental genetic manipulation, even at the risk of premature death, mutilation, and/or insanity.

A full 45% of the population are **Cyberoids**—citizens the Coalition States might characterize as *city rats*. These citizens understand computers and electronics as good as most North American operators and scholars, and are "connected to cyber-space" via a multitude of cybernetic enhancements.

**Note:** See the sections on *Cybernetics & Bionics* and the sections on *Cyberoids* and *Cyborgs/Bionic O.C.C.s* for comprehensive details about bionics in Rifts Japan.

## M.O.M./Crazies & Juicer Augmentation

Juicer and crazy technology is illegal, but available through underworld connections as well as from high-tech bandits, shoguns and kingdoms that operate as independent communities.

In the past, before the Rifts, several Japanese corporations experimented with Juicer technology, but found it to be too damaging for its users. When Hiroshima and the surrounding cities, "popped" back to Earth and were besieged by monsters, the abandoned technology was pulled out of mothballs to create superhuman soldiers to defend them. However, this was quickly recognized as a tragic mistake and the practice was outlawed. Unfortunately, like Pandora and her box, the chemical monster had been let loose and continues to haunt them. An estimated 6% of the population have undergone illegal Juicer augmentation, the majority of whom are members of the criminal underworld, gang members or ninja clans. Others leave their homeland to embark on a (short) life of adventure as a mercenary or explorer. Some became Juicers for personal glory or the raw excitement — no matter how short lived; many do so for the power; some out of desperation, in hopes of winning a fortune to help their families; others for revenge —**there** are many other reasons, none of them good.

Juicer augmentation can be attained from many body chop-shops and is offered by some criminal organizations at secret locations in the Republic. The law comes down hard on these drug lords, but business is good and has proven to be impossible to stamp out.

Juicer and crazy augmentation are popular because they are "cheap" compared to bionics and other enhancements. A typical Juicer augmentation can cost anywhere from 50,000-80,000 credits and M.O.M./Crazies conversion 250,000 to 450,000 credits. In many instances, an *organization* will offer the enhancements at no monetary cost, provided the character works for them for some mutually agreeable time; typically a minimum of 5 or 6 years. In the case of gangs, ninja clans, and criminal operations, the recipient of the enhancements are likely to swear lifelong allegiance. The **Otomo Shogunate** is an organization that offers Juicer and Crazies augmentation for six years of service in its military and covert operations. **H-Brand** specializes in "juicing" foolish individuals into *Ninja Juicers* and *Ninja Crazies*. They also offer bionics and power armor and create, represent and hire mercenaries of all kinds, but tend to attract the young and foolish and seedy characters looking for power or revenge.

## Genetic Augmentation & Cloning

Limited genetic alteration and cloning are allowed only under strict supervision for medical purposes. Adjusting a person's genetic structure to **remove/prevent/cure** genetic disorders or diseases like **Parkinson's** and **Alzheimer's**, as well as genes that make a person susceptible to particular diseases, are the few legal areas in this field. Genetics and cloning are also used in the creation of replacement limbs, tissue, human organs, and the retro-fitting of cyborgs. However, many people believe the clone is a living individual with human rights and liberties that it and cannot be butchered like cattle. Cloning, even for medical purposes has been under constant fire by numerous political, religious and moral organizations.

Cloning is, in fact, occasionally abused by the wealthy and powerful who have a spare body or three waiting for them in stasis, in case of an emergency, or in some **cases**, to escape old age and prolong life. To avoid controversy, a few privately funded research clinics have moved to secret locations outside of the Republic. Both the **Otomo Shogunate** and **Ichto** are *rumored* to be conducting genetic experiments.

There was a brief period in **Japan's** history where genetic engineering was used to create **superhumans**, but the results were unpredictable, judged inhumane, and often tragic, resulting in deformed, super-powered mutants. Thus, this area of augmentation was outlawed (pre-Rifts research continued in the USA and Canada, ultimately resulting in the Dog Pack).

The expense and high level of skill necessary to perform such experimental augmentation is so prohibitive that there are very few outlets where it can be acquired even illegally. Still, genetic mutants are manufactured from time to time and clones are hidden away for some secret agenda. They are usually either the product of a small fortune and dangerous dreams, or an adventurer given the rare opportunity to become superhuman for agreeing to participate as a test subject in an experiment.

## The Law & Law Enforcement

The laws and social mores are fundamentally the same as 20th or 21st Century Japan. Strict laws and punishments are in place regarding human augmentation and the use of weapons, particularly mega-damage weapons, but otherwise, the basic legal system is unchanged.

Every urban center in the republic has a large police department, complete with a jail, offices and science labs. Weapons, armor, vehicles and equipment are stored in these buildings for the use of police troopers. These men and women are responsible for keeping the peace, making arrests, investigating crimes, **ferreting-out** supernatural predators and inhuman troublemakers, and defending the city against invasion. To this end, the military has a strong presence in the cities and works closely with local police.

Both utilize special investigators, psychics, practitioners of magic, as well as "plain clothes" and "uniformed" officers to patrol the streets. Police and military SAMAS look down from the sky and a variety of power armor help protect the city.

The military and, to a slightly lesser degree, the police, are highly respected and honored in the Republic of Japan. They are seen as heroes, defenders of the weak and champions of justice. Consequently, the average citizen cooperates completely and honestly with the police and military. Likewise, law enforcers show a measure of respect, understanding and compassion toward the needs and fears of the citizens. Corruption is virtually non-existent in the military (less than 2%) and fairly uncommon among the urban police force (about 13% are on the take, accept bribes, or operate fast and loose within the law).

**Weapons Restrictions:** Like most modern cities, it is illegal for the average citizen to carry military issue weapons or **sidearms**. Gun control in the Republic is strict. Less than 2% of the population legally owns a weapon while an estimated 4% illegally own modern weapons; only the police, military and security companies/forces are authorized to carry and use high-tech weaponry.

Adventurers/visitors who enter the Republic are required by law to "check" their weapons at the Immigration and Customs Office. The Republic is a *safe* and law abiding community that does not generally allow its citizens to carry concealed weapons or sidearms. A limited permit *may* be provided under extraordinary circumstances, such as those working with or for the police or government as "freelance" advisors, special envoys, arms dealers, and so on. Those allowed to bring weapons into the country are expected to obey the law or suffer the consequences. Likewise, those with bionic and cybernetic systems and weapons require special authorization, are lectured about the law, and given a brochure about the penalties for the commission of crimes with weapons or bionics.

**Note:** See the *Armatech* description in the *Weapons Section* for details about the weapon restrictions, and the *Cyborg Section* for laws regarding borgs.

## The Military

To a large degree, the military is the primary industry in the Republic of Japan. A great deal of the country's resources and manpower are poured into the armed forces. Numerous companies are devoted to the production of military supplies and others are indirectly involved in supplying or supporting the military. The Republic of Japan tends to operate a bit differently than the other major human powers in the world. First, they concentrate on civil defense and urban combat — if the oni or **D-bee** raiders penetrate a city's defenses, the army is trained to take the fighting to the streets, while minimizing civilian casualties and property damage. While they enjoy a "blitzkrieg" strategy with the use of heavy borgs and power armor, they most often rely upon small, specialized strike and response teams that work in tandem with each other. Rather than have an enormous standing army with low skilled "fodder" troops, like the Coalition States and NGR, they deploy strike teams, anti-terrorists squads, snipers, rescue teams and crack troops. The use of surgical strike teams and highly mobile, man-sized troops augmented by bionics or power armor, gives them the speed, mobility and firepower to get the job done. Of course, it is only their advanced level of technology, the urban combat setting, as well as the terrain of the Japanese islands, with their forests, hills and mountains that make such hit and run, and specialized combat effective. Yet even in a stand-up fight in an open plain, the army of the Republic of Japan should fare well; they are a skilled and precision fighting force armed to the teeth with advanced weapons and robots.

Though smaller in size, these forces are given superior training and more equipment per capita than the armies of the CS or NGR. This high concentration of equipment, weapons and armored vehicles results in two in every five soldiers being issued power armor or assigned to a robot vehicle, and one in four being augmented with bionics. Other supplies, such as ammunition, body armor, weapons, grenades and explosives, are also more readily available to individual soldiers. Resupply for embattled units is always a quick and thorough process.

On an individual basis, the soldiers of the Republic are, better equipped, trained and more experienced than most of their counterparts (average level of experience is 4-7 level). Enlistment in the Armed Forces of Japan is a selective process with high requirements and a focus on high-tech skills, science, computers and leadership. Recruits receive an initial, lengthy and strenuous training program that lasts one year. Typically, 50% wash out and go back into the public sector.

Additional training and upgrades are constant throughout the tenure of enlistment, whether it be for the basic six years or for life. It is anticipated that approximately 65% of the current soldiers will remain in military service for life (40-60 years), particularly the elite of the elite cyborg division, but even the average soldier is anticipated to stay in service for 12 years. "Anticipated" results are given because the current military program is only 14 years old — to date, only 15% have left after a six to 12 year tour of duty. This is, in part, attributed to the incredibly strong sense of duty and patriotism of the people in the entire



nation and the sense of the important role that the military plays in protecting its nation every single day from monsters, aliens and foreign (sometimes dimensional) raiders. Furthermore, this military is regarded as an elite segment of society. Like the samurai of old (and of the New Empire), these men and women are regarded as **selfless** heroes devoted to defending and serving the people of their nation. They truly represent the Republic of Japan's finest and most courageous, and without a doubt, hold the fate of the Republic in their strong and capable hands. The military administration plays upon this idealism and seems to have convinced its current soldiers that those who exhibit great responsibility will be given great power and respect. It is then their duty to never abuse that power and to keep the Republic free and safe for all time.

## Glitter Force

The Glitter Force is an elite corps of soldiers trained in the use of the various types of Glitter Boy power armor deployed by the military. The widespread use of Glitter Boys by the Japanese army far surpasses that of any other organization in the world! They are used primarily to defend the perimeters of the cities and the borders of the nation, but can also be deployed in urban settings and are dispatched in force on military campaigns against encroaching oni. They are often used in conjunction with the SAMAS and/or support bots and lead the charge into battle, followed by bionic soldiers, other power armor and ground troops.

## The Navy

Since the city of Hiroshima reappeared 15 years ago, its people have spent much of their time exploring the immediate environment on the islands of Japan, rebuilding the Japanese nation, and establishing defenses against the horrors of this dangerous new world. Consequently, they have not invested much energy in creating a formal navy. Instead, the Republic (and **Ichto**) uses its power armor, robots and aircraft to survey the seas and to defend their shores.

Of course, a variety of basic pleasure craft, motorboats, hydrofoils, and sailboats, are reasonably available. However, the once friendly waters around the islands are unpredictable and infested with monsters. Storms often erupt in the middle of a sunny day, hurricanes are more violent than ever, and tidal waves and ley line storms can appear without warning. Furthermore, elemental forces, creatures, entities and monsters of all kinds lurk beneath and above the waves. There are also pirates and raiders from Korea, China, the Philippines and beyond. Consequently, most average people avoid traveling the seas.

**Note:** See *Rifts Underseas* for a wide selection of sailing ships, military boats, submarines and other sea vessels.

## D-Bees of the Republic of Japan

Less than half a million residents in the Republic of Japan are non-human dimensional beings (**D-bees**). This is largely because of the nation's unique appearance on the island 15 years ago and the fact that there are not a great number of D-bees on the Japanese islands compared to humans and oni.

All intelligent life forms, meaning **humanoid** D-bees, qualify for citizenship in the Republic, as guaranteed by their constitution. Sentient life forms willing to live under the laws of the nation and respect human life, are granted the same basic rights as their human counterparts and are subject to the same laws. Once they have completed the necessary steps, D-bees are allowed to become full citizens! In this respect, the Republic of Japan is enlightened when compared to the other major human governments in the world.

## Earth For Humanity

Ever since the first monster invasion 15 years ago, a growing minority of the human population have become **militantly** opposed to the presence of non-humans in Japan. These individuals are human supremacists with strong feelings of hatred for all D-bees. Over the last

decade, they have become more organized and have been building in numbers. Several organizations of human-supremacists have developed, although most are nothing more than political groups lobbying for the expulsion of all non-humans.

One dangerous group advocating violence against D-bees has been growing in support. This group is known as **Earth for Humanity**.

Many of its members are hostile and bitter survivors of monster attacks or have lost loved ones to them. More than a lobbying group, Earth for Humanity has become the battle cry of human supremacists bent on the genocide of all alien life forms. These men and women believe that all non-humans, worldwide, should be destroyed. Wearing black military style coveralls, these fanatics engage in violent marches and protests as well as wanton acts of murder, torture and vandalism. Under the cover of darkness, they prowl D-bee neighborhoods, beating, murdering and terrorizing the residents. More often, D-bee visitors are targeted, and the group frequently organizes expeditions to regions beyond the Republic to slaughter D-bees there, without fear of legal reprisal. Needless to say, these miscreants would make **KarlProsek** proud.

Fortunately, *all* the human-supremacists combined represent less than 1% of the overall population in the Republic of Japan. However, Earth for Humanity has affiliate groups in the Otomo Shogunate and Ichto where human supremacist sentiments are shared by 46% and 31% of the people respectively.

## Foreign Relations

There has been little time or opportunity to explore much of what lies beyond the islands of Japan, or to make contact with other *human* civilizations. In fact, not all of Japan has been explored by the Republic of Japan. The fledgling nation has been in survival mode, building and securing its position in an uncertain world against unimaginable odds. The isolation of the community has kept it hidden from the world and given it time to establish itself and to build a reasonably solid foundation.

Only now is the Republic of Japan beginning to expand its view of the world and make contact with those beyond its own borders. The Republic focuses much of its attention on the Japanese islands and the many cultures and kingdoms that now inhabit them. It has established communications with such notables as **Ichto**, **Otomo/H-Brand**, **Takamatsu**, and the New Empire, among others. It has also had increasing contact with sailors, including **Horune** pirates, and the occasional **pneuma-biform**.

**China:** A handful of outposts have been established on the coasts of China, Korea and Taiwan, but these are little more than staging areas from which to launch raids or exploratory expeditions into the mainland. China and Korea are regarded as lands of monsters and barbarism, dominated by monsters. The Republic doesn't yet have a good understanding of the extent of inhuman dominance over these vast lands, but fears the worst and intends to investigate with great caution.

**The New Empire of Japan:** The anti-technology proponents of the New Empire have dedicated their lives to making the Republic see the folly of their life-style and give up technology. Likewise, many technocrats believe that the **anti-techies** will change their minds and adopt technology when they see that it can be beneficial to life. This has led to some philosophical differences, protests and even some violent clashes. However, generally speaking, these two nations are extremely tolerant of each other, and tend to regard each other highly. At worse, they have a friendly adversarial relationship (not unlike Japan and the USA of the 20th Century). If one fell under siege by hostile forces, especially non-human or foreign, the other is likely to rush to their aid.

Many traditionalists and **Shintoists** believe that it was the influence of the 340,000 **kami**, "spirits," of all the people who perished in the atomic fury that destroyed Hiroshima in the 20th Century, who saved Hiroshima from a second apocalypse. Furthermore, in a bizarre way, the people of the Republic of Japan are the "ancestors" of those who live in the New Empire. It is, in part, in deference and respect to their ancestors

that many anti-techies have vowed to save the people of the Republic from themselves, and vice versa.

**Ichto Province:** This relationship is becoming increasingly strained as the political powers in Ichto defiantly flex their muscles and do as they please without regard to the Republic of Japan, the New Empire or other inhabitants of the Japanese islands. Their militant attitude toward the traditionalists of the New Empire, compared to the "soft," tolerant attitude of the Republic, and a history of rivalry with **Armatech**, only adds to the turmoil between these two super-powers.

**Takamatsu:** The strongest of allies with the Republic of Japan.

**Otomo Shogunate & H-Brand:** The Republic regards these two united powers as self-serving opportunists of a belligerent and destructive nature. Neither kingdom likes the other, but direct confrontations have not yet occurred, except in neutral territories like The Zone, China, at sea, and other "free" territories. Instead, Otomo and H-Brand get a sadistic pleasure from *supplying* the criminal underworld, bandits, meres and other potential enemies of the Republic with the weapons and technology to make the fledgling nation's life miserable. Forces at Otomo and H-Brand also encourage the spread of rumors and lies to the peasants and wilderness folk that the people of the Republic are not human.

**The Zone — Demon Hordes:** This is a hostile territory for any human, because it is the domain of the oni — Japanese "demons" who capture, molest, beat, enslave and murder humans and human-like D-bees. The Republic of Japan was attacked by forces from the Zone only hours after returning to Earth and have become mortal enemies.

The Republic has dispatched numerous expeditionary forces and rescue teams (to free slaves) into The Zone with varying levels of success. Regardless of the humans' view of success, each foray into the domain of demons provokes the horrid creatures and creates lasting hatred. The oni clan leaders in The Zone regard the Republic of Japan (and to a lesser degree, Ichto and the New Empire) as their number one rival and the major obstacle in their conquest of all of Japan!

**The Freelands:** The rugged wilderness of northern Honshu and Little Honshu are unclaimed lands where adventurers, mercenaries, oni, D-bees, eta and other *undesirables* scratch out their existence. Most of these tough wilderness folk regard the people from all of the other kingdoms as weaklings or heartless technocrats.

**Coalition States/The Americas:** No knowledge or contact, as is true of most of the world.

**Triax and the NGR:** None. The New German Republic has heard a few dozen stories about a Japanese Empire, but the details are conflicting and incongruous. For example, some stories suggest the islands are mostly a barren wilderness populated by a kingdom of demon and supernatural beings who ravage the islands and enslave the tiny human population. Other stories tell of a kingdom of mystic warriors, priests, sorcerers and ancient gods. More recently, tales of a fabulous high-tech empire with wonders the equal of Triax, have begun to surface. The NGR and Triax dismiss these conflicting tales as myths and legends of seafaring people and pirates, and that the truth is probably bits and pieces from all three types of stories. They don't realize the stories really talk about the great powers of Japan located at The Zone, The New Empire and the Republic of Japan.

The Republic of Japan has intercepted a couple of radio communications from Triax submarines and have heard the occasional story from pirates and adventurers about the great kingdom of Europe known as the NGR and Triax, but they have never made contact with people from that nation. However, such a meeting is inevitable and could make for an impressive alliance. See *Rifts Underseas* for details about the NGR's secret navy.

**Splugorth of Atlantis:** The powers at Atlantis and the **Splugorth** in general, have little influence or in-depth knowledge regarding this demon infested part of the world. They acknowledge the dominance of other powers in China, Japan and Asia and, at least for the moment, have turned their attentions to other matters in Atlantis, Europe, Africa,

and the Americas. However, Lord Splynncryth has recently learned from the Horune that a new technological super-power has appeared in southern Japan. This has piqued **Splynncryth's** curiosity and he plans to send a friendly envoy of minions to make contact and investigate. However, time is a strange and fleeting thing to the Splugorth, so such an expedition is likely to be years from now (1D6 years, perhaps longer depending on **what's** going on in other parts of the Megaverse).

If the Splugorth should ever make peaceful contact with the Republic of Japan, they could probably trick the authorities into believing that they are a peaceful nation looking to exchange ideas and trade. The Splugorth may see the Republic as a valuable pawn in getting a foothold in that part of the world and would also like to get their paws on Armatech weapons and technology. The Splugorth are likely to view the oni and Japanese gods as rival powers and avoid relations with them.

On the other hand, if the Republic of Japan refused the **Splugorth's** hospitality or had already been turned against them by the New Navy, Tritonia, Lemuria or the NGR, then the Splugorth may try to manipulate the oni and other enemies of the nation. This could lead to alliances with Otomo and H-Brand, and/or other shogunates, mercenary bands, the Horune and who knows who. Only time will tell.

**Tritonia:** The Republic has heard about this distant sea nation of mutants and humans, but has had no direct contact with them. Only a tiny handful of adventurers and pirates have ever been to Tritonia.

Tritonia has only heard stories from adventurers, pirates and freebooters. Like the NGR, they don't know which stories to believe and tend not to worry about Japan. See *Rifts Underseas* for details.

**Nemo-2 & the New Navy:** Nemo and his forces have heard stories and have caught a few glimpses of the great cities and machines of the Republic, but have avoided contact. Until they know more about these people, Nemo believes it best to remain hidden beneath the waves. See *Rifts Underseas* for details about the New Navy.

**Naut'Yll:** The rare, raiding party from the Naut'Yll empire has attacked Japanese ships and occasionally raided the Indonesian islands. The aquatic warriors don't even know the Republic of Japan exists. See *Rifts Underseas* for details about the Naut'Yll.

**Horune Pirates:** The monstrous dimensional raiders have plundered the island of Japan, Indonesia, Polynesia, and surrounding seas, oceans and coastlines for decades. Clever in their own way, the Horune have recognized the strength of the Republic of Japan and have steered clear of trouble with them — at least around the islands of Japan. Encounters out at sea may be another story entirely, but the Republic currently avoids sea travel and thus, provides the Horune with little opportunity to test their mettle in combat.

The pirates have tried to be sly and establish trade relations with the Republic, but the authorities had heard all about the malevolent pirates from their allies at Takamatsu and the New Empire, and have rebuffed all offers. The Republic's military has had only a few minor skirmishes with the Horune on the few occasions when Japanese troops boarded the pirate ships to free human slaves. While this has angered the Horune, the pirates backed down to superior forces, but wait for the day to extract their revenge. For the moment, the Horune plunder weaker victims around the island and trade with the eta and oni. **Note:** One Horune pirate clan has a secret base located on an island off the northeastern tip of Honshu. Another larger and more powerful clan occupies the island of Okinawa. See *Rifts Underseas* for details about the Horune.

**Other people and places:** The Republic of Japan knows very little about the other people, gods and beings that inhabit their island or the rest of Japan, particularly those north of Otomo.

# Character Classes

## New Empire: People & Adventurer O.C.C.s

Demon Queller O.C.C.  
Monk: Bishamon O.C.C.  
Monk: Sohei O.C.C.  
Mystic Ninja O.C.C.  
Priest: Yamabushi O.C.C.  
Ronin O.C.C.  
Tengu R.C.C.  
True Samurai O.C.C.

## Republic of Japan

### & Mercenaries, and High-Tech O.C.C.s

Cyberoid/Japanese City Rat O.C.C.  
Cyber-Samurai O.C.C.  
Cyborg: Soldier O.C.C. (police & military)  
Cyborg: Dragon 'Borg O.C.C.  
Glitter Force Trooper O.C.C.  
Military: Infantryman O.C.C.  
Military: Police Officer O.C.C.  
Military: Robot Pilot O.C.C.  
Military: SAMAS Samurai Pilot O.C.C.  
Ninja 'Borg O.C.C.  
Ninja Crazy O.C.C.  
Ninja Juicer O.C.C.  
Ninja Techno-Wizard O.C.C.  
Tech-Ninja (modern ninja) O.C.C.

## Cyberoid O.C.C.

The average citizen of the Republic of Japan is augmented by cybernetics and is an expert in the use of computers. A full 45% of the population call themselves *Cyberoids*—citizens the Coalition States might characterize as *city rats*. These characters understand computers and electronics as good as most North American operators and scholars. They know computers inside and out, can hack into computers, computer networks, communication systems, and love video and virtual reality games. Cyberoids are connected to **cyberspace** via a multitude of cybernetic enhancements.

The most extreme (about 20%) spend 8 to 12 hours a day "on-line" with other Cyberoids. These extremists also tend to congregate in small elite groups (at least they consider themselves "elite") and some have even organized clubs and gangs. **Cyber-gang** members are frequently anti-social elitists who are cool and aloof toward anybody not in their gang, even other Cyberoids. As members of a "gang," they wear similar clothing, and share the current craze of painting or tattooing their faces. These characters tend to be the most intense and skirt the edge of the law, often slipping over the edge into the criminal cesspool of the dark side of city life. These are the fringe people who roam the back alleys and visit body chop-shops to get "**jacked-up**"—acquire cybernetic implants as a means of augmentation. To this end, they often acquire illegal or experimental systems; sometimes fun, often times dangerous.

As savvy as these characters are in some areas, they often find themselves sucked into the criminal underworld. A common ploy used by the **Yakuza**, the black market, local gangs and other criminal organizations, is to goad a Cyberoid into getting cybernetics he or she can't afford and then convince, threaten or blackmail him into doing something illegal to pay for the item. Another ploy is to blackmail the character by threatening to anonymously tip off the police that he's hardwired to illegal **cyberware**. Yet another is to play on the character's anti-social ten-

dencies and feed his ego or sense of what's fair and what's not, and help him do what "he wants," or to get even. The old stand-bys of sex, drugs, bribes and extortion are also part of this sad scenario.

Illegal activities involving Cyberoids may utilize the character's computer skills to hack into computers to gather (damaging) information, to delete or alter files, spy on people or businesses, transmit coded files, or destroy data files. Without realizing it, the character may find himself involved in evidence tampering, industrial espionage, extortion, numbers running, money laundering, and a host of other crimes. Other activities may involve being a "street soldier," in which the character physically handles illegal data or contraband. This can include "holding" (keeping safe and away from the police) or "running" (delivering) data, money, drugs, electronics, weapons, cybernetics, magic, stolen goods, murder weapons, and other illegal items or data. They can also function as look-outs, drivers, **shill/distractions**, thieves, con men, or thugs.

Some (6%) like being "on the edge," and welcome a life in the criminal underworld. On the streets, these Cyberoids turned professional criminals are called "Cyberoid Punks" or "**Cy-Wees**," short for "Cyberoid Weasels."

The Cyberoid character is streetwise, savvy and extremely capable in a high-tech environment and is masterful with computers. Many have inquisitive minds and high **I.Q.s**, while others just crave adventure. Consequently, they may join a group of **adventurers** or mercenaries to explore the wilderness, see new things, and even to right injustice or fight demons. Their intentions may be good, but all too often they are like fish out of water when not in a high-tech city environment. Most, especially young characters, also tend to be overconfident and ill prepared for the harsh world of magic and war beyond the safe border of the Republic.

**Attribute Requirements:** None, however, characters with an **I.Q.** under 12 reduce their O.C.C. skill bonuses by half. A high M.E. can't hurt either.

### O.C.C. Skills:

Basic Electronics (+10%)  
Basic Mathematics (+20%)  
Language: Japanese & American (+20%)  
Literacy: Japanese & American (+20%)  
Radio: Basic (+20%)  
Computer Hacking (+20%)  
Computer Operation (+20%)  
Computer Repair (+10%)  
Find Contraband, Weapons & Cybernetics (+12%)  
Streetwise (+12%)  
Pilot Motorcycle (+10%)  
Hand to Hand: Basic Martial Arts/Judo  
Hand to hand: basic martial arts/judo can be changed to aikido for the cost of two other O.C.C. skills, or to kendo or karate for the cost of three other skills.

**O.C.C. Related Skills:** Select five other skills at level one, plus select one additional skill at levels three, six, nine and twelve. All new skills start at level one proficiency.

Communications: Any (+10%)  
Domestic: Any  
Electrical: Any (+5%)  
Espionage: Any  
Mechanical: Any  
Medical: First Aid only



K. SIEMBIEDA - 1995

Military: None  
 Physical: Any, except acrobatics and boxing.  
 Pilot: Any  
 Pilot Related: Any (+5%)  
 Rogue: Any (+8%)  
 Science: Mathematics and chemistry only (+10%)  
 Technical: Any (+5%)  
 Weapon Proficiencies: Any; lean toward modern weapons.  
 Wilderness: Any

**Secondary Skills:** The character also gets to select two secondary skills from the previous list at levels one, four and ten. These are additional areas of knowledge that do not get the advantage of the bonus listed in the parentheses. All secondary skills start at the base skill level. Also, skills are limited (any, only, none) as previously indicated in the list.

**Standard Equipment:** Those involved in crime or adventuring will have managed to lay their hands on a suit of light M.D.C. body armor and an energy weapon. They have a set or two of clothing, and basic equipment, including gas mask or air filter, sunglasses, two hand-held computers, several dozen 4.2 meg disks, language transla-

tor, utility belt, backpack, sleeping pack, canteen, flashlight, cigarette lighter and a motorcycle.

**Money:** The character typically has a full-or part-time job that should provide a monthly salary of 2500 credits. The savings of a first level character is  $2D4 \times 1000$  credits; they tend to spend their money quickly on cyberware, computer equipment, software, electronics and simple luxuries. That usually means having  $1D6 \times 1000 + 10,000$  dollars' worth of computer gear. Successful, but low level, professional criminals will get  $1D4 \times 1000$  more a month and also get special bonuses or equipment for a job well done. The character will also have an inexpensive apartment with two bedrooms (one is a computer workshop), a private bathroom, kitchen (with refrigerator and microwave oven), and living room.

**Cybernetics:** Starts with a gyro-clock/compass and universal headjack and ear implant, plus five of choice (legal or illegal). Additional cybernetic implants will usually be purchased or acquired throughout the character's lifetime. Note that the Cyberoid use cybernetic systems not military bionics. However, the character may consider getting one bionic limb (with as many as three bionic weapons in it), and will not hesitate at getting cybernetic or bio-system prosthetics, eyes or organs to replace any that are lost in combat.

---

# Cyber-Samurai O.C.C.

## a.k.a. The "False" Samurai

---

The samurai is a heroic figure in Japanese history, surrounded by myth and legend. In the feudal ages, samurai were brutally efficient warriors with incredible battle prowess. Their abilities included horsemanship, archery and swordsmanship without equal. During the thousand years that the samurai reigned, they were more than mere soldiers. The samurai represented an elite caste of nobility that rose from a powerful military ruling class. Even after the age of the samurai had come to an end in the 19th Century, those of samurai lineage were considered special; many Japanese can proudly trace their samurai lineage for hundreds of years.

The *cyber-samurai*, sometimes called the **techno-samurai** or **tech-samurai**, of Rifts Japan is a modern warrior who emulates, in part, the ways of the old samurai. They may know martial arts, handle a sword, carry themselves with a swagger or air of nobility, and usually dress the part, right down to vibro-daisho and samurai armor. Some even try to live by the samurai code of ethics, *Bushido*, but they are not traditional or "True" samurai. Despite any legitimate claim to samurai ancestry, some are little more than the Headhunters of North America or any high-tech mercenary.

The cyber-samurai, seeking a way to "equalize" the advantages of high-tech weaponry, usually become partial conversion 'borgs, sacrificing part of their humanity to become powerful warriors. They still follow the "Way of the Sword and the Bow," but the sword is often a **vibro-blade**, and their bows fire arrows with explosive warheads. Instead of the horses of old, many of these "new" Samurai ride motorcycles, hover vehicles or use power armor.

The most noble and/or dedicated warriors will *act* the part of the samurai, and some may actually be modern-day equivalents to their traditional cousins. These are men and women of honor and ethics, who "live to serve" their family clan, **nation/kingdom**, military, or corporate masters — such as **Ichto**, the Otomo **Shogunate/H-Brand**, or other corporations or small kingdoms. A few corporations in the New Republic and Ichto value these cyber-samurai as loyal bodyguards, agents and soldiers. Some cyber-samurai **will** pledge their loyalty to that corporation and treat it as he would a shogun or **daimyo** (feudal lord). The New Republic's Army has a few elite units that use these modern samurai, but for the most part, prefers to rely on less traditional soldiers and officers.

A few of these warriors wander the land, serving no one. These are the **Cyber-Ronin**, masterless warriors who often work as mercenaries, bounty hunters, adventurers, bandits, or champions of the helpless, depending on their orientation and alignment. Unlike "true" ronin who often are filled with remorse and anguish for their loss of a master, cyber-ronin see themselves as romantic figures, and will often turn down offers of employment, cherishing their independence. Most of these independents are 21st Century Japanese who have lost much of the traditional behavior that was reborn during the 300 years since the Great Cataclysm. They are often irreverent of the traditional samurai, and do things their way. Despite their lack of respect, many of these "modern ronin" are as true to the ideals of the samurai as the most dedicated "true" warrior.

Note: Approximately 10% of these pseudo-samurai have "true," *ancient* samurai swords from **pre-Rifts** Earth; the most powerful of these ancient rune weapons. 15% have "true" **samurai swords** of more recent creation and of lesser power (see the *True or Traditional Samurai O.C.C.* for full details about these weapons). The rest rely entirely on **vibro-blades**, energy weapons and modern equipment.

The **traditional samurai** regards these "machine warriors" as "false samurai." Pathetic mimics of the followers of *Bushido* — "the Way of

the Warrior." Most "True" Samurai feel little but contempt for cyber-samurai and cyber-ronin, and often criticize, insult and degrade them. Many refuse to work with, or even talk to, them. Some nasty duels between "false samurai" and "true samurai" have arisen from this elitism. Some "true" samurai even make a point of challenging these modern warriors with the deliberate intent of belittling them in combat. Traditional ronin tend to be more accepting and patient with cyber-samurai, although they too may regard them as "false" samurai and as lowly as they. However, even the most ardent traditionalist have come to respect and acknowledge some of the heroic cyber-samurai who have proven themselves to be dedicated champions with enough courage and determination to truly call themselves "samurai."

## Cybernetic and Bionic Enhancements of the Cyber-Samurai

**1. Partial Bionic Reconstruction:** The legs and arms have been replaced with mechanical limbs; the **pelvis/hip** area, shoulders, collarbone and spine are reinforced with metal rods, exoskeleton and cybernetic implants to support the new bionic additions. Some internal organs are replaced with cybernetic ones. The character becomes an M.D.C. cyber-gorg with 180 M.D.C. for the main body. The character's attributes are also changed as follows: P.S. 22, P.P. 18, Speed 50 (35 mph/56 kph).

**2. Additional Bionic Features:** The character gets an additional four bionic features and accessories from Rifts, pp. 239-243, and/or those listed in this book. Other accessories can be purchased at a later day, at the character's expense (or his **employer/liege** may provide them after the character proves himself).

**3. Cybernetic Implants:** In addition to the partial bionics, the character can start out with up to five cybernetic enhancements, with the exception of **cyber-armor**. Other accessories can be purchased at a later day at the character's expense (or his **employer/liege** may provide them after the character proves himself).

**Note:** The cyber-samurai does not have the mystical training and insights of the "true" samurai. Therefore, he does not get any of the special powers and skills of that O.C.C.

## The "False" Cyber or Tech-Samurai O.C.C.

**Alignments:** Any alignment, but 12% are principled, 12% aberrant, 20% scrupulous, 10% unprincipled, 20% anarchist and 26% other.

**Attribute Requirements:** M.E. and M.A. 10 or higher; physical attributes are augmented by the partial bionic reconstruction.

### O.C.C. Skills:

- Basic Radio (+10%)
- Basic Math (+10%)
- Language and Literacy: Japanese (98%)
- Language: American (+10%)
- Computer Programming (+10%)
- Horsemanship (+20%)
- Wilderness Survival (+5%)
- Piloting: Two of choice (+10%)
- W.P. Sword
- W.P. Archery and Targeting.
- Hand to Hand: Karate or Jujitsu

Note: The cyber-samurai may learn **Zanji Shinjinken-Ryo** (described in the True Samurai O.C.C.) at the cost of two "other" skills. Archery and Targeting can be changed to Samurai Archery at the cost of two "other" skills.

**O.C.C. Related Skills:** Select six other skills. Plus select an additional skill at level three, one at level six, one at level nine and one at level twelve. All new skills start at level one proficiency.

Communications: Any (+5%)

Domestic: Any (+5%)

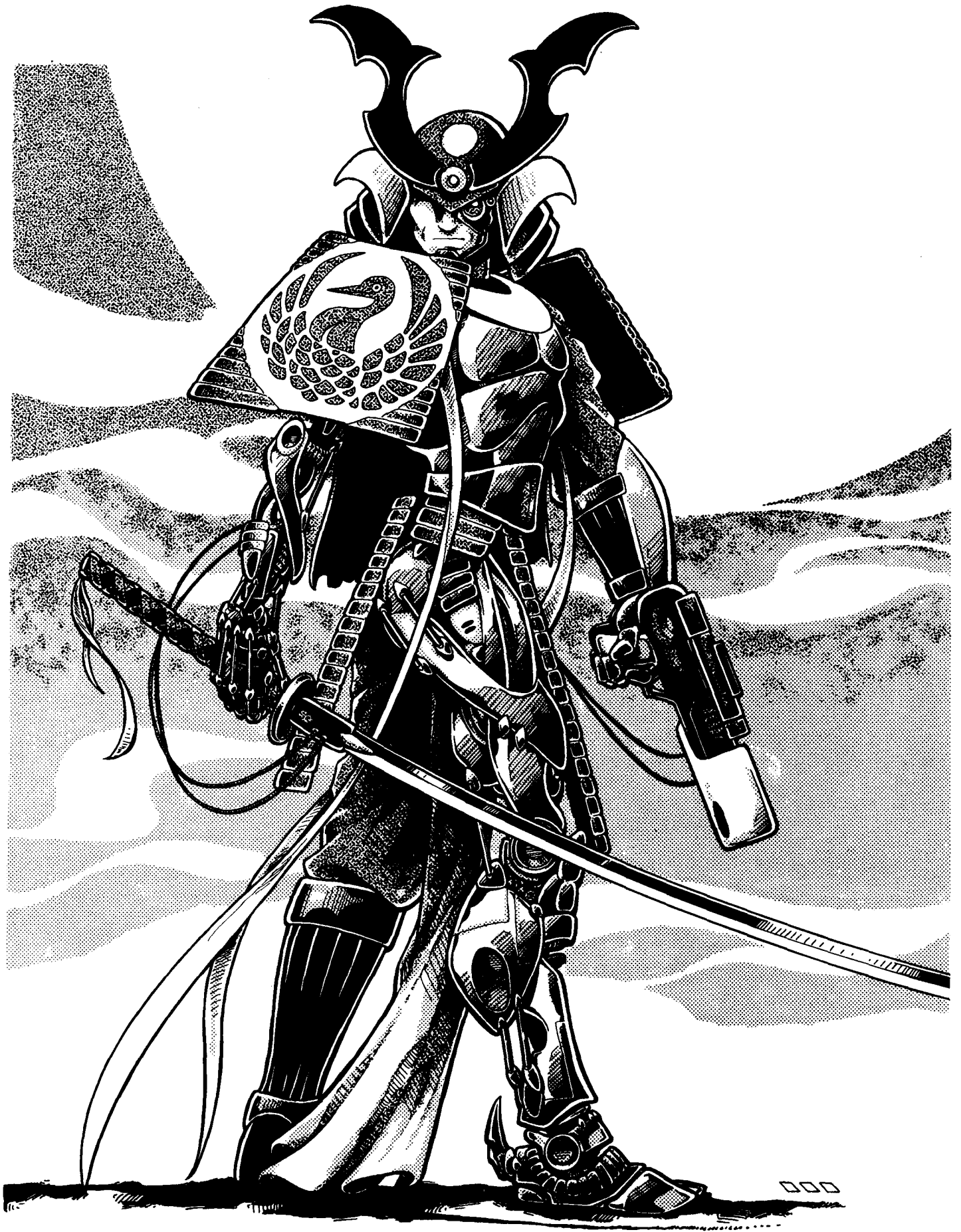

Electrical: Any  
 Espionage: Any (+5%)  
 Mechanical: Any  
 Medical: First Aid and Paramedic only.  
 Military: Any  
 Physical: Any (except Acrobatics)  
 Pilot: Any (+5%)  
 Pilot Related: Any (+10%)  
 Rogue: Any  
 Science: Astronomy and Mathematics only  
 Technical: Any (+10%)  
 Weapon Proficiencies: Any  
 Wilderness: Any

**Secondary Skills:** The character also gets to select three secondary skills from the previous list at levels 1, 4, 8, and 12. These are additional areas of knowledge that do not get the advantage of the bonus listed in the parentheses. All secondary skills start at the base skill level. Also, skills are limited (any, only, none) as previously indicated in the list.

**Standard Equipment:** A suit of "Samurai" mega-damage body armor (high-tech version with 1D6x10+60 M.D.C.) or one of the other types of armor available in Japan (see the weapons and armor section), however, most work very hard at looking the part of a samurai. Gear is minimal, several changes of clothes (kimonos), a utility belt, ammo pouches, backpack, knapsack, 2 canteens and 2D4 days of rations.

Armament typically consists of a samurai longbow with 20 regular arrows and 10 high-tech arrows of choice, an energy weapon of choice and 1D4 extra E-clips, two vibro-blades or ancient weapons of choice, and an S.D.C. Daisho.

For transportation, the samurai can have a normal horse, a robot version of a horse, or a motorcycle, hover-cycle, jet pack, or similar open vehicle.

**Money:** The character starts with 2D6x1000 in credits and 2D4x1000 in salable Black Market items. Employed samurai may have a stipend or salary of 1D4x1000 credits a month, which may be raised if he gains favor with his master, be it a daimyo, corporation or government.

**Cybernetics:** See above.

---

## Tech-Ninja O.C.C.

---

The influence of the ninja is not something lost to the past, rather it continues into the time of Rifts Earth. Contrary to popular belief the ninja clans of old have survived through the centuries. Although they have become more and more secretive, the clan masters have continued instruction in the art of **Ninjitsu**, thereby preserving the clans. Even the brutal times after the coming of the Rifts could not exterminate the ninja clans.

The post-apocalyptic years have produced two types of ninja. The first one is the traditional shadow warrior of old, a mystic master with great powers of stealth and destruction (see the *Mystic Ninja O.C.C.* for more information). The other, a modern counterpart.

The new breed of tech-ninja (also known as **cyber-ninja** or **ninja-techie**) serve the many corporations of Japan. In a time when corporations, can be brutal and even deadly, these shadow assassins are an ideal way to conduct covert operations against one's business rivals. Espionage, sabotage and the occasional assassination or kidnapping mission are performed by these hidden clans. Each major corporation, including **Ichto** and **H-Brand**, has a "stable" or clan of tech-ninja at their disposal.

**H-Brand** actually hires out its ninja clan to other nations and kingdoms; this allows the corporation to have a much larger force of ninjas at their disposal and pick up some valuable secrets along the way. The ruthless corporation has gone even further, enhancing one-third of its tech-ninjas with full bionic conversions and juicer and crazy augmentation (see the *Ninja Juicer*, *Ninja Crazy* and *Ninja 'Borg O.C.C.s*, below)!

Unlike the traditional ninja, who have family clans that can trace their ancestry through the centuries, tech-ninja are recruited and brought into the fold from a number of sources. Most of these warriors are orphans or unwanted children, adopted or kidnapped at a very early age. These children are indoctrinated in the importance of loyalty to the clan, and taught never to trust the outside world. Games of deceit and trickery are encouraged; outsiders are called "fools good only to be used, then discarded." Lying becomes a way of life for the young assassin, for they must keep their secret at all costs.

Like the traditional ninja, tech-ninja specialize in espionage, silent and covert operations, and other illicit tasks. Many tech-ninja rarely wear their black costumes except when undertaking commando missions of assassination or surprise attacks. In fact, most of these assassins live out most of their lives in an seemingly "normal" fashion. These infiltrators often masquerade as businessmen, policemen (some are actually police officers who have been working for the ninja clans before they even entered the **Police Academy!**), and soldiers. Others join groups of mercenaries and adventurers. Most of them never forget that they are ninja and that their ultimate loyalties are to their clan.

Tech-ninja are trained in the traditional skills of stealth, hand to hand combat, and evasion. Most of them are trained to survive in cities, and have little in the way of woodcraft skills. Emphasis is placed on the evasion of security systems and computer hacking, as well as the art of hand to hand combat. Most of the "wet work" (an ancient expression for murder) is left to "specialists" like the 'borg, juicer and crazy. The typical tech-ninja is expected to pass himself (or herself) off as a corporate executive, break into the office of a corporation president, hack into his personal computer and then climb out the top floor of a skyscraper!

The *traditional ninja clans* have nothing but contempt and hatred for the tech-ninja. These high-tech assassins are considered to be paltry imitators who sully the ninja name by using it. Tech-ninja in turn, think the traditionalists are dinosaurs living in a dead past. They claim that their cybernetics are fully the match of any mystical power, that their ninja juicers can move faster than any second-rate martial artists, and that their 'borgs can crush the toughest skin-hardening adept!

Some corporations, especially in the New Republic, have small teams of tech-ninja under their employment, but they keep their activities at a minimum. A few of the more benevolent corporations have actually "loaned" their ninja teams to the government to conduct covert operations! **Tech-ninja-led** operations have successfully acquired information from H-Brand (after having to sidestep **H-Brand's** own ninja), and have struck at the oni regions. In return for this cooperation, the government has turned a blind eye to occasional industrial espionage operations, as long as no innocents are harmed.

**Note:** If a player character tech-ninja is working among non-ninja, he should typically try to pass himself off as a high-tech thief/city rat, a spy, or a warrior/adventurer. If the other characters are working for or serving the same corporation the ninja clan serves, the character might choose to reveal his true profession, but only if he is convinced he can trust the other characters.

### Tech-Ninja

**Attribute Requirements:** P.P. 10. M.A. 12. High physical attributes are desirable but not necessary.

#### O.C.C. Skills:

Mathematics: Basic (+10%)  
 Language: Japanese (+20%)  
 Literacy: Japanese (+15%)  
 Computer Operation (+5%)



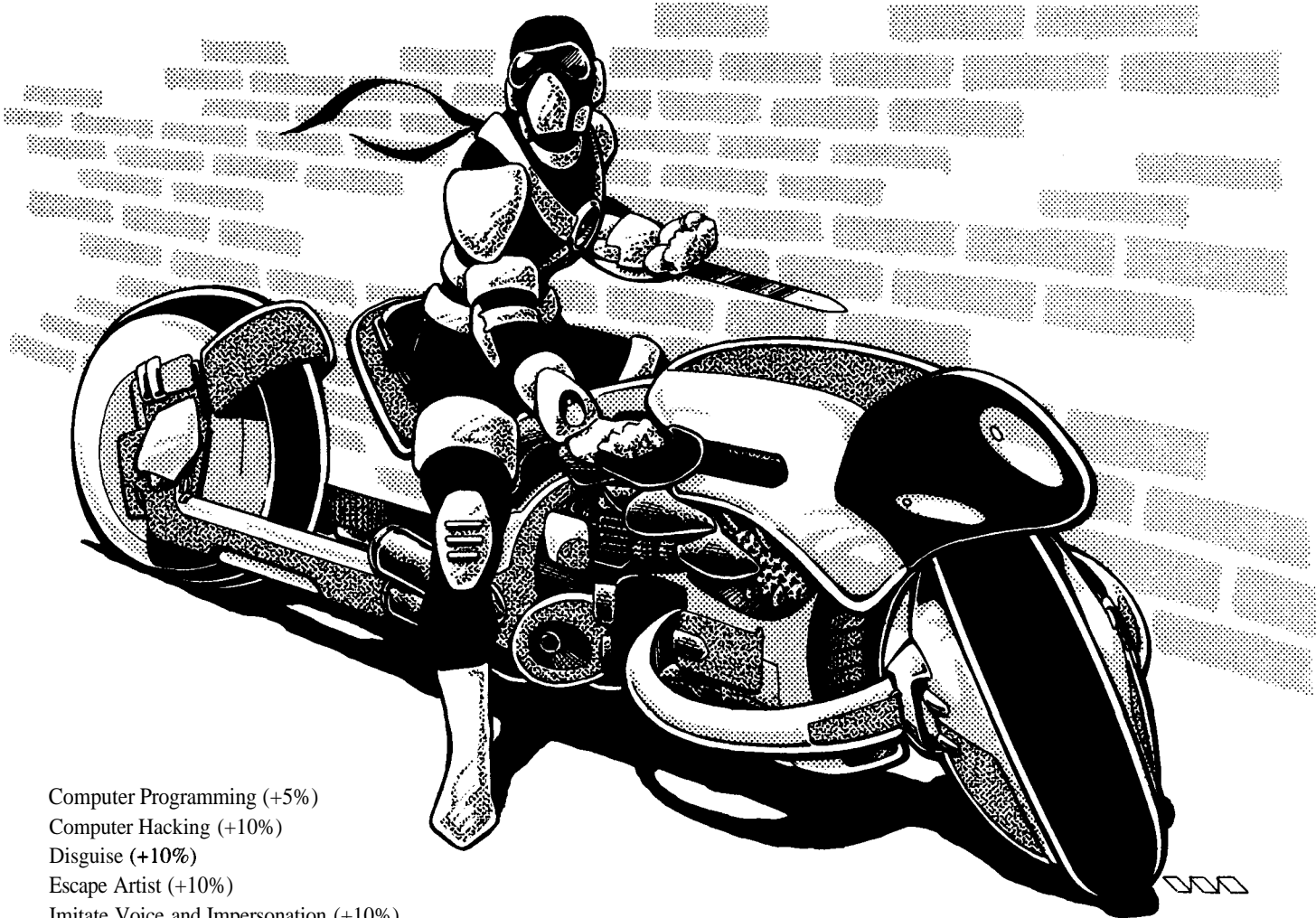

Computer Programming (+5%)  
 Computer Hacking (+10%)  
 Disguise (+10%)  
 Escape Artist (+10%)  
 Imitate Voice and Impersonation (+10%)  
 Climbing (+8%)  
 Prowl (+10%)  
 Disguise (+10%)  
 W.P. Three of choice  
 Hand to Hand: Assassin (see *Rifts RPG*)

**Note:** Most tech-ninja do NOT know the ancient combat styles of the true ninja. However, a tiny handful have managed to learn this secret art, and can change hand to hand: assassin to hand to hand: ninjitsu at the cost of three "other" skills. In the alternative, hand to hand: assassin can also be replaced with aikido, jujitsu or karate at the cost of one "other" skill.

**O.C.C. Related Skills:** Select eight other skills, but at least two of these skills must be from the rogue category. Plus select an additional skill at levels three, seven, ten and twelve. All new skills start at level one proficiency.

Communications: Any (+5%)  
 Domestic: Any  
 Electrical: Basic Electronics only  
 Espionage: Any (+10%)  
 Mechanical: Basic and automotive mechanics only  
 Medical: First aid and criminal sciences and forensics only (need prerequisites under science).  
 Military: Any(+10%)  
 Physical: Any  
 Pilot: Any  
 Pilot Related: Any (+5%)  
 Rogue: Any (+10%)  
 Science: Any

Technical: Any  
 Weapon Proficiencies: Any  
 Wilderness: Any (+5%)

**Secondary Skills:** The character also gets to select five secondary skills from the previous list. These are additional areas of knowledge that do not get the advantage of the bonus listed in the parentheses. All secondary skills start at the base skill level. Also, skills are limited (any, only, none) as previously indicated in the list.

**Standard Equipment:** A suit of personalized, mega-damage body armor, most will use IA-100 Infiltrator Armor (60 M.D.C., concealed **vibro-blades** inflict 2D4 M.D.). Several nondescript sets of clothing and disguises, rubber-soled tabi boots, and a black or camouflage ninja suit. Also a hand-held computer, portable compact disc recorder/player and headphones, video disc player, micro-film camera (fits in the palm of the hand), pen flashlight, large flashlight, laser scalpel, lock-picking tools, small crowbar, basic tool kit, utility belt, backpack, air filter and gas mask, tinted goggles, canteen, 50 feet (15.2 m) of knotted rope, grappling hook and one Ninja Emergency Kit.

**Note:** The equipment section has descriptions of other specialized ninja equipment. It is up to the game master to determine whether or not a ninja character should start with any additional special equipment.

The modern ninja places an emphasis on the use of technology, especially in the areas of equipment and weapons. The character starts with one energy weapon of choice (typically a small pistol or small concealed **weapon**), 4 extra **E-clips**, two smoke or riot grenades, one **vibro-blade** of choice, and one ancient weapon.

**Money:** 3D6×1000 credits' and 4D4×1000 credits worth of black market salable items. As a freelance spy or assassin, a character of good reputation with experience (4th level or higher) can charge, and get, anywhere from 4000 to 10,000 credits per single day operation!

**Cybernetics:** The modern ninja character starts with **cyber-armor** and 1D4 implants of choice, plus a tracer chip (see below) used by the clan to keep track of the character. Additional implants must be purchased by the character.

**Note:** Also see the ninja 'borg, below.

---

## Ninja Juicer

---

H-Brand and a few other corporations have turned to the illegal and deadly Juicer conversion technologies to create a shadow army of lethal assassins. Unlike the American juicers, ninja juicers are not desperate, insane, or power-hungry. Instead, most are raised from childhood in special training camps (the same training camps where normal tech-ninja, crazies and 'borgs are raised), and are told that their duty is to serve until the time of their premature death.

At some point between the ages of 14 and 18 (the character may have performed some missions as a normal ninja before then), candidates with the right physical and psychological conditions are selected for juicer conversion. Typically, the chosen candidates are dedicated, not overly bright (typically have an I.Q. 8-12) and fanatically loyal. These young men and women are taught to believe that to die at a young age is a glorious destiny: "the brightest flame is also the shortest lived," is the motto of the juicer ninja. Meditation techniques and breathing exercises are taught for years in preparation for the juicer treatment. These exercises and body conditioning extend the life of the juicer (death is inevitable, but the typical ninja juicer lives 6 years plus 2D6 months after the transformation) and reduce the manic, stressed-out state that juicers suffer due to their constant use of stimulants.

Raising each of these ninja juicers is a hugely expensive undertaking (well over three million credits, including the conversion operation). Most corporations will try to get their money's worth from these unstoppable warriors. Juicers are never used as cannon fodder unless they are in their last months of life. In fact, about 10% of the juicers who survive three years and prove themselves to be valuable assets (by performing daring and difficult missions, showing bravery and utter loyalty, etc.) are rewarded by undergoing *Juicer Detoxification* (see *Rifts*, pp. 69-70) and being transformed into ninja 'borgs (see below)!

Typically, teams of 1D6 ninja juicers (or mixed teams of juicers, crazies and 'borgs) will assist regular tech-ninja in assassinations, raids, military sabotage and similar missions. Although trained in the arts of subterfuge, the juicer is never expected to fool normal people for more than a few hours; the need to have a dispensary harness, the heightened reflexes of the character (who will sometimes react violently to any sudden movements, no matter how innocent) and the number of implants that can be detected under close inspection make long-term infiltration impossible.

The juicers live in remote camps where they spend their free time training and playing as only juicers can (watching a baseball game played by juicers can be a highly entertaining and mildly terrifying spectacle!). When a mission needs "the juicer touch," the team or selected individual is briefed, given weapons and equipment, and sent to contact the other agents at the mission site. Almost invariably, these missions involve violence or the possibility of violence; the juicers act under the orders of a tech-ninja, and act as bodyguards, enforcers and strike teams.

Very rarely, a juicer will rebel against his/her former masters. On those rare occasions, the escapee will be marked for death by his former clan, and termination teams, often made up of his fellow juicers, will be

sent after him. A player characters attempt to escape his fellow ninja (which would of course drag the rest of the player characters into conflict with that clan) could turn into a series of adventures or an entire campaign!

**Note:** H-Brand and Ichto periodically offer the basic ninja-juicer package to mercenaries, criminals and people who can afford it, without the years of ninja training. These characters dress in black and call themselves ninja, but they are not members of any ninja clans and are not offered the opportunity to detox or 'borg conversion — and are usually called "freelance assassins" by the ninja. Furthermore, they suffer from all the usual penalties the same as the American juicer (the ninja juicer does not because of years of meditation and training). In many instances, the character is required to spend 2 or 3 years in the Otomo Army (or other service) as part of the *payment*.

---

## Juicer Powers

---

Unless otherwise noted, these powers are identical to the powers listed in the *Rifts RPG*, p. 69.

**1. Super Endurance:** As the American juicer. Add 1D4×100 S.D.C., 1D4×10 to hit points, and 2D6 to P.E. attribute.

**2. Super Strength:** Slightly less than the regular juicer's. Strength is traded for superior balance and stealth. Add 2D4+2 to P.S. attribute. Minimum P.S. is 20; if lower, adjust up to P.S. 20.

**3. Super Speed:** As the American juicer. Add 2D4×10 to speed attribute.

**4. Super Reflexes and reaction time:** As the American juicer. Add 2D4 to P.P. attribute (minimum P.P. 20), +4 to initiative, +4 to roll with punch, fall or impact; add two attacks per melee, gets automatic parry or dodge on all attacks, even from behind. Reduced Penalties: Although the penalties for super reflexes do apply, meditation and breathing exercises can lessen and hide them for a while; the juicer can appear to be a normal, relaxed person for 10 minutes for every point of Mental Endurance (M.E.) he has. So, for example, a juicer with M.E. 12 could pretend to be calm and relaxed for 120 minutes (two hours), before pent-up tension betray him as a juicer (or, at least, a very manic individual, which can be strange under most circumstances in Japanese society).

**5. Enhanced Balance and Stealth:** Drug-enhanced sense of balance allows the ninja juicer to perform incredible acrobatic feats, and move with incredible quietness. The juicer can hold his breath for as long as five minutes without penalties, even while running or fighting, preventing even that small noise from giving him away! The character's ultra-light touch also allows him to walk over rice paper without breaking it, stride across a narrow beam or tightrope as easily as if he was walking on solid ground, and is never made dizzy or afraid by height or sudden movements. Add +15% to the climbing, acrobatics, and prowl skills (not counting O.C.C. bonuses). If those skills are not taken, the juicer has them automatically at 45%, +2% per level of experience! Penalties: The juicer cannot turn his grace and silent movement off; his quietness will tend to startle and scare people around him (can sneak behind most people automatically, which will make most civilians suspicious and afraid).

**6. Saving throw bonuses:** Identical to American Juicer.

**7. Enhanced Healing:** Same.

**8. Player's Note:** The juicer character will die after 6 years plus 2D6 months after the conversion takes place. Only *Juicer Detoxification* (see *Rifts RPG*, pages 69-70) can help. About one-tenth of loyal Ninja affiliated to the clan are transformed into 'borgs after three years of service; the rest live out their lives as juicers. Only renegades will attempt to undergo the detoxification process without the consent of their clan (renegades are hunted down and killed).

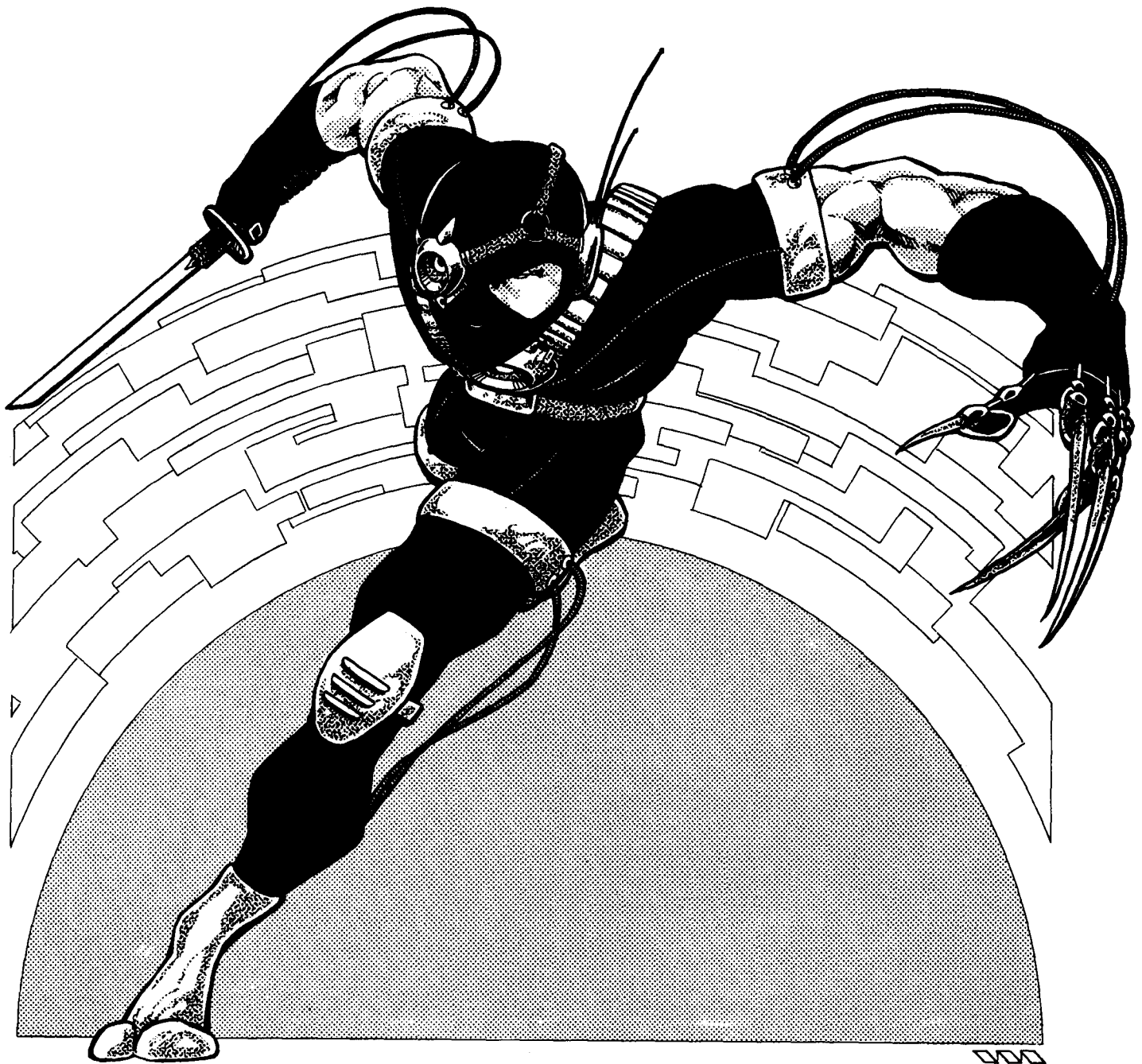

## Ninja Juicer

**Attribute Requirements:** None, just a willingness to submit to deadly chemical bombardment and dependency.

### O.C.C. Skills:

Mathematics: Basic (+10%)  
 Language: Japanese (+15%)  
 Literacy: Japanese (+10%)  
 Imitate Voice and Impersonation (+8%)  
 Climbing (+10%)  
 Prowl (+10%)  
 Disguise (+8%)  
 W.P. Four of choice

Hand to Hand: Assassin (see *Rifts RPG*).

Note: Hand to hand: assassin can also be replaced with aikido, jujitsu or karate at no cost. Ninjitsu is not available.

**O.C.C. Related Skills:** Select seven other skills, but at least two of these skills must be from the rogue category. Plus select an additional skill at levels four, eight, and twelve. All new skills start at level one proficiency.

Communications: Any (+5%)

Domestic: Any

Electrical: Basic Electronics only

Espionage: Any (+10%)

Mechanical: Basic and automotive mechanics only

Medical: First aid only

Military: Any(+10%)

Physical: Any (+10% where applicable)

Pilot: Any

Pilot Related: Any (+5%)

Rogue: Any (+10%)

Science: Basic Math only (+10%)

Technical: Any

Weapon Proficiencies: Any

Wilderness: Any (+5%)

**Secondary Skills:** The character also gets to select six secondary skills from the previous list. These are additional areas of knowledge that do not get the advantage of the bonus listed in the parentheses. All secondary skills start at the base skill level. Also, skills are limited (any, only, none) as previously indicated in the list.

**Standard Equipment:** A suit of personalized, mega-damage body armor, most will use **IA-100** Infiltrator Body Armor (M.D.C. 60). Several nondescript sets of clothing and disguises, rubber-soled tabi boots, and a black or camouflage ninja suit. Also a portable compact disc recorder/player and headphones, video disc player, micro-film camera (fits in the palm of the hand), pen flashlight, large flashlight, basic tool kit, utility belt, backpack, air filter and gas mask, tinted goggles, canteen, 50 feet (15.2 m) of knotted rope, grappling hook and one Ninja Emergency Kit. Plus bio-comp and bio-data implants, drug harness (Especially designed to be less bulky and obtrusive than common harnesses), and portable **IRMSS**kit.

The character starts with two energy weapons of choice, 4 extra **E-clips** for each, two vibro blades of choice (may include vibro-nail glove depicted on the drawing, inflicts 3D4 M.D.), choice of two non-energy weapons, and three ancient weapons.

**Money:** 1D6×1000 credits and 2D4×1000 credits' worth of black market salable items. More money may be provided by the clan depending on the mission. All living expenses are taken care of by the clan; the Ninja spends most of his life in special hidden camps and headquarters.

**Cybernetics:** Start with only one; a tracer chip (see cybernetics section) used by the Clan to keep tabs on the ninja. The clan may order the juicer to accept one or two special implants (usually not until second or third level), but otherwise, most juicers will not choose implants, preferring to rely on their natural abilities.

---

## Ninja Crazy

---

A number of tech-ninja clans rely on M.O.M. implants to produce modern-day equivalents of the warriors of old. Like the juicers, ninja crazies are selected from among young ninja trainees who have been raised in special camps away from the outside world (see the *Tech-Ninja O.C.C.*). The candidates are chosen for their high mental endurance (M.E.) and intelligence, and they are trained in meditation techniques to help them overcome the inevitable insanities that are caused by M.O.M. implants. Latent or minor psychics are also preferred, and their powers are developed and enhanced. As a result, the ninja crazies are better able to resist their mental shortcomings than ordinary, untrained characters. They also have twice as many psionic powers as normal crazies, which enables them to compete with the traditional ninja in the mystic field.

Crazies are used in a variety of missions. They are expert thieves, specializing in all kinds of breaking and entering techniques, from cat-burglary to safe-breaking and demolitions. When something needs to be stolen, paired teams of tech-ninjas and ninja crazies are sent out to get it. Additionally, they use their psychic abilities for a number of special missions, from eavesdropping (via astral travel or telepathic contact) to deceit (passing themselves off as dead through death trance, or hiding

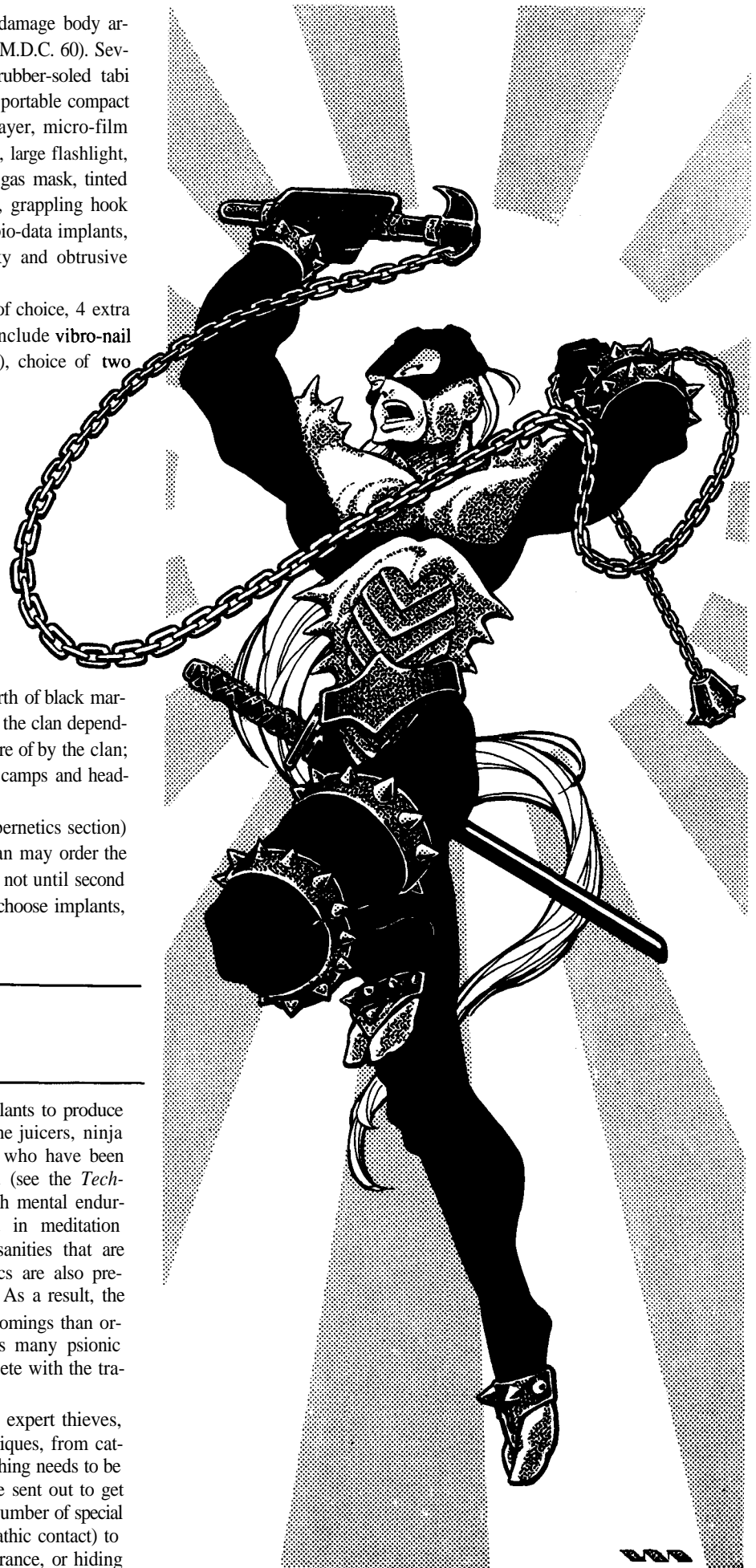

their powers through alter aura). This combination of psychic powers and thief abilities make them highly valued specialists.

Their secondary specialty is combat and assassination. They are considered to be in the third rank for such missions; the first rank combat ninja are 'borgs, the second rank juicers, the third rank crazies and the last, fourth rank, are normal tech-ninja. Depending on the severity of the mission, different ranks are assigned. Assassinating a hatchling dragon, for example, is considered to be a **first-and** second-rank job; crazies assigned to the mission would be assigned to support tasks, while the main attack would be carried out by 'borgs and juicers.

Long-term undercover and infiltration jobs are impossible, both because of the easily visible M.O.M. implants (the implants can be hidden for short periods of time by wigs, hoods, hats and helmets) and the sometimes erratic behavior of **unsupervised** crazies. Each crazy is usually assigned a tech-ninja trained in psychological techniques; usually a friend of the crazy who trained with him side by side. This "buddy" will help calm down the crazy during one of his episodes, and will also keep an eye out for him. These paired teams are seldom split up, and are always sent out on missions together.

If a **crazy's** sanity starts to slip away to the point that he is no longer useful, he is eliminated. This decision is usually made by the Jonin or Ninja master, and only if the character becomes a threat to the success of future missions or the secrecy and survival of the clans. A combination of therapy and meditation techniques often allows the crazy to function normally for extended periods; when they are in the protection of the tech-ninja safe-houses (usually hidden in mountain fortresses, remote islands, deep valleys, or in deep underground complexes beneath a city), their insanities are allowed full reign, provided they do not lead to the ninja getting hurt.

## Crazy's Powers

Unless otherwise noted, the powers of the ninja crazy are identical to those of the American crazy (see *Rifts RPG*, page 56).

**1. Super Endurance:** Identical to American crazy powers. Add 3D6xIO to S.D.C., 5D6 to Hit Points and +1D6 to P.E.

**2. Increased Strength:** Same as American crazy. +2D4 to P.S. (minimum 19).

**3. Increased Speed:** Same as American crazy (+4D6 to Speed).

**4. Heightened Reflexes, agility and senses:** The combination of training and physical capabilities produces the following bonuses: +4 to roll with punch, fall or impact, +2 on initiative, add one extra attack per melee. Enhanced grace, silent move, and balance: add +12% to climbing, prowl and acrobatics (in addition to O.C.C. bonuses). Also add 1D6 to P.P. attribute (minimum P.P. 17).

Enhanced vision, smell, and touch: equal to American crazy. Add +10% to skills requiring a delicate touch, including all demolition skills, pick pockets, pick locks, palming, electronics, etc.

**5. Saving Throw Bonuses:** Same as American Crazy.

**6. Enhanced healing:** Same as American Crazy.

**7. Bio-regeneration:** Same as American Crazy.

**8. Major Psionics:** Select six psionic powers from the sensitive and physical categories (can choose from both or either, and has no exceptions). Greater psionic abilities than normal crazies.

**9. Delusions and Insanities:** The **ninja crazy** suffers the same problems as the American crazy, but meditation and therapy allows them to control their insanities for 3D4 days at a stretch (G.M.s, roll in secret so the player does not know how long his character has). At the end of that period, a save vs psychic attack/insanity (the **ninja crazy** has a cumulative bonus of +1 at levels 3, 5, 8 and 10, plus M.E. bonuses) is necessary, at a -1 cumulative penalty for every day spent without returning to meditation and therapy (meditation and therapy take over twelve hours a day, impossible to do during a mission). The save must be made for EACH insanity/delusion. So, for example, a 7th level crazy will be at +2 to save, but must make four rolls, once for each insanity! A failed

save means that the delusion has full force; this may or may not have an effect on the mission (role-play it!).

**Attribute Requirements:** M.E. of 14 or higher. Ninja crazy candidates are chosen for their strong will, psionic potential and resistance to insanity.

### O.C.C. Skills:

Mathematics: Basic (+10%)

Language: Japanese (+20%)

Literacy: Japanese (+15%)

Computer Operation (+5%)

Computer Programming (+5%)

Computer Hacking (+10%)

Climbing (+10%)

Prowl (+10%)

Pick Locks (+10%)

Demolitions (+10%)

W.P. Three of choice

Hand to Hand: Assassin

Hand to hand: assassin can also be replaced with aikido, jujitsu or karate at no cost. Ninjitsu is not available.

**O.C.C. Related Skills:** Select eight other skills, but at least two of these skills must be from the rogue category. Plus select an additional skill at levels four, eight, and twelve. All new skills start at level one proficiency.

Communications: Any

Domestic: Any

Electrical: Basic Electronics only.

Espionage: Any (+10%)

Mechanical: Basic, automotive mechanics and locksmith only (+10%) on locksmith).

Medical: First aid and criminal sciences & forensics only (need prerequisites under science).

Military: Any (+10%)

Physical: Any (+5% where applicable)

Pilot: Any

Pilot Related: Any (+5%)

Rogue: Any (+12%)

Science: Any

Technical: Any

Weapon Proficiencies: Any

Wilderness: Any (+5%)

**Secondary Skills:** The character also gets to select six secondary skills from the previous list. These are additional areas of knowledge that do not get the advantage of the bonus listed in the parentheses. All secondary skills start at the base skill level. Also, skills are limited (any, only, none) as previously indicated in the list.

**Standard Equipment:** A suit of personalized, mega-damage body armor, most will use **IA-100** Infiltrator Armor (M.D.C. 60). Several nondescript sets of clothing and disguises, rubber-soled tabi boots, and a black or camouflage ninja suit. Also a hand-held computer, portable compact disc recorder/player and headphones, video disc player, micro-film camera (fits in the palm of the hand), pen flashlight, large flashlight, lock picking tools, small crowbar, basic tool kit, utility belt, backpack, air filter and gas mask, tinted goggles, canteen, 50 feet (15.2 m) of knotted rope, grappling hook and one Ninja Emergency Kit.

**Note:** The equipment section has descriptions of other specialized ninja equipment. It is up to the game master to determine whether or not a ninja character should start with any additional special equipment.

The modern ninja places an emphasis on the use of technology, especially in the areas of equipment and weapons. The character starts with one energy weapon of choice (typically a small pistol or small concealed weapon), 4 extra **E-clips**, one **vibro-blade** of choice, and one ancient weapon.

**Money:** 2D6×1000 credits and 1D4×1000 credits' worth of black market salable items. The clan may provide more money as needed for a mission. All living expenses are taken care of by the clan; the ninja spends most of his life in special hidden camps and headquarters.

**Cybernetics:** Starts with only one: a tracer chip (see new cybernetics and bionics) that the clan uses to keep tabs on the ninja. Additional implants must be purchased by the character.

## Ninja 'Borg

Ninja 'borgs are the deadliest assassins in the tech-ninja clans. Able to withstand as much damage as a soldier in power armor, and equipped with a lethal array of implanted weaponry, these cybernetic warriors can kill most targets with impunity. Furthermore, the technicians from such corporations as **Ichto** and **H-Brand** have developed a number of unique, special bionic implants that greatly enhance the ninja 'borgs' stealth and surveillance capabilities, making them equally valuable as silent killers and spies.

Like all other tech-ninjas, most 'borgs grow up in a special training camp. Most of those chosen for *total conversion* are usually characters with inferior physical qualities (including disabled or handicapped youngsters) who still have the zeal and loyalty the clan expects in their members. The selected members then undergo the conversion process, usually at age 18. The previous years are spent training in complex computer simulations to prepare the candidates for their new life as living machines.

The ninja is then "gifted" with a mechanical body. Only the face, the brain and a few organs remain human. A number of options are given to the cyborg, varying with the qualifications and psychological profile of the character. Such accessories as extra limbs, cybernetic tail and fire-breathing apparatus (see below) are only added on if the character is psychologically able to accept such inhuman modifications. Most ninja 'borgs are built to appear as **humanoid** as possible, mostly to allow the ninja to be unnoticed, if only at a distance. Disguising the metallic structure of the cyborg body is only possible for short periods of time, and involves hiding under trench coats, cloaks, capes, robes and other bulky clothing, wearing hats and dark glasses to conceal bionic eyes or head implants, and similar tactics. This will conceal the 'borg only from casual contact (5% chance per ten minutes of being recognized as a 'borg while walking through a busy street). Most 'borgs, like juicers and crazies, are only sent out of their enclaves to perform short-term missions (a quick recovery, kidnapping or assassination, for example).

'Borgs are also used extensively, along with juicers, in military missions. Tech-ninjas are sometimes used as mercenary elite troops by some of the kingdoms that buy weapons (or rent warriors) from **H-Brand** and similar corporations. Military missions include sabotage of supply lines, the assassination of military leaders, ambushes of armored columns, and the destruction of bridges and roads. These missions are much more dangerous than common corporate espionage and city capers; the enemy is fully equipped with magical and technological weapons, and even ninja cannot hope to beat large numbers of well-equipped enemies. Ninja 'borgs have still managed to earn a dreaded reputation in such missions, successfully completing them despite overwhelming enemy attacks. Even such warriors as the true samurai have learned to respect these silent metal juggernauts.

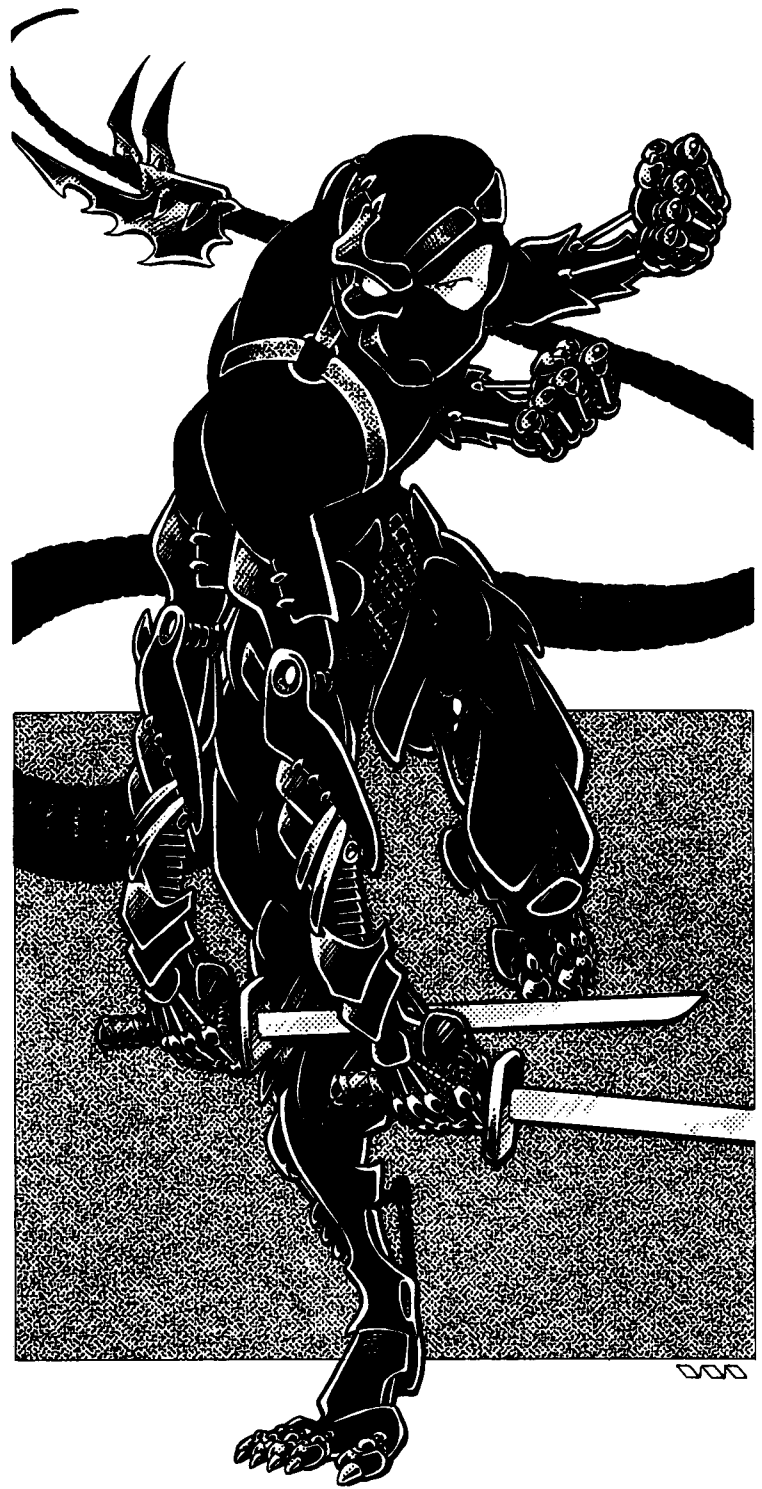

### Bionic Conversion & Accessories

**1. Full Bionic Conversion:** All ninja 'borgs undergo full bionic conversion. The maximum possible strength and prowess are provided. M.D.C.: 280, P.P. 24, P.S. 30, Speed 176 (120 mph/182 kph). The cyborg has a sense of touch of only 43%, and prowl has a -40% penalty (but see below).

**2. Sound Suppression System:** This is an advanced version of some pre-Rifts measures used to control sound pollution. A sound emitter is built alongside the skin of the cyborg (will only work if the 'borg is wearing light M.D.C. armor; heavy cyborg armor will muffle the emitter). The emitter then sends out sound waves in exactly the opposite frequencies as the noises made by the 'borg, neutralizing them. Human ears cannot sense the sounds; additionally, special rubber soles and joints contribute to the reduced sound: the common prowl penalty is

eliminated when using these two systems! **Restrictions:** The 'borg must be moving or climbing slowly (a speed of 10 maximum); sudden movements will bring back the full -40% penalty. And the character must wear the light M.D.C. armor.

**3. Standard Bionic Accessories:** All ninja 'borgs have the following accessories: multi-optic eye (one or two), amplified hearing, and motion detector, bionic lung, climb cord, **garrote** wrist wire, concealed laser rod (1D6 M.D.), retractable **vibro-blades** (2D6 M.D.) and concealed particle beam (6D6+6 M.D.; range 1000 feet/305 m; built into torso; a sliding plate opens up to unmask the gun; armor can be built to slide alongside the chest panel).

**4. Optional Bionic Accessories:** Some (30%) of all ninja 'borgs have one or more of these enhancements: modulating voice synthesizer, chemical spray, additional arm, additional tail appendage, or fire-breath system (see below).

**5. Bionic Fire-breath System (New):** A unique weapon consisting of a plasma discharger built into the mouth! An **E-clip** (in body compartment; can be easily replaced) powers the weapon. The plasma is discharged through the mouth, inflicting 1D4×10 M.D. (range: 500 feet/152 m). The main drawback is that the lower mouth must be fully replaced by metal, and the voice box has to be heavily armored. As a result, the voice has an eerie, inhuman deepness (Horror Factor of 9, and clearly abnormal).

## Ninja 'Borg O.C.C.

**Attribute Requirements:** M.E. 12. There are no physical requirements; in fact, most ninja 'borgs are either disabled or former juicers who have successfully undergone detoxification.

### O.C.C. Skills:

Mathematics: Basic (+10%)  
Radio: Basic (+15%)  
Radio: Scrambler (+10%)  
Language: Japanese (+20%)  
Literacy: Japanese (+15%)  
Computer Operation (+5%)  
Climbing (+10%)  
Prowl (+10%)  
Detect Ambush (+10%)  
Track (+10%)  
W.P. Four of choice  
Hand to Hand: Assassin

**O.C.C. Related Skills:** Select six other skills, but at least one of these skills must be from the rogue category. Plus select an additional skill at level four, one at level eight, and one at level twelve. All new skills start at level one proficiency.

Communications: Any (+5%)  
Domestic: Any  
Electrical: Basic Electronics only  
Espionage: Any (+10%)  
Mechanical: Basic and automotive mechanics only  
Medical: First aid and criminal sciences and forensics only (need prerequisites under science).  
Military: Any (+10%)  
Physical: Any  
Pilot: Any  
Pilot Related: Any (+5%)  
Rogue: Any (+6%)  
Science: Any  
Technical: Any  
Weapon Proficiencies: Any  
Wilderness: Any (+5%)

**Secondary Skills:** The character also gets to select six secondary skills from the previous list. These are additional areas of knowledge that do not get the advantage of the bonus listed in the parentheses. All secondary skills start at the base skill level. Also, skills are limited (any, only, none) as previously indicated in the list.

**Standard Equipment:** A suit of personalized, mega-damage body armor, most will use **NF-100** Infiltrator. Several nondescript sets of clothing and disguises, rubber-soled **tabi boots**, and a black or camouflage ninja suit. Also a hand-held computer, portable compact disc recorder/player and headphones, video disc player, micro-film camera (fits in the palm of the hand), pen **flashlight**, large flashlight, lock-picking tools, small crowbar, basic tool kit, utility belt, backpack, air filter and gas mask, tinted goggles, canteen, 50 feet (15.2 m) of knotted rope, grappling hook and one Ninja Emergency Kit.

**Note:** The equipment section has descriptions of other specialized ninja equipment. It is up to the game master to determine whether or not a ninja character should start with any additional special equipment.

The modern ninja places an emphasis on the use of technology, especially in the areas of equipment and weapons. The character starts with one energy weapon of choice, 4 extra **E-clips**, one **vibro-blade** of choice, and one ancient weapon.

**Money:** 1D6×1000 credits and 1D6×1000 credits' worth of black market salable items. The clan may provide more money as needed for a mission. All living expenses are taken care of by the clan; the Ninja spends most of his life in special hidden camps and headquarters.

**Cybernetics:** In addition to the bionic systems described above, the Ninja 'Borg can have an additional 1D4 cybernetic systems of choice, plus a tracer chip used by the clan to keep track of the character.

---

# Ninja Techno-Wizard O.C.C.

---

The art of **techno-wizardry** is all but unknown in Japan. The division between sorcery and science is too intense on the island; each side distrusts, fears and even hates the other, and alliances between the two are frowned upon by the authorities of most nations. Only the ninja, who rarely work within the law, and who care little about approval, have dared to meddle in this field. As a result, they have a monopoly on techno-wizardry in Japan!

The art of techno-wizardry first appeared in the Otomo Shogunate, when the ninja clan associated with H-Brand started to experiment with a combination of magic and science. The tech-ninja were trying to mix the two in an attempt to match the feats of the mystic ninja. The drive followed a particularly nasty defeat; a group of "true" ninja had ambushed and killed a tech-ninja team that included juicers and 'borgs. Looking for a means of revenge, the ninja scientists and an Otomo band of sorcerers worked day and night, and, in 99 P.A., they managed to develop techno-wizardry, independently of similar discoveries elsewhere.

There are still very few Ninja **Techno-Wizards** in Japan; less than 1% of all tech-ninja ever learn to manipulate magic and technology. Still, the few who have learned these secrets have become incredibly successful. **TW** ninjas equipped with armor enchanted with the superior invisibility spell were able to perform a number of very difficult missions without any problems, and in a revenge encounter against the mystic ninja clan, the **TW** magic devices turned the tide for the tech-ninja.



These specialists are trained in the field of magic and assassination simultaneously. The few students who show an aptitude for magic are subjected to the most rigorous training in the ninja camps. This has led to the creation of some highly accomplished magicians. Nevertheless, these handful of elite techno-wizards often feel angry and frustrated, worked like dogs and seldom given the opportunity for adventure. Consequently, some members of this tiny, disgruntled group plot to abandon and even betray the clan.



## Powers of the Ninja Techno-Wizard:

### Also known as the TW Ninja

Unless otherwise noted, these powers are identical to those of the techno-wizard O.C.C., described in the *Rifts RPG*, pages 89-90.

1. **Psionic Powers:** Identical to the regular techno-wizard.
2. **Initial Spell Knowledge:** Penalties are as per the techno-wizard. All level one spells remain unchanged, but only two more spells are learned at level three.
3. **Learning New Spells:** Other spells can be purchased or learned, but the character is limited by the general lack of magic knowledge in the area; only the clan can provide magical teachings, and it decides what spells will be taught next. **Note:** The G.M. decides which spells the clan decides to teach the TW ninja. Trying to learn spells elsewhere without the express consent of the clan is considered to be treason and punishable by death!
4. **Magic Bonuses:** +2 to save vs horror factor, +1 to save vs magic at levels four, seven, eleven and fourteen. +1 to spell strength at level five, nine, and thirteen.
5. **P.P.E.:** Like all men of magic, the ninja techno-wizard is a living battery of mystic energy. Permanent Base P.P.E.:  $1D6 \times 10 + 10$  plus the P.E. attribute. Add  $2D6$  P.P.E. per each additional level of experience.

## Techno-Wizard O.C.C.

**Attribute Requirements:** P.E. 12, I.Q. 12, and M.E. 12 or higher.

### O.C.C. Skills:

Mathematics: Basic (+15%)  
 Language: Japanese (+20%)  
 Literacy: Japanese (+15%)  
 Computer Operation (+5%)  
 Computer Programming (+5%)  
 Computer Hacking (+10%)  
 Computer Repair +10%)  
 Basic Electronics (+10%)  
 Automotive Mechanics (+10%)  
 Carpentry (+8%)  
 Palming (+5%)  
 Prowl (+8%)  
 Disguise (+5%)  
 W.P. Two of choice

Hand to Hand: Expert (see *Rifts RPG*)

Hand to hand: expert can be changed to hand to hand: assassin, martial arts or aikido at the cost of one "other" skill, or to karate or jujitsu at the cost of two "other" skills.

**O.C.C. Related Skills:** Select seven other skills, but at least one of these skills must be from the rogue or espionage categories. Plus select one additional skill at levels four, eight, and twelve. All new skills start at level one proficiency.

Communications: Any (+5%)

Domestic: Any

Electrical: Any, but each skill counts as two skill selections.

Espionage: Any (+5%)

Mechanical: Any, but each skill counts as two skill selections.

Medical: First aid and criminal sciences and forensics only (need prerequisites under science).

Military: Any (+5%)

Physical: Any except acrobatics.

Pilot: Any (+5%)

Pilot Related: Any (+5%)

Rogue: Any (+5%)

Science: Any (+8%)

Technical: Any (+10%)

Weapon Proficiencies: Any

Wilderness: Any

**Secondary Skills:** The character also gets to select two secondary skills from the previous list at levels one, four, eight and twelve. These are additional areas of knowledge that do not get the advantage of the bonus listed in the parentheses. All secondary skills start at the base skill level. Also, skills are limited (any, only, none) as previously indicated in the list.

**Standard Equipment:** A suit of personalized, mega-damage body armor, most will use **IA-100** Infiltrator Armor (60 M.D.C., concealed **vibro-blades** inflict 2D4 M.D.); this armor can have two techno-wizard magic features of the character's choice, excluding impervious to energy (can have invisibility). Several nondescript sets of clothing and disguises, rubber-soled tabi boots, and a black or camouflage ninja suit. Weapons may include one converted energy weapon (uses P.P.E. instead of normal energy), an additional energy pistol, and 1D4 extra E-clips.

Also a hand-held computer, portable compact disc recorder/player and headphones, video disc player, micro-film camera (fits in the palm of the hand), pen flashlight, large flashlight, lock-picking tools, small crowbar, basic tool kit, utility belt, backpack, air

filter and gas mask, tinted goggles, canteen, 50 feet (15.2 m) of knotted rope, grappling hook and one Ninja Emergency Kit.

The character starts with one energy weapon of choice (typically a small pistol or small concealed weapon), 4 extra **E-clips**, one **vi-bro-blade** of choice, and one ancient weapon.

**Money:** 3D6×1000 credits and 4D4×1000 credits' worth of black market salable items. As a freelance spy or assassin, a character of good reputation with experience (4th level or higher) can charge, and get, anywhere from 4000 to 10,000 credits per single day operation!

**Cybernetics:** The modern ninja character starts with **cyber-armor** and 1D4 implants of choice, plus a tracer chip used by the clan to keep track of the character. Additional implants must be purchased by the character.

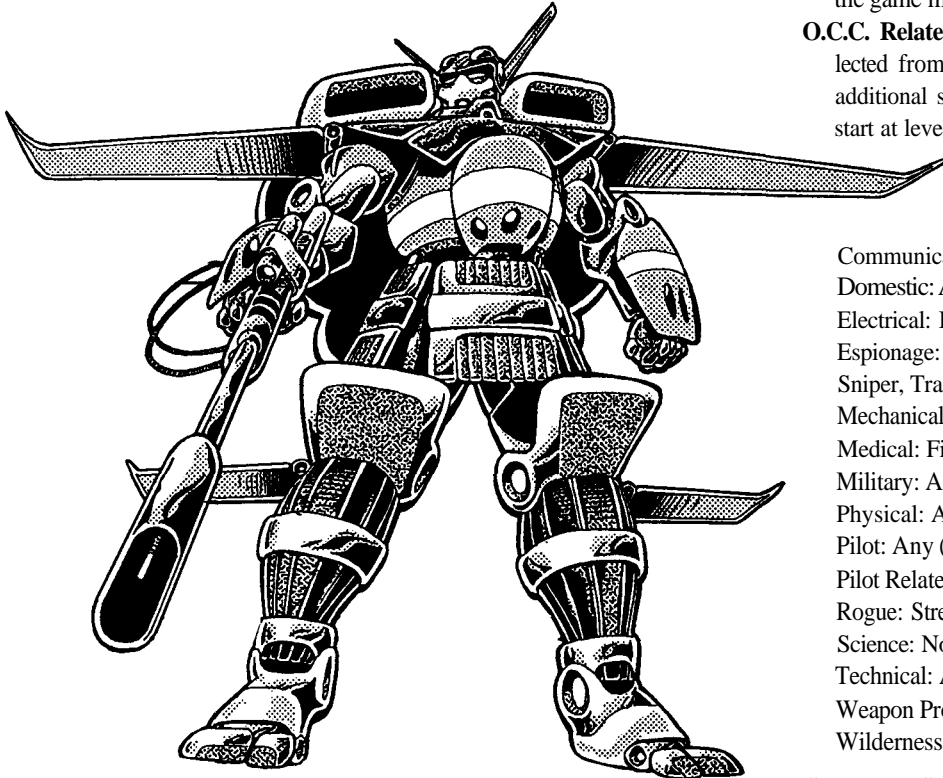

## SAMAS Samurai Pilot

This is the elite Robot Power Armor (RPA) pilot of the Republic's Armed forces. The SAMAS is a versatile, powerful power armor system, superior to the Coalition's version of this earlier design. Unlike the CS pilots, however, the samurai pilots are dedicated, compassionate warriors who respect all life and are not intoxicated by the power and authority that come with the job. Like their name indicates, these pilots live by a code inspired by the Bushido (Way of the Warrior) of the true samurai. Although more modern and less formal than the traditional warriors of the New Empire, the courage and dedication of these pilots in the face of monsters and supernatural threats have earned them the respect of even the mystic warriors of magic Japan.

Together with the Glitter Boy Force, the SAMAS pilots represent 50% of the Republic's defenders. They also serve on the police force and are excellent for quick response and maneuverability in an urban setting. The pilots are also qualified to pilot or drive a number of other vehicles, allowing them to participate in a number of different missions.

**Attribute Requirements:** I.Q. 10 and P.P. 11 or higher.

**O.C.C. Skills:**

- Streetwise (+4%)
- Basic Mathematics (+10%)

- Language: Japanese & American (+20%)
- Literacy: Japanese & American (+15%)
- Computer Operation (+10%)
- Radio: Basic (+10%)
- Pilot Tanks & APCs (+10%)
- Pilot Robots & Power Armor (+10%)
- Power Armor Combat Elite: SAMAS Samurai
- Robot Combat: Basic
- W.P. Energy Rifle
- W.P. Blunt (**nightstick/stun clubs**)
- Hand to Hand: Expert (see *Rifts RPG*)
- Hand to hand: expert can be changed to martial arts, or assassin if evil, at the cost of one "other" skill selection. To change to jujitsu, at the game master's discretion, the cost is two "other" skill selections.
- O.C.C. Related Skills:** Select seven other skills, but two must be selected from pilot and two from pilot related skills. Plus select one additional skill at levels three, six, nine and twelve. All new skills start at level one proficiency.

- Communications: Any (+10%)
- Domestic: Any
- Electrical: Basic Electronics only
- Espionage: Detect Ambush, Detect Concealment, Interrogation, Sniper, Tracking & Wilderness only (+5%)
- Mechanical: Basic only
- Medical: First Aid only (+5%)
- Military: Any (+15%)
- Physical: Any, except acrobatics
- Pilot: Any (+10%)
- Pilot Related: Any (+10%)
- Rogue: Streetwise only
- Science: None
- Technical: Any (+10%)
- Weapon Proficiencies: Any
- Wilderness: Any

**Secondary Skills:** The character also gets to select three secondary skills from the previous list at levels one, five and ten. These are additional areas of knowledge that do not get the advantage of the bonus listed in the parentheses. All secondary skills start at the base skill level. Also, skills are limited (any, only, none) as previously indicated in the list.

**Standard Equipment:** Kuru or "Trooper" body armor, AT-N20 neural stick, energy rifle and energy **sidearm** of choice, four extra E-clips for each, four AT-D30 **stun/flash** grenades or tear gas, two signal flares, survival knife, utility belt, dress uniform, field uniform (includes combat boots), survival kit (canteen, gas mask, radio, 1 week's worth of rations, fishing line and hooks, and first-aid kit), and two non-energy weapons of choice. SAMAS is provided for field use only.

**Upon Special Assignment:** Access to SNARLS sensor system, AT-ADD Anti-Armor Dissolving grenades, other types of grenades, rifles and heavy weapons and other equipment may be made available to elite troops and in emergency situations.

**Money:** Room and board are provided by the military at no cost, plus the soldier has a starting salary of 2500 credits a month. Starts out with one **month's** pay.

**Cybernetics:** None to start; usually restricted to medical implants.

---

# Infantryman O.C.C.

---

These are the "ground pounders," the men and women who stand between the Republic of Japan and its myriad of enemies. Most (80%) of the infantry are citizens of Hiroshima, Kure and **Iwakuni**, survivors of the Great Cataclysm willing to die to defend their land. The remaining 20% are also volunteers, usually former peasant refugees who streamed into the newly-arrived cities after they were convinced the newcomers were not monsters or evil invaders. These peasant-soldiers have all been taught the rudiments of literacy and computer use, and are even more motivated than their fellow soldiers — they have seen the horrors that await the prosperous cities if they fail.

**Attribute Requirements:** P.E. 9. A high P.S. and P.P. are suggested but not required.

**O.C.C. Skills:**

Basic Mathematics (+10%)

Language: Japanese & American (+20%)

Literacy: Japanese & American (+20%)

Computer Operation (+10%)

Radio: Basic (+10%)

Pilot Tanks & APCs (+10%)

Read Sensory Equipment (+10%)

Weapon Systems (+10%)

Running

W.P. Energy Rifle

W.P. Energy Pistol

**W.P.:** One of choice.

Hand to Hand: Expert (see *Rifts RPG*)

Hand to hand: expert can be changed to martial arts/Judo, or assassin if *evil*, at the cost of one "other" **skill selection**. To change to **jujitsu**, at the game master's discretion, the cost is two "other" skill selections.

**O.C.C. Related Skills:** Select seven other skills. Plus select two additional skills and a W.P. at level three, two at level six, and one at levels nine, twelve and fourteen. All new skills start at level one proficiency.

Communications: Any (+5%)

Domestic: Any

Electrical: None

Espionage: Wilderness Survival only.

Mechanical: Automotive only.

Medical: First Aid only (+5%)

Military: Any (+15%)

Physical: Any, except acrobatics

Pilot: Any

Pilot Related: Any (+10%)

**Rogue:** Any

Science: None

Technical: Any (+10%)

Weapon Proficiencies: Any

Wilderness: Any (+5%)

**Secondary Skills:** The character also gets to select six secondary skills from the previous list. These are additional areas of knowledge that do not get the advantage of the bonus listed in the parenthesis. All secondary skills start at the base skill level. Also, skills are limited (any, only, none) as previously indicated in the list.

**Standard Equipment:** "Trooper" or Marine armor, energy rifle and energy pistol (typically A-30 laser pistol and AT-88 laser rifle), 4 E-

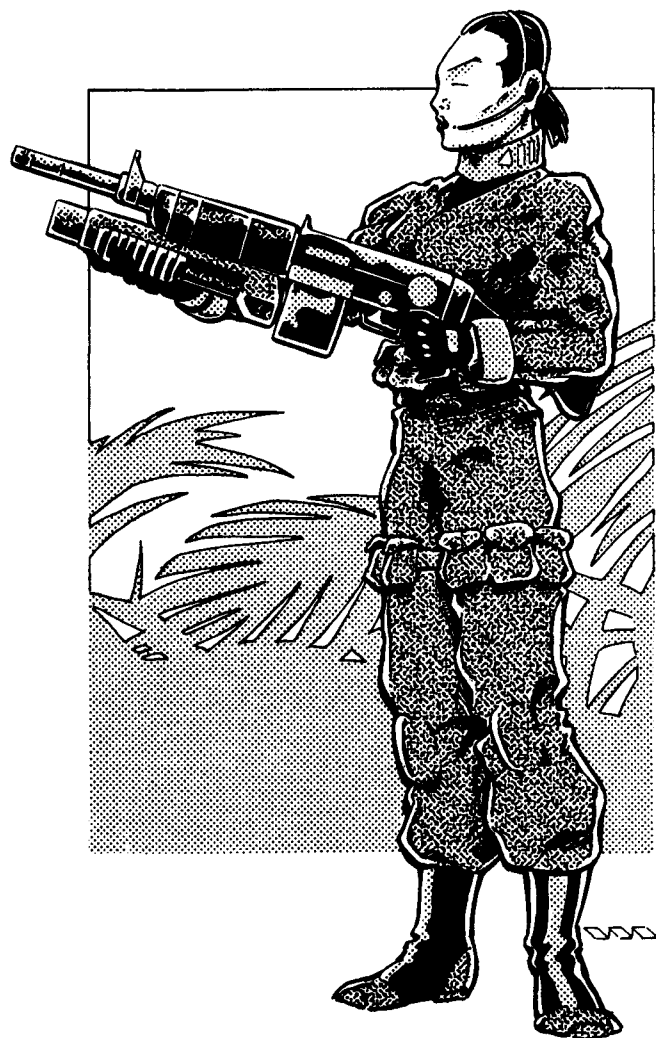

clips for each, armed forces personal backpack, parade uniform, and field uniform with combat boots. Additional equipment may be issued under special combat situations.

**Money:** Soldiers have free room and board plus a starting salary of 1800 credits a month. Starts with a month's salary in cash.

**Cybernetics:** 60% start with four of choice (no bionics), but are unlikely to get any others except as medical and prosthetic replacements, until after they get out of the service.

---

# Robot Pilot O.C.C.

---

These pilots specialize in the large humanoid war machines of the New Republic, but also learn to drive a number of other vehicles. They are the standard pilots of the Republic, not quite the elite troopers SAMAS Samurai and Glitter Boy pilots are, but still a group of highly-trained professionals with a good set of skills.

Robot pilots are highly respected by the population at large; given Japan's long-time fascination for giant war machines, these robot pilots are the living embodiments of **manga** "legends." TV shows, novels and comic books depicting the heroic adventures of robot pilots (as well as Glitter Boys and SAMAS Samurai) are very popular among the masses. This causes some resentment among the infantrymen, who see themselves as the guys taking the biggest risks (hey, they aren't protected by several inches of M.D.C. armor, after all), while the "robot boys" get all the glory. Brawls at military bars during leave time are frequent enough to warrant the formation of infantryman-only bars and robot pilot (and PA pilots)-only bars. One group does not frequent the other's bars unless they are looking for a fight!

**Attribute Requirements:** P.P. 10 or higher, I.Q. 9 or higher.

**O.C.C. Skills:**

Basic Mathematics (+10%)  
Language: Japanese & American (+20%)  
Literacy: Japanese & American (+10%)  
Computer Operations (+10%)  
Radio: Basic (+10%)  
Pilot Tanks & APCs (+10%)  
Pilot Robots & Power Armor (+10%)  
Robot Combat: Elite  
Robot Combat: Basic  
W.P. Energy Pistol  
W.P. Energy Rifle  
Hand to Hand: Expert

Hand to hand: expert can be changed to martial arts, or assassin if evil, at the cost of one "other" skill selection. To change to jujitsu, at the game master's discretion, the cost is two "other" skill selections.

**O.C.C. Related Skills:** Select eight other skills. Plus select one additional skill at levels three, six, nine and twelve. All new skills start at level one proficiency.

Communications: Any (+10%)  
Domestic: Any  
Electrical: None  
Espionage: Detect Ambush, Tracking & Wilderness only (+5%)  
Mechanical: None

Medical: First Aid only (+10%)  
Military: Any (+15%)  
Physical: Any, except acrobatics  
Pilot: Any (+5%)  
Pilot Related: Any (+10%)  
Rogue: Any  
Science: None  
Technical: Any (+10%)  
Weapon Proficiencies: Any  
Wilderness: Any

**Secondary Skills:** The character also gets to select six secondary skills from the previous list. These are additional areas of knowledge that do not get the advantage of the bonus listed in the parentheses. All secondary skills start at the base skill level. Also, skills are limited (any, only, none) as previously indicated in the list.

**Standard Equipment:** Energy pistol and rifle of choice, military personnel backpack, dress uniform, field uniform with combat boots, and two non-energy weapons of choice. Power armor and military vehicles are issued for field use only.

**Money:** Room and board are paid for by the military, and the pilots have a starting salary of 2000 credits. Start with one month's salary in cash.

**Cybernetics:** 50% have 1D4 cybernetic implants; may get some more later at his own expense.

---

## Glitter Force Trooper O.C.C.

While the Glitter Boys of North and South America are the heirs of a scarce, secret technology, and are independent adventurers and mercenaries of almost romantic dimensions, the Glitter Force Troopers of Japan are well-trained, professional soldiers. These pilots live, fight and die for one cause, the protection of the New Republic. They are an elite force, adored by the public and feared by Nippon's enemies, but they know that with their well-deserved reputation comes a great deal of responsibility. They tend to be more serious and driven than their American counterparts, although if they ever met each other, each side would learn to appreciate, respect, and understand the other.

These pilots are trained to work in teams of Glitter Boys, or in coordination with other robots, power armor and military vehicles. They have developed tactics that maximize their incredible firepower, while preventing enemies the ability to exploit the traditional Glitter Boy weakness: its low mobility. A common tactic consists of using lighter flying vehicles, such as the SAMAS Samurai, to "channel" enemy forces into a narrow area, concentrating the enemy in front of the Glitter Boys' guns and giving them excellent targets. More than one oni horde has met its doom in this manner.

In addition to specializing in Glitter Boys, these pilots also train extensively in all other robots and power armor, and can use any weapon system built by **Armatech** (and many from **Ichto** and **H-Brand**) with relative expertise. Due to their great range of skills, Glitter Force Troopers are sometimes used in less conventional missions, acting in special operations as military advisors, teachers and even secret agents!

Off-duty Glitter Boy pilots behave with a quiet, understated sense of superiority. They seldom boast or brag about their accomplishments; it is enough that others know they are Glitter Force Troopers, and therefore, the best there is.

**Attribute Requirements:** P.P. 11 or better.

**O.C.C. Skills:**

Basic Mathematics (+10%)  
Language: Japanese & American (+20%)  
Literacy: Japanese & American (+20%)  
Computer Operation (+10%)  
Radio: Basic (+10%)  
Pilot Robots & Power Armor (+10%)  
Robot Combat Elite: Glitter Boy  
Robot Combat: Basic  
Read Sensory Equipment (+15%)  
Weapon Systems (+10%)  
Running  
W.P. Energy Pistol  
W.P. Energy Rifle  
Hand to Hand: Expert

Hand to hand: expert can be changed to martial arts/judo, or assassin if evil, at the cost of one "other" skill selection. To change to kendo, karate or jujitsu, at the game master's discretion, the cost is two "other" skill selections.

**O.C.C. Related Skills:** Select six other skills. Plus select one additional skill at levels three, six, nine and twelve. All new skills start at level one proficiency.

Communications: Any (+10%)  
Domestic: Any  
Electrical: None  
Espionage: Detect Ambush, Detect Concealment, Interrogation, Sniper, Tracking & Wilderness only (+5%)  
Mechanical: None  
Medical: First Aid only (+10%)  
Military: Any (+15%)  
Physical: Any, except acrobatics

Pilot: Any (+10%)  
Pilot Related: Any (+10%)  
Rogue: None  
Science: None  
Technical: Any (+10%)  
Weapon Proficiencies: Any  
Wilderness: Any

**Secondary Skills:** The character also gets to select six secondary skills from the previous list. These are additional areas of knowledge that do not get the advantage of the bonus listed in the parentheses. All secondary skills start at the base skill level. Also, skills are limited (any, only, none) as previously indicated in the list.

**Standard Equipment:** Kuru or "Trooper" body armor, energy rifle and energy sidearm of choice, four extra E-clips for each, four grenades, two signal flares, survival knife, utility belt, dress uniform, field uniform (includes combat boots), survival kit (canteen, gas mask, radio, 1 week's worth of rations, fishing line and hooks, and first-aid kit), and two non-energy weapons of choice. Glitter Boy vehicles are provided for field use only. Other bots, armor or weapons may be provided for special assignments.

**Money:** Room and board are provided by the military at no cost, plus the soldier has a starting salary of 3000 credits a month. Starts out with one month's pay.

**Cybernetics:** 1D4 to start; additional cyberware is usually restricted to medical implants.

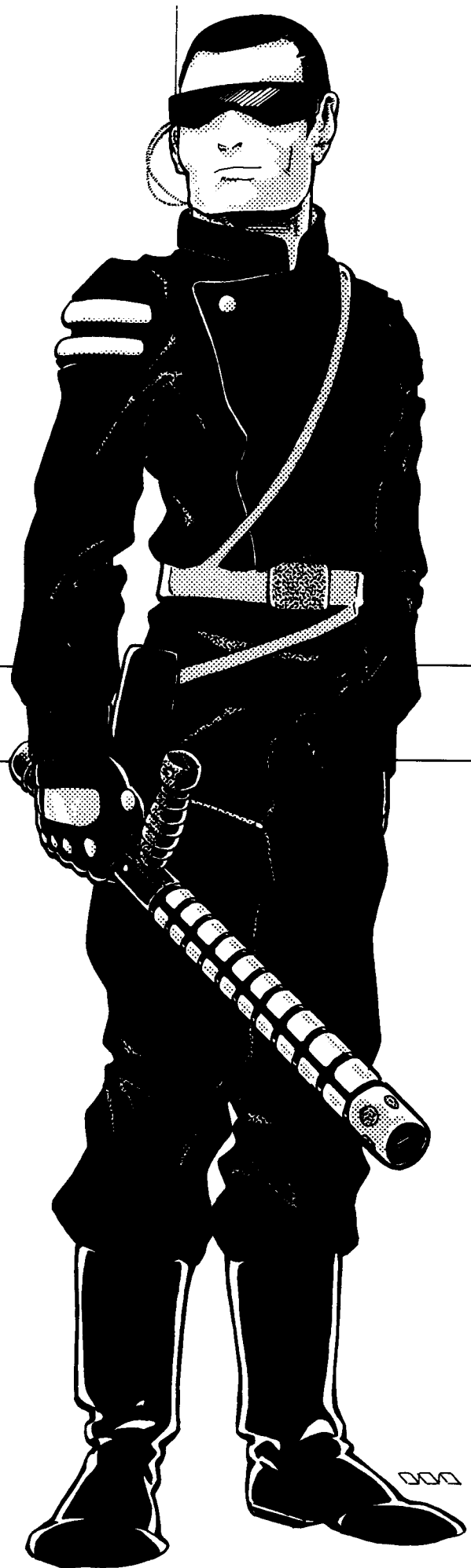

---

## Police Officer O.C.C.

---

The policemen (and women) of the New Republic have many problems and situations to contend with. In addition to the inevitable crimes that are the province of all large cities (even in the traditionally law-abiding Japanese islands), post-Rifts cops have to deal with gangs of cyberoid street-rats, corporate ninja, tech-ninja, juicers, smugglers, drug dealers, criminals, supernatural predators hiding between skyscrapers or under the sewers, the possibility of demon-led raids and invasions, and riots and protests sponsored by anti-techies, pro-techies, anti-D-bees, D-bee rights activists, and countless other troublemakers. At the same time, they must be civil and courteous, and unlike the military, they have less free access to the use of lethal force.

Despite all these difficulties, the police department does a good job. Its officers have paramilitary training, enabling them to assist the Republican Army in case of emergencies. Additionally, they have a good grasp of computer technology, cybernetics and technology. They have a number of cybernetic implants, many of which serve in enhancing their crime-fighting skills. Their training allows them to recognize the more common types of monsters and demons plaguing Japan, and the methods used to combat them.

Most police officers are honest and dedicated individuals. However, many feel beholden to the powerful corporations that influence the New Republic. As a result, most police officers are reluctant to investigate crimes and charges that might implicate a corporation, unless overwhelming evidence points their way. If the latter is the case, however, most (80%) of all police officers will do their duty, regardless of the consequences. Of the rest, some 10% are in the corporations' pockets! Some are even deliberate infiltrators, ninja or spies "planted" by the corporations; these agents will inform the corporation and try to cover up any evidence of their sponsor's involvement. The other 10% may feel duty bound to warn the corporation under investigation to give its executives a chance to either clear themselves or give themselves up honorably. Additionally, some 15% of the cops will accept bribes to look the other way for *petty* or relatively harmless crimes, including the

possession of illegal cybernetics, but 95% will not be bribed or intimidated away from serious crimes like murder, rape or kidnapping.

**Attribute Requirements:** I.Q. and P.S. 10 or higher.

**O.C.C. Skills:**

- Basic Mathematics (+10%)
- Language: Japanese & American (+20%)
- Literacy: Japanese & American (+20%)
- Computer Operation (+10%)
- Radio: Basic (+10%)
- Surveillance Systems (+10%)
- Streetwise (+10%)
- Find Contraband, Weapons, & Cybernetics (+10%)
- Criminal Sciences and Forensics (+3%; if taken twice (as an "other" skill), raise this to +10%)
- Demon and Monster Lore (+5%)
- Running
- W.P. Energy Rifle
- W.P. Blunt (nightsticks and stun clubs)
- Hand to Hand: Aikido
- Hand to hand: aikido can be changed to **jujitsu** or karate at the cost of one "other" skill.

**O.C.C. Related Skills:** Select six other skills. Plus select one additional skill at levels three, six, nine and twelve. All new skills start at level one proficiency.

- Communications: Any (+10%)
- Domestic: Any
- Electrical: Basic Electronics only
- Espionage: Disguise, Escape, Intelligence and Sniper only (+5%)
- Mechanical: Automotive and Locksmith only
- Medical: First Aid only (+10%)
- Military: None (unless a member of the "Bomb Squad;" +10%)
- Physical: Any, except acrobatics
- Pilot: Any (+10%)
- Pilot Related: Any (+5%)
- Rogue: Any
- Science: Any
- Technical: Any (+10%)
- Weapon Proficiencies: Any
- Wilderness: Any

**Secondary Skills:** The character also gets to select three secondary skills from the previous list at level one, four and ten. These are additional areas of knowledge that do not get the advantage of the bonus listed in the parentheses. All secondary skills start at the base skill level. Also, skills are limited (any, only, none) as previously indicated in the list.

**Standard Equipment:** AT-N20 neural stick, AT-20 "Sharpshooter" pistol, AT-23 stun rifle and/or AT-88 combat rifle (for emergencies), light body armor (typically **Kuru** or "Trooper" armor), police radio, and issued a police cruiser (Lightly armored: M.D.C. 120, tire M.D.C. 15, has car radio). Jet packs, power armor and other special equipment may be issued under the right circumstances.

**Money:** Have a salary of 2600 credits a month (does not get free room and board); starts with one month's salary in cash.

**Cybernetics:** At first level, the police officer starts with 1D4+2 implants of choice. Additional implants must be purchased at the character's own expense.

**Note:** 10% of the police force are full conversion borgs and another 12% are partially reconstructed borgs — see the section on the Cyborg O.C.C. for general data about 'borgs. 22% of the force is composed of SAMAS pilots (see O.C.C. in this section).

## O.C.C.s from the Rifts® RPG & World Books

Except for a few exceptions, most of the O.C.C.s and R.C.C.s found in the *Rifts® RPG* and *Rifts® Mercenaries* are also appropriate for Republic of Japan and the Japanese Islands in general. Only the Coalition States characters, Dog Boys, **techno-wizards** and the **Naruni** have absolutely NO presence in Japan or Asia. Of course, since most of these characters will be indigenous to Japan and the Orient, their attitudes will reflect their environment, and the weapons and equipment will have to be adjusted to this part of the world. Remember, Japan rarely gets any visitors from the west.

There are also a number of O.C.C.s and R.C.C.s presented in other *Rifts® World Books* which have appeared in Japan, but most will be a *rarity*, with the exception of **Horune** pirates from *Rifts® Underseas*. The notable O.C.C.s and R.C.C.s in Japan include:

Any character from **Rifts® Underseas**

**Chiang-Ku** — **Rifts® England**

Herbalist — **Rifts® England**

Hindu Gods — **Rifts® Conversion Book 2: Pantheons of the Megaverse®**

**Kilin** — **Rifts® Conversion Book One**

Dragons: European style — **Rifts® Conversion Book One**

Monsters; various — **Rifts® Conversion Book One**

Temporal Raiders and Wizards — **Rifts® England**

True **Atlanteans** — **Rifts® Atlantis**

Minions of **Splugorth** — **Rifts® Atlantis**

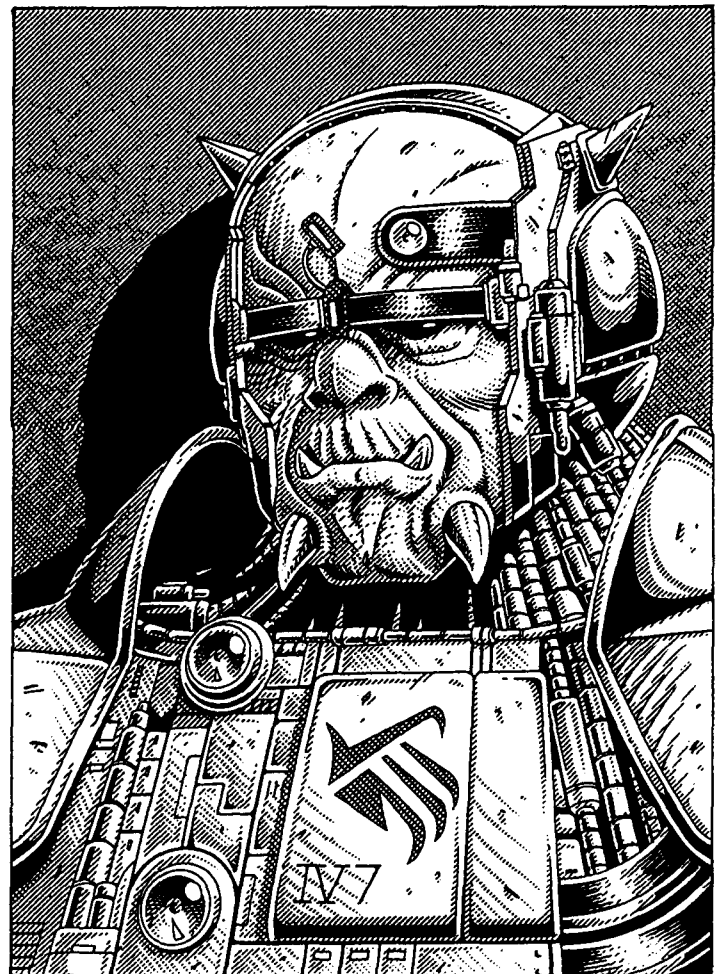

---

# Cyborgs of Japan

---

## Cybernetic & Bionic Augmentation

Bionics, heavy-duty cybernetic systems designed for war, are occasionally available to the public, but are generally limited to government personnel, police and powerful corporations. In fact, partial and full conversion borgs, are a common sight in the cities of the Republic of Japan. A full 20% of the Republic's population are cyborgs, and lingering evidence of pre-Rifts Japan's devotion to cybernetic augmentation (as well as robots and power armor). In the military, a large number of troops have undergone cybernetic or bionic alteration. Most troops will have various implants such as optics, amplified hearing, etc., which allow them to perform better in the field. Nearly 33% of all combat soldiers have undergone partial or full bionic augmentation due to injury or by personal choice.

Most cyborgs seen walking the city streets or patrolling the skies above, are active military or law enforcement personnel. Others are decommissioned borgs retired from these agencies, although many remain in the reserves and are citizens committed to public safety or civil defense. Bionic visitors are likely to be adventurers or mercenaries with proper authorization to visit from the Immigration Department.

Cybernetic implants and bionics are also available through the criminal underworld, often with tragic results. Petty crooks, gang members, hit men, industrial spies, **tech-ninja**, and enforcers turn to illegal body chop-shops to attain bionics to better assist them in their criminal pursuits. Body chop-shops also attract **Cyberoids** looking for something more powerful or deadly than legal cybernetics, corporate executives looking for protection or an advantage over the competition, meres and **cyber-samurai** looking for power, and others allured to the power or glamour of augmentation.

While most technocrats regard cyborgs as the perfect infantryman with capabilities equal to power armor, the Shinto traditionalists warn that bionic conversions can result in the loss of one's humanity. Perhaps because of the pervasiveness of human augmentation, there is a small, grass-roots movement, encouraged by the **anti-techies**, to move away from such extreme measures of augmentation and return to a more "natural" and "traditional" way of life (although not the complete abandonment of **technology** as the New Empire would like to see). Similar sentiments are held by those who practice magic and nurture psionic abilities.

## Japanese Bionic Conversion

Advanced bionic and cybernetic technology has enabled the Republic of Japan, **Ichto** and even **H-Brand** to produce powerful artificial limbs and body parts to replace flesh and bone. This bionic augmentation is very similar to those used in other parts of the world. The only genuine differences are the people's acceptance and comfort with bionics and cyborgs and the development of extremely light bionics using **nano-technology**. The advantage of the light systems is that they enable the bionic engineers to create very small **and/or**human-like **'borgs** without sacrificing the cyborg's strength, speed and other features.

The distinctions between *light* and *heavy* systems is that heavy bionics are reserved for the rigors of front-line combat and heavy support/defense, while light bionics are more general purpose and used for infiltration, security and police work. Heavy bionics are large, bulky and definitely not human. Additionally, the heavy 'borg can be covered in heavy plate armor and bristling with weapon systems, while the smaller, lighter frame **can't** accommodate heavy, giant-sized weapons and can't even have large or obtrusive forearm weapons if they are in-

tended for espionage and infiltration. Also, light **'borgs** can be disguised to look completely human and can wear any human-sized clothing, body armor, and equipment.

## Partial Bionic Reconstruction

The partial conversion limits the maximum attribute levels of the bionic limbs because of the limits of the human body — it can not endure the strain.

The first number indicates the most common attribute level generally provided to *light* **'borgs** active in the civilian population, including police, detectives, and security teams. The second number is the absolute maximum possible from a partial reconstruction and typically reserved for military cyborgs'.

### Light Partial Bionics

**Typical 'borg with partial light bionic reconstruction:**

P.S. 18/max 20, P.P. 18/max 20, Spd. 44 (30 mph/48 kmph)/maximum speed is 50 (35 mph/56 kmph).

**Penalties of light partial conversion:** Simulated sense of touch, while a remarkable 76%, is less than a human. No prowl penalty, unless wearing body armor. Average weight combined with the average body is 250 to 300 pounds (113 to 136 kg), while the height remains unchanged.

### Heavy Partial Bionics

**Typical military soldier with partial heavy bionic reconstruction:** P.S. 20/max 22, P.P. 18/max 20, Spd 50 (35 mph/56 km)/maximum speed is 68 (45 mph/72 kmph).

**Penalties of heavy partial conversion:** Simulated sense of touch is a mere 52%. Prowl is difficult: -10%. Average weight combined with the average body is 550 to 600 pounds (249 to 272 kg) and add 1D6 inches (2 to 15 cm) to original height.

---

## Full Bionic Conversion

The first number indicates the standard attribute level provided to most **'borgs**. The second number indicates the absolute maximum level of performance possible, usually reserved for Special Forces and other elite operatives.

### Light Full Bionics

**Typical cyborg with full light bionic reconstruction:**

P.S. 20/max 24, P.P. 20/max 22, 132 (90 mph/144 kmph)/maximum Spd 176 (120 mph/192 kmph). M.D.C. without additional body armor: 110.

**Penalties of light full conversion:** Simulated sense of touch is a mere 56%. Prowl is difficult and suffers a penalty of -15%, or -30% in heavy armor. Average weight is 450 to 600 pounds (204 to 272 kg). Average height is 6 to 6 1/2 feet (1.8 to 1.95 m).

### Heavy Full Bionics

**Typical military cyborg with full heavy bionic reconstruction:**

P.S. 24/max 30, P.P. 24/max 26, Spd 132 (90 mph/144 kmph)/maximum speed is 176 (120 mph/192 kmph). M.D.C. without additional body armor: 180.



**Penalties of heavy military full conversion:** Simulated sense of touch is a mere 44%. Prowl is very difficult and suffers a penalty of -40%; impossible in heavy armor. This process increases the size, mass and shape of the individual, making him a metal behemoth towering above normal humans. Average height is seven to nine feet (2.1 to 2.6 m). Average weight is 1000+ pounds (450 kg).

**Note:** Also see the *dragon 'borg* descriptions.

## Cyborg Body Armor

These are additional body plates and armor protection that are attached to the cyborg for combat. In the case of the dragon 'borg, the additional armor is built into the body.

Light Undercover (Police) — 50 M.D.C.

Light Infiltration (Police and Military) — 110

Light Infantry (Military) — 150

Heavy Infantry (Military) — 240

**Note:** *Ichto* and *H-Brand* both offer *infantry* armor with 20% more M.D.C.

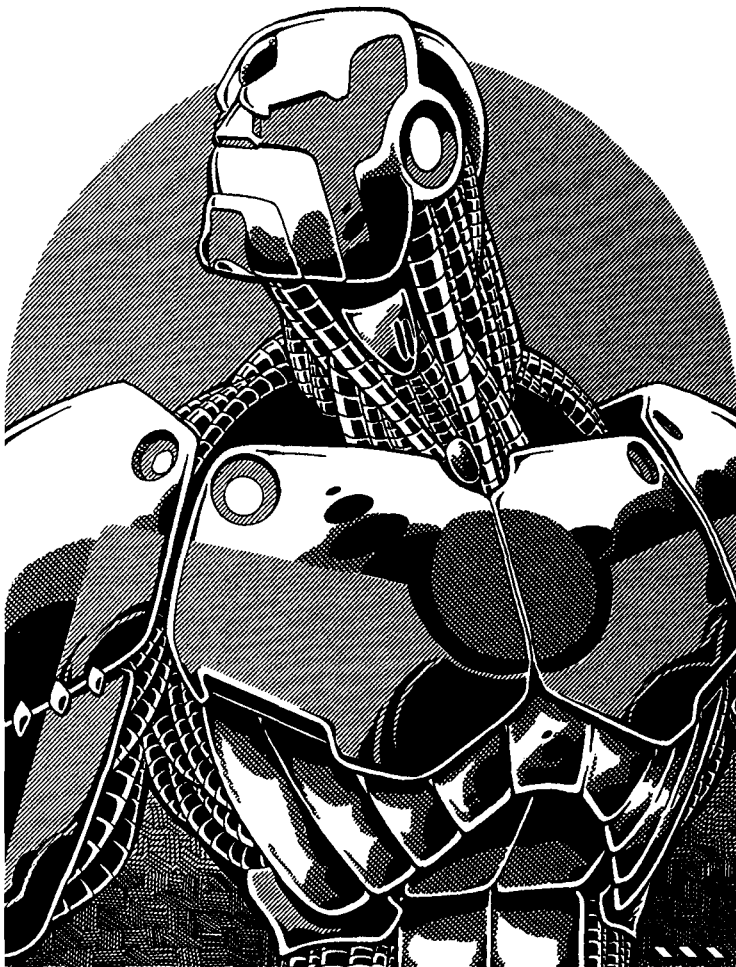

## Republic Cyborg Soldier O.C.C.

In the Republic of Japan, cyborgs are regarded as mechanized super-warriors held in the highest esteem. Although power armor and robots frequently offer greater armor protection and heavier weapons, thousands volunteer to become cyborg soldiers for the military and law enforcement agencies. There are some advantages to being a cyborg rather than using power armor or bots. For one, there is no feeling of claustrophobia — being stuck in a "tin can" for 24 hours or longer, or a need to get out and stretch one's legs. Nor does the 'borg need to worry about

getting caught without or outside his armor; a cyborg is a mega-damage war machine 24 hours a day. The bionic conversion feels natural and responds at the speed of thought as if it were a natural, living part of the body. Furthermore, in Japanese society, there is no stigma to being a 'borg. In fact, most 'borgs are regarded as heroes and little children which run up to cheer them and sit in their laps rather than run away in fear, dramatically reduces the psychological stress and strain of being both less and more than human. Cyborgs are so accepted in the pre-Rifts cities, that many kids grow up anxious for the day they "can become a 'borg to serve our people."

Even in this positive atmosphere, all candidates for full bionic conversion are carefully screened and undergo elaborate psychological testing and analysis — the government tries to turn as few unstable sociopaths and psychotics into super warriors as possible. All candidates for such conversion are thoroughly evaluated and prepared for life as a living machine. And they've done an excellent job too, less than 2% wash out because of mental trauma or psychosis. A full 20% of the Republic's Armed Forces are full conversion 'borgs, 13% are partial reconstructed borgs, and 60% of the soldiers have minor cybernetic implants and/or cybernetic prosthetics.

A cyborg soldier must be either a partial or full conversion cyborg. Although there are special operatives, variants and exceptions (use the 'borg design rules in the *Rifts RPG*), the Republic of Japan has several specific cyborg designs used by the military and law enforcement agencies, including the dragon 'borgs. **Note:** *Ichto* can also produce any of the cyborgs available from the Republic, including dragon 'borgs. Its conversion of mercenaries and adventurers without the full psychological screening and training process is yet another area of contention between these two.

**Attribute Requirements:** M.E. 15 or higher, a good I.Q. and M.E. are desirable but not necessary. Any human with the spirit to fight and in good mental health can become a cyborg soldier.

**O.C.C. Skills: Soldier** — Police get the skills listed under the Police O.C.C. rather than soldier; likewise, mercenaries get the skills appropriate for their line of work (see *Rifts Mercenaries* for a selection of these freelance warriors for hire).

Math: Basic (+10%)

Literacy: Japanese at 98%

Language: Japanese 98%, plus one language of choice (+15%)

Radio: Basic (+10%)

Computer Operation (+10%)

Pilot skill of choice (+20%)

Pilot Jet Pack (+20%)

Demon & Monster Lore (+10%)

Find Contraband, Weapons & Cybernetics (+10%)

Land Navigation (+10%)

Climbing (+10%)

Swimming (+10%)

W.P. Energy Rifle

W.P. Heavy Energy Weapons

W.P. **One** of choice.

Hand to Hand: Basic Martial Arts/Judo

Hand to hand: basic can be changed to aikido or karate at the cost of one "other" skill, or to jujitsu at the cost of two "other" skill selections.

**O.C.C. Related Skills:** Select five "other" skills, plus select one additional skill at levels four, eight, and twelve. All new skills start at level one proficiency.

Communications: Any (+10%)

Domestic: Any

Electrical: None

Espionage: Intelligence and detect concealment only.

Mechanical: Basic mechanics only.

Medical: First aid only (+10%)  
Military: Any (+10%)  
Physical: Any that are still appropriate.  
Pilot: Any (+10%)  
Pilot Related: Any (+10%)  
Rogue: Any (+5%)  
Science: None  
Technical: Any (+10%)  
W.P.: Any  
Wilderness: Any (+5%)

**Secondary Skills:** The character also gets to select two secondary skills from the list, excluding those marked "None," at levels two, five, eight and thirteen. These are additional areas of knowledge that do not get the advantage of the bonus listed in parentheses. All secondary skills start at the base skill level.

**Standard Military issue for Cyborg Soldiers:** All the appropriate ammunition and equipment for the 'borg's body styling and weapon systems. Energy rifle of choice, four extra **E-clips**, four grenades (excluding armor dissolvers, unless provided for special assignment), distancing binoculars, utility belt, backpack, walkie-talkie (for back-up) and regular maintenance and repairs.

**Equipment Available Upon Assignment:** Jet pack, hover vehicle or transportation, additional weapons, and equipment. The character also has access to most military bases (medium security clearance), hospitals and facilities. **Note:** Availability of equipment and resources may be dependent upon the local commander, supply stock, location, casualties and combat conditions.

**Money:** The soldier gets a roof over his head, food, clothing, medical care and all other basic needs provided free as part of his/her pay. The character also receives a monthly salary of 2000 credits (the savings of a first level character is **1D6x1000** credits). High ranking officers (9th level and higher) get 3500 to 5000 credits a month. Police 'borgs get 800 credits more a month than the average non-augmented officer.

Soldiers' quarters is a nice, dormitory style barracks. Four soldiers share one dormitory area. Each gets a private bedroom and study with a personal computer, computer games, stereo, and television. All share one bathroom, a sitting room, and living room area. Or the soldier can opt to live off base at his own expense.

**Rank:** Standard military; private to general.

**Bionic Conversion:** Any of the cyborgs described in the cybernetics and borg section of this book are available as player characters.

---

## Decommissioned Cyborgs

---

When a 'borg leaves military or police service he or she has a few different options:

**1. Keep basic bionics and remain a citizen:** All external weapons such as rail guns, **vibro-blades** and forearm blasters are removed. Likewise, spy systems like **cyber-disguises** will be removed, although cameras and enhanced hearing are usually left untouched. The character must then register with the *Cyborg Civilian Commission* which helps the character adjust to civilian life, find employment and keeps tabs on his conduct. As long as the cyborg does not abuse his superhuman abilities, doesn't break the law and functions well within society, he can live out his life in peace. Many belong to the Military Reserves or get work as police officers, private detectives, bodyguards, bouncers, and in construction.

**2. Special Consideration for Service:** Military and police cyborgs with long (25-60 years of service) or distinguished careers (a hero) may

be allowed to keep the majority of their bionic systems, including light or medium body armor and basic bionic weapons, like vibro-blades and forearm weapons. This is only possible if the government has approved and authorized the character's moving into the private sector as a security operative (corporate or private business) or to a police agency, or if the cyborg is moving out of the city to pursue a career as an adventurer or mercenary. In the latter case, the character relinquishes his citizenship and although he can visit the Republic of Japan as an *authorized* foreign visitor (if approved by the immigration department), he or she cannot live within the borders of the nation.

**3. Retro-conversion:** "Retro-conversion" or "retro-fitting" of cyborgs means the majority of their bionic **components/body** are replaced with flesh and blood bio-systems! Partial reconstruction borgs have their bionic limbs and special bionic implants, like lungs, molecular analyzers, weapons and the likes, replaced with lifelike bio-systems. The bio-system limbs are genetically encoded from the character's own DNA to prevent rejection and to be as lifelike as possible.

Full conversion borgs can undergo a similar process in which the vast majority of their bionic systems are replaced with bio-systems, but the basic body (spine, chest, skull, skeleton and internal organs) are likely to remain artificial, bionic constructs. The big difference is that a certain portion has been replaced with bio-systems and what bionics remain are downgraded to a basic level to be as close to human as possible. This process is painful and very expensive. (Note: P.S., P.P, and Spd attributes are 18 for those who retire honorably, but 10 for criminals or those dishonorably discharged from service. In some cases, those scheduled for a dishonorable discharge go AWOL, fleeing to other kingdoms or becoming mercenaries outside the Republic).

Frequently, the preferred alternative is to receive a clone body! The body is "fast grown" in a genetics laboratory from the cyborg's original DNA (takes three years) or a fully grown "genetic blank" clone body with altered DNA can be used (takes three months).

The use of a cloned body has been under moral, ethical and political fire from the day it was conceived. Those opposed to such a practice insist that the clone is a separate, living being and that not allowing it to grow as a person is inhumane, and removing its brain in order to replace it with the 'borg's is murder! The debate continues, but in this new world, with the slow movement to at least some increased spiritualism and tradition, it is likely that this practice will be discontinued within the next 20 years.

**Note:** Retro-fitting is also performed on 'borg criminals and dissidents.

---

## Life Expectancy

---

**Bio-system retro-fitting:** 50+2D4 years from the date of being refitted. Including the person's early years of development and his years as a cyborg, this should provide the character with the approximate equivalent life expectancy of the *average human* living in the Republic of Japan, which is 140 years; with modern medicine, genetic manipulation, and artificial bio-systems, some people may live healthy, productive lives to 200!

**Clone body:** 90+3D6 years from the date of being placed in a clone body of a "fast grown" clone keyed to the character's exact genetic make-up, or 50+4D6 years for a "genetic blank" which tend to deteriorate more quickly and reject genetic correction.

**Partially reconstructed 'borg:** Roughly equal to the normal Republic human, 140 to 180 years.

**Full conversion 'borgs:** With regular maintenance and replacement of old or defective parts, and avoiding brain damage, trauma or mental deterioration, the borg could remain active for 300+ years.

**Note:** Also see the various Cyborg O.C.C.s and the bionic section for more data about bionics and implants.

---

## Laws Governing Cybernetic Systems

---

**Note:** In the Republic of Japan, most of the laws regarding the use of implants and bionics are harsh and strictly upheld to keep these augmented supermen in line and to protect the common people.

In most instances, the penalty for having illegal cybernetic or bionic systems which have *not* been used in the commission of a crime, is their removal, having to reimburse the state for the cost of removal, plus 10% (can range from a few hundred credits to 10,000), acquiring a permanent criminal record for the use of illegal cybernetics, and probation.

**Repeat offenders** and perpetrators of particularly heinous crimes are often legally *prohibited* from ever getting cybernetics/bionics for the rest of their lives. Breaking such a prohibition is punishable by life imprisonment (40-60 years) and even the death penalty.

**The Death Penalty** is reserved for murderers, mass murderers (an easy distinction in this world of mega-damage weaponry and bionics), traitors and the perpetrators of heinous crimes that endangered the lives of citizens or the security of the nation.

### Some Common Laws, Cyber-Crimes & Penalties:

- **"Custom" alteration of legal cybernetic systems** may be considered illegal and subject to removal. In 67% of these cases, the person is charged with a misdemeanor and does not get a criminal record unless a repeat offender (8 or more "customizing" charges). The courts tend to be lenient in this area because **Cyberoids** tend to be precocious, daring and foolish and aren't involved in criminal activity, they're just techno-junkies.
- **Concealed weapons without a permit** are illegal and subject to removal. Those in violation will have the weapon removed immediately, be fined the cost of the removal operation (+10%) and placed on probation.
- **Bionic systems without authorization** by the government are illegal and subject to immediate removal and possible criminal charges; same as above. Note that it is not illegal to get bionics installed out of the country, but it is illegal to bring them back in.
- **Breaking a court ordered cybernetics/bionics prohibition:** A serious offense that will result in the removal of all cybernetic systems, the usual fee plus 30%, and 1D4 year prison term. Repeat offenders may see jail terms of 10-20 years.
- **Using illegal cybernetic weapons, disguises, or bionic systems in the commission of a crime** adds a three to 10 year penalty and a 10,000 credit fine to the usual penalties for the particular crime. This is in addition to the removal of the illegal systems. Repeat offenders may be subject to a complete retro-fitting/removal of all artificial enhancements, lifetime imprisonment or even execution!
- **Reckless use of cybernetics/bionics and endangerment (includes vandalism and accidental discharge of weapons):** 500-1000 credit fine. Repeat offenders may be placed on probation or even see the court order to have the offending cybernetic feature removed.
- **Assault with an authorized cybernetic or bionic implant (includes brawls and duels):** 1000-10,000 credit fine, plus restitution for any damage inflicted as a result of the assault. Repeat offenders or particularly violent or unprovoked attacks may land the perpetrator in jail (2D6 months) and/or see the court order to have the offending cybernetic feature removed immediately.
- **Assault with intent to commit great bodily harm/murder with an authorized cybernetic or bionic system — or manslaughter:** Premeditated assault will result in the immediate court ordered removal of all bionics, potentially lethal cybernetic implants and 1D4 years in

jail. **Note:** Unauthorized bionics or illegal cybernetics will be removed and the prison time **doubled!**

- **Unpremeditated assault with intent to commit great bodily harm:** 1000-10,000 credit fine, plus restitution for any damage inflicted as a result of the assault. Repeat offenders or particularly violent or unprovoked attacks may land the perpetrator in jail for a year and/or see the court order to have the offending cybernetic feature and any other weapon systems removed immediately.
- **Premeditated Murder with bionic or cybernetic systems:** Life imprisonment (40-60 years) or execution.
- **Killing a person for cybernetic or bionic components** is punishable by life imprisonment (40-60 years) and the possibility of execution. Repeat offenders or mass murderers are automatically executed.
- **Removal of cybernetic implants or bionics against a person's will** is a heinous crime punishable by 20-40 years in prison without parole.
- **Operating a body chop-shop:** 20 years in prison. Repeat offenders (3 times) may be imprisoned for life (40-60 years).
- **Stealing, smuggling and/or selling or distributing stolen cybernetic systems** has a penalty of 5 five years in prison.
- **Stealing, smuggling and/or selling or distributing stolen bionic (military/war) systems** has a penalty of 20 years in prison and may be considered an act of treason.
- **Age restrictions for cybernetic augmentation:** No one under the age of 16 can receive cybernetic implants except for medical purposes.
- **Age restrictions for bionic reconstruction or conversion:** No one under the age of 20 can undergo bionic reconstruction or conversion.

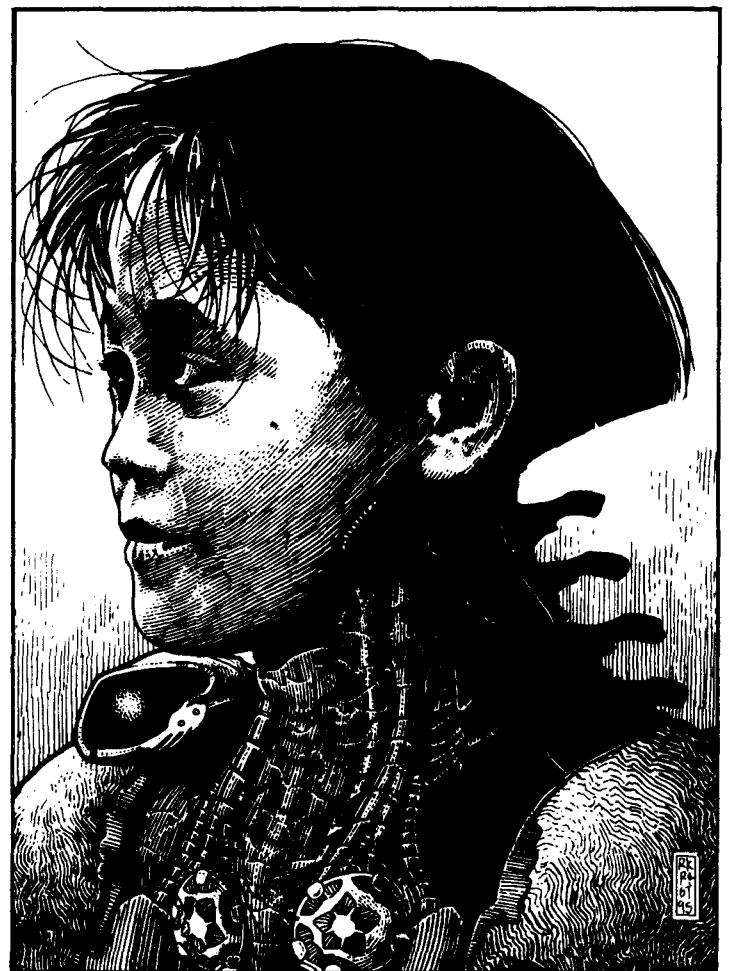

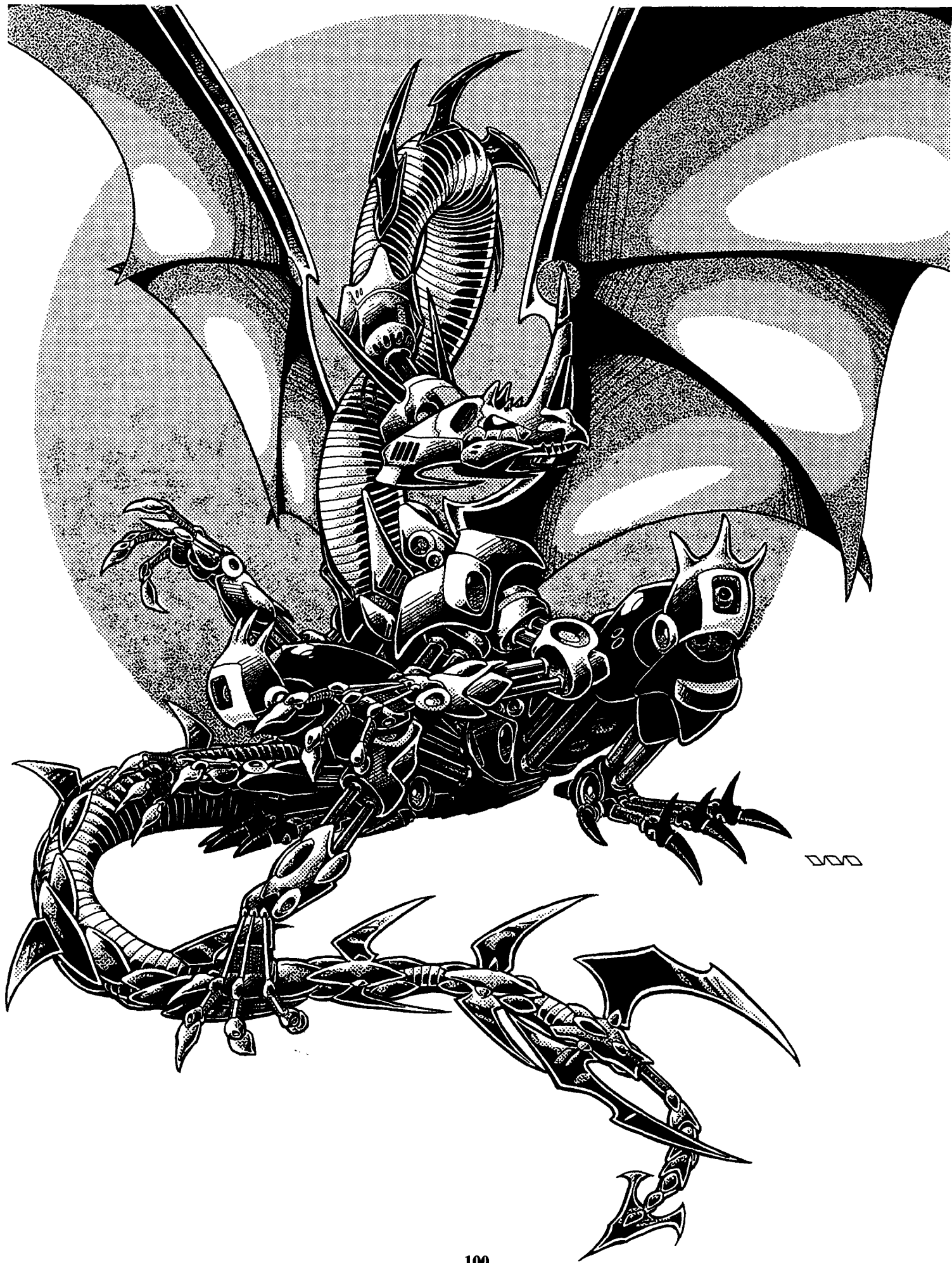

---

# Dragon 'Borgs

Cyborgs may be considered freaks or monsters in some parts of Japan, but to the **Cyberoids** of the Republic they are commonplace, respected, and often admired. It was an environment so comfortable with the idea of bionic augmentation that full conversion cyborgs like the *dragon 'borgs* were made possible.

Dragons have always been regarded as spiritual beings who represent strength, wisdom and magic. The dragon **'borgs** represent the same things in the minds of the characters who become them. The dragon **'borgs** were a logical step, considering the world the people of the Republic of Japan have been thrown into. Nobody remembers whose idea it was, but this inhuman cyborg styling has been astoundingly popular.

Note: Same O.C.C. skills as the cyborg soldier, unless a police officer or mercenary.

---

# Wing Blade 'Borg

The Wing Blade gets its name from the fact that it has its pair of bat-like mechanical wings and a long, prehensile tail lined with blades. However, its less dramatic nickname is the "Snoop." The name is appropriate because it is designed to function as a spy and engage in espionage and reconnaissance. The long, flexible neck enables the character to look over walls and peek around corners (the head up high or down at foot level) without having to show its body, as well as stick its head into small openings, through air ducts, and so on. The legs are made for leaping and a loping run, so the 'borg can get in and out of an area quickly, and dodge attacks. The prehensile tail can also snake around corners to snatch an item, feel around in small spaces and tunnels, or strike or entangle an opponent. Plus the **'borgs** is silent, equipped with cameras and sound recording equipment, has four arms, a slender body, and has (folding) wings so it can fly and still fit just about anywhere!

Note: The following stats are for the "standard" **AT-C8000** full conversion borg. Specific weapons and bionic features may change slightly from 'borg to 'borg.

Model Type: **AT-C8000**, Wing Blade; a.k.a. "Snoop" or "Snooper"

Class: Full Conversion Cyborg — Espionage & Light Assault

Crew: One human volunteer.

## M.D.C. by Location:

- \* Hands (2) — 15 each
- Arms (4) — 40 each
- Legs (2) — 110 each
- \* Tail (1) — 50 M.D.C. per 6 ft (1.2 m) length
- \* Cheek Blades (2) — 10 each
- Wings (2; folding) — 90 each
- Head — 90 (reinforced)
- Neck — 120 (reinforced)
- \* Neck Cameras (4; two on each side) — 2 each
- \* Knee Cameras (2; one each) — 2 each
- \* Nose **Horn/Grapple** (1) — 15
- \* Head Horns (2; back of head) — 10 each
- \* Removable Jet **Thruster** (1, back) — 80
- \* Tiny Maneuvering **Thrusters** (10; legs and back) — 5 each
- \*\* Main Body — 270 M.D.C.; cannot wear additional body armor (built in).

\* A single asterisk indicates a difficult target to strike and the attacker must make a called shot and even then he is -3 to strike. Destroying the head of a cyborg will kill the character! However, the head is a small and difficult target to hit.

\*\* Depleting the M.D.C. of the main body will effectively destroy the artificial body, but emergency systems will keep the brain and vital organs alive for 36 hours. Recovery of the severely damaged body will enable doctors to place the character on a life support system that will keep him alive until a new bionic body (same style or other) is available for full conversion. Failure to find the damaged **'borg** within 36 hours means the character dies. Similarly, massive amounts of damage (**125** points below zero) completely destroys the **'borg** with no hope for recovery.

Note: If one or both of the wings are destroyed, the **'borg** can still fly via the detachable jet pack, but his control is greatly reduced and is -20% on piloting skill.

## Speed

Running: **120 mph** (192 km).

Leaping: The powerful bionic legs are strong and capable of leaping 25 feet (7.6 m) high or lengthwise. A running leap at adds **1D4x10** additional yards/meters.

Flying: Via jet pack only.

## Statistical Data

Height: The bulk of the body stands only five feet (1.5 m) tall, and when the wings are folded and the neck and head are hung low, the snoop stands only 7 feet (2.1 m) tall (5 **feet/1.5 m** when crouched). Wings extended adds 12 feet (3.6 m).

Width: 2 1/2 feet (0.75 m) for the body itself, and 3 1/2 feet (1 m) when the wings are folded.

Length: The long, snaking neck adds an additional six feet (1.8 m) and the tail another 12 feet (3.6 m), for a total length of 23 feet

Weight: **1000 lbs** (450 kg)

Physical Attributes: Equal to a P.S. 24, P.P. 22, Spd 176.

Power System: Nuclear, average life is 20 years.

Market Cost: Six million credits with all standard features and weapons. Poor availability; outside of the Republic, only **Ichto** makes them, and at 10% more money. **Armatech** makes the dragon **'borgs** exclusively for military and police use in the Republic of Japan; they are not available to the public.

## Standard Bionic Features (non-weapon types)

Note: These features are all found in the bionic and cybernetic sections **of the Rifts RPG**.

1. Bionic lung with gas filter & oxygen storage cell
2. Built-in language translator
3. Built-in loudspeaker
4. Built-in radio receiver & transmitter
5. Climb cord (concealed)
6. Clock calendar
7. Concealed compartment in each leg
8. Gyro-compass
9. Modulating voice synthesizer
10. Multi-optic eyes
11. Psionic electromagnetic dampers
12. Universal **headjack** with amplified hearing and sound filtration.
13. Universal **handjack**.
14. Six video cameras, two on each side of the neck, and one in each leg.
15. Extra pairs of arms
16. Long prehensile neck for looking around corners and "snooping."
17. Prehensile tail (with **vibro-blades**).
18. Wings for gliding and better control when flying (+10% to jet pack piloting skill). A common ploy is to turn the jet pack off when near a target and silently *glide* into position or attempt a surprise attack.

## Weapon Systems

**1. Prehensile Tail (1):** The tail can be used to feel around narrow openings, grab small objects, slash at foes, parry, or entangle.

Primary Purpose: Anti-Personnel

Mega-Damage: The tail is lined with three pairs of **vibro-blades** each of which can be launched like mini-missiles. The two smaller ones inflict 2D6 M.D., while the large one does 3D6 M.D.; each can be directed by the 'borg via remote control, but is -1 to strike for each one that is in flight, and each strike by these flying units counts as one of the character's melee attacks/actions. Range is limited to line of sight, with a maximum of 500 feet (152 m). If the flying blades aren't destroyed (15 M.D.C. for small, 25 for large), they return and can be **reattached** to the tail.

The tail is also tipped with a wicked **vibro-blade** that cannot be launched but used to stab (1D6 M.D.) or to hold or hook onto things to help in climbing.

Tail strike (blunt) 6D6 S.D.C.; restrained attack does half damage.

Attacks Per Melee Round: Total hand to hand melee actions.

Range: Tail reach is 12 feet (3.6 m); flying blades: 500 feet (152 m).

**2. Concealed Mouth Particle Beam Gun (1):** The character points, opens its mouth and fires!

Primary Purpose: Anti-Armor & Anti-Cyborg

Mega-Damage: 1D4x10M.D. per blast.

Rate of Fire: Equal to the total number of hand to hand attacks.

Effective Range: 1200 feet (365 m)

Payload: 24 per hour, but is patched into power supply so it regenerates.

**3. Grappling Spike (nose horn):** The rhinoceros-like horn on the snout can be used to jab, stab and parry opponents or the tip may be fired with a cable attached to it for climbing, snagging vehicles or bots, and similar tactics. After its use, the spike can be pulled out and retracted back into the horn-housing or the line cut and the spike abandoned.

Primary Purpose: Climbing tool. Anti-Armor & Anti-Cyborg

Mega-Damage: 1D4M.D.

Rate of Fire: Equal to the total number of hand to hand attacks.

Effective Range: 200 feet (61 m)

Payload: One

**4. Cheek Blades:** Used for parrying and slashing with the head.

Mega-Damage: 1D6M.D.

**5. Four Arms:** The four identical arms provide combat advantages (see bonuses in stat section), and enables the character to perform delicate mechanical operations (like bomb disposal) and enables him to use any human-sized pistols, rifles, rail guns, tools and equipment.

**6. Concealed Weapon Compartments:** The standard snoop has two concealed compartments in each leg. One contains a vibro-blade dagger (or stun stick or laser rod), and a pair of **stun/flash**grenades; the other typically has two extra **E-clips** and an RMK medical kit (for use on others).

**7. Hand to Hand Combat:** Rather than use a weapon, the cyborg can engage in mega-damage hand to hand combat. Remember, although sheathed in M.D. body armor and weapons, the cyborg's physical strength is S.D.C. based, except for the occasional special attack such as power punch.

Attacks per Melee Round: Equal to the character's hand to hand combat skill selection and experience, +2 additional attacks per melee (includes tail, neck and arm bonuses).

Combat Bonuses: +2 on initiative, +2 to parry, +1 to dodge, +2 to pull punch, +1 to roll with **punch/fall/impact**, and +2 to save vs horror factor; plus P.P. 22 bonus of +4 to strike, parry and dodge.

### Damage:

Restrained Punch — 1D6+12 S.D.C.

Full Strength Punch — 3D6+12 S.D.C.

Power Punch — 1D4 M.D. (counts as 2 melee attacks)

Head Butt — 2D6 S.D.C.

Kick — 4D6+12 S.D.C.

Jump Kick/Leap Attack — 2D4 M.D. (counts as 2 melee attacks)

Judo Style Throw/Flip — 3D6 S.D.C.

Full Speed Ram/Body Block — 1D4 M.D. (counts as 2 melee attacks)

Also see vibro-blade tail mega-damage.

**8. Typical Training/Skills:** See the **Cyborg Soldier O.C.C.** for complete details. Those assigned to demolitions automatically get demolitions disposal and demolitions (both +10%) as extra skills.

---

## Tsunami 'Borg

---

The second largest dragon 'borg produced by the New Republic, the Tsunami is a combat model designed for military and police actions. The police departments in the largest cities keep a small detachment of these powerful cybernetic warriors to deal with Oni, supernatural threats and the occasional renegade or criminal 'borg. Even fully bionic humanoid 'borgs respect and even fear these devastating combat models. In the military, Tsunamis fight with the infantry or assist powered armor troopers in all kinds of combat missions, from search and destroy to scout to sabotage. Their draconic appearance sometimes frightens uneducated peasants and even some lesser demons and supernatural beings.

The Tsunami has a built-in jet pack that gives the 'borg limited flying capabilities. Tsunamis are meant to operate mainly on the ground; however, they are nowhere near as fast or **maneuverable** as flying power armor, let alone regular aircraft. They have a number of weapon systems, from an integral arm minigun to laser-beam eyes, a pair of mini-missiles on the back, and **vibro-claws** on the hands and feet.

A lot of Tsunami 'borgs suffer from the inhuman shape and their often violent duties. After one year of service, there is a 2% chance that the character will experience some mental trauma (roll on the Random Insanity Table). This chance increases by an additional 1% every year after the first. Among the delusions and fears these cyborgs undergo includes the belief that they are "real" dragons, or an intense hatred and fear of true dragons! On the Random Insanity Table, replace Neurosis with Delusion: Believes he is a dragon; will greet true dragons and dragon-like beings as "**brothers**;" attitudes toward humanity remain friendly. Then replace Fear of Animals with **Fear/Hatred** towards Dragons: Will attack unknown dragons on sight unless warned and convinced the dragon is not an enemy, and will remain distrustful and wary of all dragons and dragon-like creatures.

Most Tsunami 'borgs do not suffer such problems, however, and have proved themselves time and time again on the field of battle. Their heroism has been immortalized in a number of patriotic posters, movies and **manga**, including the long-lived animated serial "Demon-Hunter Tsunami," detailing the adventures of a heroic cyborg. Tsunami 'borgs who can describe true-life heroic actions may see their exploits immortalized in **anime**, and be paid a 3D6x1000 credit "consultant fee"!

**Model Type:** AT-C9000, Tsunami

**Class:** Full Conversion Cyborg — Heavy Assault

**Crew:** One human volunteer.

**M.D.C. by Location:**

\* Hands (2) — 17 each

Left Arm (1) — 50

Right Weapon Arm (1) — 60







Legs (2) — 120 each

\* Tail/Particle Beam Cannon (1) — 70

Wings (2; folding) — 100 each

Head/Neck — 100 (reinforced)

\* Jet Thruster/Mini-Missile Launcher (1, back) — 80

\* Tiny Maneuvering Thrusters (10; legs and back) — 5 each

\*\* Main Body — 320 M.D.C.; cannot wear additional body armor (built in).

\* A single asterisk indicates a difficult target to strike and the attacker must make a called shot and even then he is -3 to strike. Destroying the head of a cyborg will kill the character! However, the head is a small and difficult target to hit.

\*\* Depleting the M.D.C. of the main body will effectively destroy the artificial body, but emergency systems will keep the brain and vital organs alive for 36 hours. Recovery of the severely damaged body will enable doctors to place the character on a life support system that will keep him alive until a new bionic body (same style or other) is available for full conversion. Failure to find the damaged borg within 36 hours means the character dies. Similarly, massive amounts of damage (125 points below zero) completely destroys the borg with no hope for recovery.

Note: If one or both of the wings are destroyed, the 'borg can still fly via the detachable jet pack, but his control is greatly reduced and is -20% on piloting skill.

### Speed

Running: 120 mph (192 km).

Leaping: The powerful bionic legs are strong and capable of leaping 25 feet (7.6 m) high or lengthwise. A running leap adds 1D4×10 additional yards/meters.

Flying: Via jet pack only. 100 mph (160 kph) maximum speed. Range is limited to twelve hours at maximum speed before the jet pack needs to cool down; indefinite with rest stops and low speed (80 mph/108 kph or less).

### Statistical Data

**Height:** 10 feet (3 m) when standing up straight (head to toes); the 'borg usually has a stooped posture that reduces this to 7-8 feet (2.1 to 2.4 m).

**Width:** 2 1/2 feet (0.75 m) for the body itself, and 3 1/2 feet (1 m) when the wings are folded.

**Length:** The tail adds 6 feet (1.8 m), for a total length of 16 feet

**Weight:** 1200 lbs (540 kg)

**Physical Attributes:** Equal to a P.S. 26, P.P. 23, Spd 176.

**Power System:** Nuclear, average life is 20 years.

**Market Cost:** Eight million credits with all standard features and weapons. Poor availability; outside of the Republic only **Ichto** makes them, and at 10% more money. **Armatech** makes the dragon 'borgs exclusively for the military and police of the Republic of Japan; they are not available to the public.

---

## Standard Bionic Features (non-weapon types)

---

**Note:** These features are all found in the bionic and cybernetic sections of the *Rifts RPG*.

1. Bionic lung with gas filter & oxygen storage cell
2. Built-in language translator
3. Built-in loudspeaker
4. Built-in radio receiver & transmitter
5. Climb cord (concealed)
6. Clock calendar
7. Concealed compartment in each leg

8. Gyro-compass

9. Modulating voice synthesizer

10. Multi-optic eyes

11. Psionic electromagnetic dampers

12. Universal headjack with amplified hearing and sound filtration.

13. Universal handjack

14. Striking tail (with built-in particle beam gun)

15. Wings for gliding and better control when flying (+10% to jet pack piloting skill).

16. Sensor System (equal to Sensor Hand), built into head.

## Weapon Systems

**1. Striking Tail/Particle Beam Gun:** The tail is not flexible enough to grab things, but can be used as a striking weapon. The tip has a **vibro-blade** to increase damage. Also, a particle beam weapon is built on the tail's tip.

Primary Purpose: Anti-Personnel, Assault.

Mega-Damage: Tail strike (blunt) 6D6 S.D.C.; restrained attacks do half damage. With the **vibro-blade**, the strike inflicts 2D4 M.D. Particle Beam: 5D6 M.D.

Attacks Per Melee Round: Total hand to hand melee actions.

Range: Tail reach is 6 feet (3.6 m); Particle Beam Weapon: 1,000 feet (305 m).

Payload: Effectively Unlimited.

**2. Arm Mini-Gun/Vibro-Axe:** Instead of a hand, the right arm contains are high-capacity mini-gun firing explosive bullets at very high cyclic rates. The rest of the arm is an ammo canister which feeds the mini-gun. Below the gun is a vibro-axe used in close combat.

Primary Purpose: Anti-Armor & Anti-Cyborg

Mega-Damage: Mini-Gun: A burst is 20 rounds and inflicts 1D4×10 M.D. Can only fire bursts. The vibro-axe inflicts 4D6 M.D.

Rate of Fire: Equal to the total number of hand to hand attacks.

Effective Range: 2000 feet/610 m (mini-gun); hand to hand (vibro-axe)

Payload: Mini-Gun: 1000 rounds in canister; that's fifty bursts.

**3. Mini-Missiles (2):** Mounted on the back, on top of the jet thruster system, are two mini-missiles used to engage enemy aircraft and monsters.

Primary Purpose: Anti-aircraft, Anti-armor.

Secondary Purpose: Defense.

Mega-Damage: Varies with missile type.

Rate of Fire: One at a time, or in volleys of two.

Effective Range: About one mile.

Payload: Two mini-missiles.

**4. Laser Eyes:** Mounted alongside the multi-optic system are two powerful but short-ranged laser **beamers**. The double-beam blasts always fire simultaneously unless the head has taken more than 20 M.D.C. points of damage, which will disable one of the two eye lasers. 40 M.D.C. points or more of damage will disable both lasers.

Primary Purpose: Anti-cyborg.

Secondary Purpose: Defense.

Mega-Damage: Single beam does 2D6 M.D.; simultaneous double beam blast inflicts 4D6 M.D.

Rate of Fire: Equal to the total number of hand to hand attacks.

Effective Range: 1000 feet (305 m).

Payload: Effectively unlimited.

**5. Concealed Weapon Compartments:** The standard Tsunami has two concealed compartments in each leg. One contains a vibro-blade dagger (or stun stick or laser rod), and a pair of **stun/flash** grenades; the other typically contains two extra **E-clips** and an RMK medical kit (for use on others).

**6. Hand to Hand Combat:** Rather than use a weapon, the cyborg can engage in mega-damage hand to hand combat. Remember, although sheathed in M.D. body armor and weapons, the cyborg's physical strength is S.D.C. based except for the occasional special attack such as power punch.

Attacks per Melee Round: Equal to the character's hand to hand combat skill selection and experience, +1 additional attack per melee (includes tail bonuses).

Combat Bonuses: +2 on initiative, +2 to parry, +1 to dodge, +2 to pull punch, +1 to roll with **punch/fall/impact**, and +2 to save vs horror factor; plus P.P. 23 bonus of +4 to strike, parry and dodge.

Damage:

Restrained Punch — 1D6+13 S.D.C.

Full Strength Punch — 3D6+13 S.D.C.

Power Punch — 1D4 M.D. (counts as 2 melee attacks)

Head Butt — 2D6 S.D.C.

Kick — 4D6+13 S.D.C.

Jump Kick/Leap Attack — 2D4 M.D. (counts as 2 melee attacks)

Judo Style Throw/Flip — 3D6 S.D.C.

Full Speed Ram/Body Block — 1D4M.D. (counts as 2 melee attacks)

Also see **vibro-blade** tail Mega-damage.

**7. Typical Training/Skills:** See the Cyborg Soldier O.C.C. for complete details. Those assigned to demolitions automatically get demolitions disposal and demolitions (both +10%) as extra skills.

---

## “Imperial” Combat ‘Borg

---

The AT-C10000, better known as the Imperial Dragon or merely the "Imperial," and its more advanced version, the AT-C12000 (see the Flame Cloud, below), are highly unusual 'borgs. Unlike most common models, their cybernetic frames are not even vaguely humanoid; the 'borg can run on all four legs, and the general stance and center of gravity is akin to a quadruped creature or a snake-like being — in short, a "true" dragon in form and design. The Imperial Dragon is little less than a tank in terms of armament, and is designed solely for combat. Most Imperials are serving in the Army of the New Republic, fighting monsters, bandits and demons.

The cyborg's twisting, serpentine body and low height (while on all fours) makes it an ideal guerrilla and anti-guerrilla warfare fighters; they can maneuver over all types of terrains, including slopes too steep for two-legged creatures to climb, and its low profile makes it harder to target with **counterfire**. Its main weapon is a triple particle beam cannon, supported by six mini-missiles, a smoke/gas dispenser and several lasers. In close-combat, a vibro-blade tipped tail and claws make it a lethal opponent, fully able to engage robots and power armor troopers.

All this power has some major drawbacks, however. The inhuman shape of the cyborg body can induce a number of psychological problems. Volunteers undergo several weeks of hypnosis therapy to condition them to the alien experience of being a metallic, inhuman beast, but even with it, a high number of people have become unbalanced after several years in this 'borg. Many cybernetic warriors manage to hide their insanities and carry on the fight; some estimates claim that as many as 30% of all Imperial Cyborgs are insane or at least unstable! The more conservative government reports claim that a mere 10% have some minor psychological problems, easily treated and cured. Use the rolls described under the Tsunami 'borg, but raise the chance to 5% on the first year, +2% per additional year.

**Model Type:** AT-C 10000, Imperial Dragon, a.k.a. Imperial or Imperial 'Borg.

**Class:** Full Conversion Cyborg — Heavy Assault

**Crew:** One human volunteer.

**M.D.C. by Location:**

\* Hands/Feet (2) — 20 each

Forelegs/Arms (2) — 50 each

Hind Legs (2) — 60 each

\* Prehensile Tail(1) — 50 M.D.C. per 6 ft (1.8 m) length.

\* Double Laser Turrets (2, on rear sides) — 80 each

\* Mini-Missile Launchers (2, on sides) — 100 each

Triple-Barrelled Particle Beam Gun (1) — 100

Smoke Dispenser (1) — 20

\* Head — 100 (reinforced)

\*\* Main Body — 350 M.D.C.; cannot wear additional body armor (built in).

\* A single asterisk indicates a difficult target to strike and the attacker must make a called shot and even then he is -3 to strike. Destroying the head of a cyborg will kill the character! However, the head is a small and difficult target to hit.

\*\* Depleting the M.D.C. of the main body will effectively destroy the artificial body, but emergency systems will keep the brain and vital organs alive for 36 hours. Recovery of the severely damaged body will enable doctors to place the character on a life support system that will keep him alive until a new bionic body (same style or other) is available for full conversion. Failure to find the damaged borg within 36 hours means the character dies. Similarly, massive amounts of damage (125 points below zero) completely destroys the borg with no hope for recovery.

**Speed**

Running: 120 mph (192 km) on four legs; drops to 20 mph (32 kph) on two legs.

Leaping: The powerful snake body can spring forward, capable of leaping 30 feet (9 m) high or lengthwise. A running leap adds 1D4×10 additional yards/meters.

Flying: Not possible.

**Statistical Data**

**Height:** 5 feet (1.5 m) while on all fours. If rearing up on its hind legs, the cyborg can stand 9 feet (2.7 m) tall.

**Width:** 2 1/2 feet (0.75 m) for the body itself.

**Length:** 24 feet (7.2 m) from head to tail.

**Weight:** 1500lbs (675 kg)

**Physical Attributes:** Equal to a P.S. 30, P.P. 22, Spd 176.

**Power System:** Nuclear, average life is 20 years.

**Market Cost:** Ten million credits with all standard features and weapons. Poor availability; outside of the Republic only **Ichto** makes them, and at 10% more money. **Armatech** makes the dragon 'borgs exclusively use for military and police for the Republic of Japan; they are not available to the public.

---

### Standard Bionic Features (non-weapon types)

---

Note: These features are all found in the bionic and cybernetic sections of the *Rifts RPG*.

1. Bionic lung with gas filter & oxygen storage cell
2. Built-in language translator
3. Built-in loudspeaker
4. Built-in radio receiver & transmitter
5. Clock calendar

- 6. Gyro-compass
- 7. Modulating voice synthesizer
- 8. Multi-optic eyes
- 9. Psionic electromagnetic dampers
- 10. Universal headjack with amplified hearing and sound filtration.
- 11. Prehensile tail (with vibro-blades)

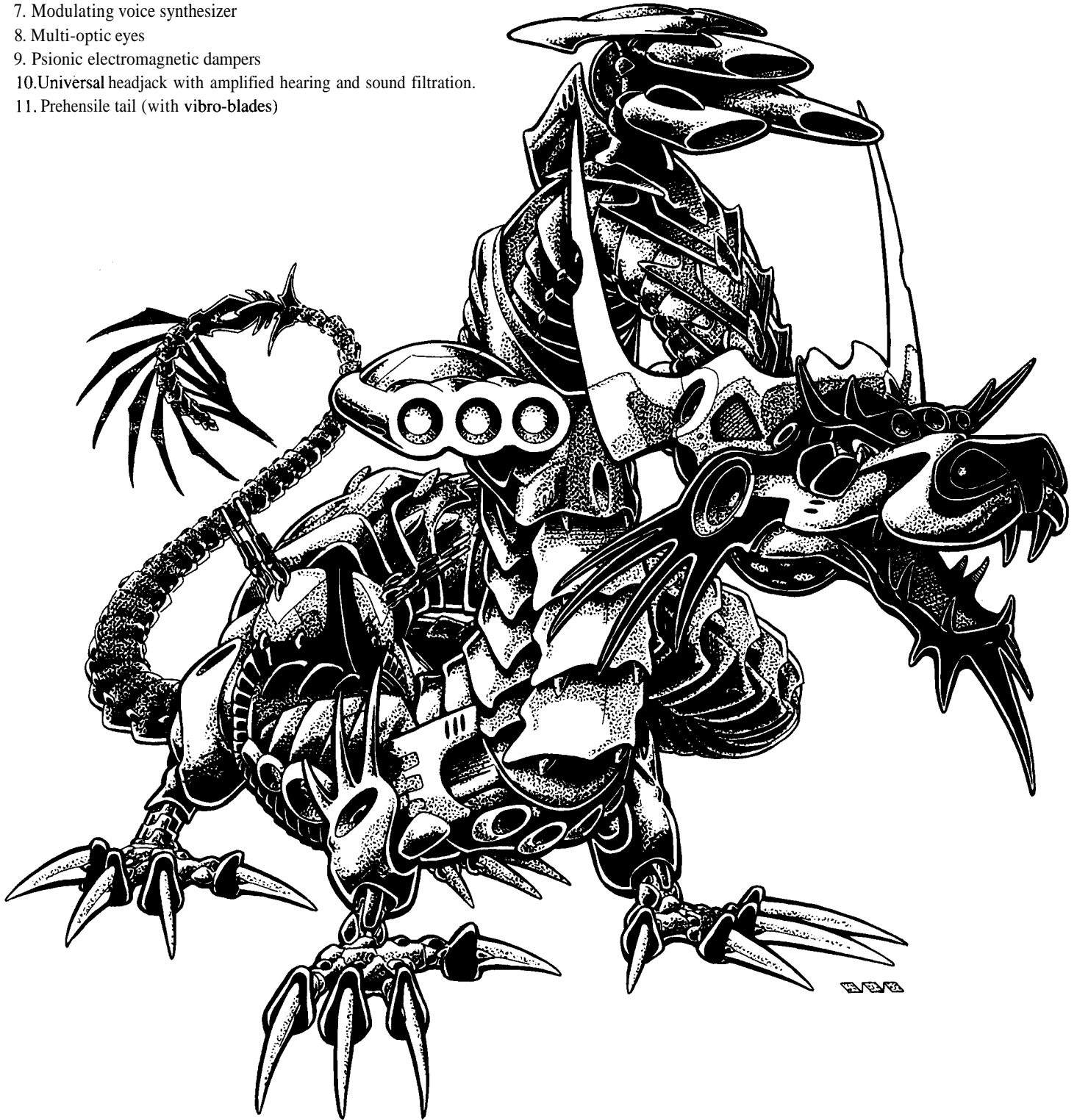

## Weapon Systems

**1. Triple-Barrelled Particle Beam Gun:** This heavy weapon system is the main gun of the 'borg.

Primary Purpose: Anti-armor, Assault.

Mega-Damage: 1D6×10+10 M.D. per triple blast; each individual gun does 4D6 M.D.

Attacks Per Melee Round: Total hand to hand melee actions.

Range: 3000 feet (915 m).

Payload: Effectively Unlimited.

**2. Mini-Missile Launchers (2):** A mini-missile launcher is mounted on each side.

Primary Purpose: Anti-aircraft; Anti-armor.

Secondary Purpose: Defense.

Mega-Damage: Varies with missile type.

Rate of Fire: One at a time, or in volleys of two, three or six.

Effective Range: About one mile.

Payload: Six total; three per launcher.

**3. Double Laser Turrets (2):** The long flanks of the Imperial are protected by these two dual laser mini-turrets. The turrets can swivel to fire directly in front, as well as the sides and rear and straight up.

Primary Purpose: Anti-personnel, Anti-aircraft.

Secondary Purpose: Defense.

Mega-Damage: Each double laser blast inflicts 4D6 M.D.; a simultaneous two-turret blast does 1D6×10M.D. (counts as two melee attacks/actions).

Rate of Fire: Equal to the total number of hand to hand attacks.

Effective Range: 4000 feet (1200 m)

Payload: Effectively unlimited.

**4. Head lasers:** Mounted above the eyes is a row of three laser gun, used to engage targets at short ranges. If the head takes more than 5 points of damage, one of the guns will be put out of commission; 15 or more points of mega-damage will destroy this weapon system.

Primary Purpose: Anti-cyborg.

Secondary Purpose: Defense.

Mega-Damage: Single beam does 2D6 M.D.; simultaneous triple beam blast inflicts 6D6 M.D.

Rate of Fire: Equal to the total number of hand to hand attacks..

Effective Range: 1000 feet (305 m).

Payload: Effectively Unlimited.

**5. Smoke Dispenser:** Four tubes on the lower front torso/underbelly of the dragon can release a variety of gases. The most common gases include smoke, mace, tear gas **tranquilizer/sleep**, fire-extinguishing foam, etc. Same effects as the chemical spray bionic system.

Primary Purpose: Chemical warfare.

Secondary Purpose: Defense.

Mega-Damage: Varies with gas type.

Rate of Fire: Equal to the total number of hand to hand attacks.

Effective Range: Each gas release/attack covers a 30 foot (9 m) area. Additional attacks add a similar amount to the air.

Payload: Four canisters, each with 10 releases/attacks. Different gases can be put into different canisters (up to four different gases, one in each canister).

**6. Vibro-Claws/Vibro-Tail:** The cybernetic forelegs and hind legs, and the end of the tail, are all tipped with **vibro-blades**, each attack inflicts 3D6 M.D. The tail can be used to feel around narrow openings, grab small objects, slash at foes, parry, or entangle. Tail strike (blunt) 6D6 S.D.C.; restrained attack does half damage.

**7. Hand to Hand Combat:** Rather than use a weapon, the cyborg can engage in mega-damage hand to hand combat. Remember, although sheathed in M.D. body armor and weapons, the cyborg's physical strength is S.D.C. based except for the occasional special attack such as power punch.

Attacks per Melee Round: Equal to the character's hand to hand combat skill selection and experience, +1 additional attack per melee (includes tail bonuses).

Combat Bonuses: +1 on initiative, +1 to parry, +2 to dodge, +2 to pull punch, and +2 to save vs horror factor; plus P.P. 23 bonus of +4 to strike, parry and dodge.

**Damage:**

Restrained Punch — 1D6+15 S.D.C.

Full Strength Punch — 3D6+15 S.D.C

Power Punch — 1D4 M.D. (counts as 2 melee attacks)

Head Butt — 2D6 S.D.C.

Kick — 4D6+15 S.D.C.

Jump Kick/Leap Attack — 2D4 M.D. (counts as 2 melee attacks)

Judo Style Throw/Flip — 3D6 S.D.C.

Full Speed Ram/Body Block — 1D4 M.D. (counts as 2 melee attacks)

Also see **vibro-blade** tail Mega-damage.

**8. Typical Training/Skills:** See the Cyborg Soldier O.C.C. for complete details. Those assigned to demolitions automatically get demolitions disposal and demolitions (both +10%) as extra skills.

---

# "Flame Cloud" Attack 'Borg

---

Like the Imperial **'borg**, the Flame Cloud is built along the lines of a serpent or true dragon rather than a **humanoid**. This cyborg has the most advanced flight system available, although it has no wings — the designers decided that at the near-supersonic speeds the cyborg could attain, wings would only add stress. Thus, although the Flame Cloud is extremely fast, it is not highly **maneuverable** unless it drops to more moderate cruising speeds (typically **60-100 mph/96-160 kph**). The jet **thrusters** also have powerful anti-aircraft lasers. The Flame Cloud's name originates from its favorite air-to-ground attack; a swooping dive accompanied by a long blast of M.D.C. flame, coming from the mouth. Two particle beam cannons mounted on the tail complete the armament of the dragon **'borg**. These flying 'borgs often fight side by side with SAMAS and other flying power armor. A common tactic is to have one or two Flame Clouds strafe jungle or forested areas to "flush out" monsters or demons, which are then attacked by the more heavily armed troopers.

The Flame Cloud **'borgs** are just as likely as the Imperial **'borgs** to lose their sanity due to the extreme inhumanity of their metallic bodies (see the Imperial **'Borg**, above). As a result, not too many volunteers are placed in these bodies.

**Model Type:** AT-C12000, Flame Cloud.

**Class:** Full Conversion Cyborg — Heavy Air Assault

**Crew:** One human volunteer.

**M.D.C. by Location:**

\* **Hands/Feet** (2) — 20 each

Forelegs/Arms (2) — 50 each

Hind Legs (2) — 50 each

Laser **Gun** (2) — 50 each

\* **Prehensile Tail**(1) — 50 M.D.C. per 6 ft (1.8 m) length.

\*\*\* **Jet Thrusters** (2, on sides) — 120each

\* **Particle Beam Cannon** (2, on rear sides of the tail) — 70 each.

\* **Head** — 100 (reinforced)

\*\* **Main Body** — 320 **M.D.C.**; cannot wear additional body armor (built in).

\* A single asterisk indicates a difficult target to strike and the attacker must make a called shot and even then he is -3 to strike. Destroying the head of a cyborg will kill the character! However, the head is a small and difficult target to hit.

\*\* Depleting the M.D.C. of the main body will effectively destroy the artificial body, but emergency systems will keep the brain and vital organs alive for 36 hours. Recovery of the severely damaged body will enable doctors to place the character on a life support system that will keep him alive until a new bionic body (same style or other) is available for full conversion. Failure to find the damaged borg within 36 hours means the character dies. Similarly, massive amounts of damage (125 points below zero) completely destroys the borg with no hope for recovery.

\*\*\* Destroying one jet thruster will reduce maximum speed by 70% and the pilot is at -25% to all rolls. Destroying both jet thrusters will render the **'borg** unable to fly; if in the air, he will crash.

**Speed**

Running: 120 **mph** (192 km) on four legs; drops to 20 **mph** (32 kph) on two legs.

Leaping: The powerful snake body can spring forward, capable of leap-

ing 30 feet (9 m) high or lengthwise. A running leap adds 1D4×10 additional yards/meters.

**Flying:** 500 mph (800 kph) maximum. While flying at maximum speed (300-500 mph/480-800 kph), the dragon 'borg cannot maneuver; limited to flying in a straight line only. It is hard to hit the fast-moving cyborg (requires a called shot at -2), but the character cannot parry or dodge! At lower speeds it can act normally. Cruising speed is 200 mph (320 kph).

**Range:** The **thrusters** can only fly at the maximum speeds for 8 hours before needing to cool off, or 24 hours at cruising speeds. Can travel indefinitely at cruising speeds with frequent rest stops.

#### Statistical Data

**Height:** 5 feet (1.5 m) while on all fours. If rearing up on its hind legs, the cyborg can stand 9 feet (2.7 m) tall.

**Width:** 2 1/2 feet (0.75 m) for the body itself. The jet thrusters add an additional 5 feet (1.5 m) to the sides.

**Length:** 24 feet (7.2 m) from head to tail.

**Weight:** 1500 lbs (675 kg)

**Physical Attributes:** Equal to a P.S. 24, P.P. 22, Spd 176.

**Power System:** Nuclear, average life is 20 years.

**Market Cost:** Twelve million credits with all standard features and weapons. Poor availability; outside of the Republic only **Ichto** makes them, and at 10% more money. **Armatech** makes the dragon 'borgs exclusively for the military and police of the Republic of Japan; they are not available to the public.

---

## Standard Bionic Features (non-weapon types)

---

**Note:** These features are all found in the bionic and cybernetic sections of the Rifts RPG.

1. Bionic lung with gas filter & oxygen storage cell
2. Built-in language translator
3. Built-in loudspeaker
4. Built-in radio receiver & transmitter
5. Clock calendar
6. Gyro-compass
7. Multi-optic eyes
8. Psionic electromagnetic dampers
9. Universal headjack with amplified hearing and sound filtration.
10. Prehensile tail (with **vibro-blades**).

## Weapon Systems

**1. Flame Breath Plasma System:** A powerful plasma projector is mounted in the head of the cyborg, enabling it to breathe jets of plasma from its mouth. Used mostly to strafe ground targets.

Primary Purpose: Anti-Armor, Assault.

Mega-Damage: 1D6×10 M.D. per flame blast. The flame will also start fires if used against anything flammable (dry forest grasslands, wooden huts, etc.).

Attacks Per Melee Round: Total hand to hand melee actions.

Range: 2000 feet (610 m).

Payload: Effectively Unlimited.

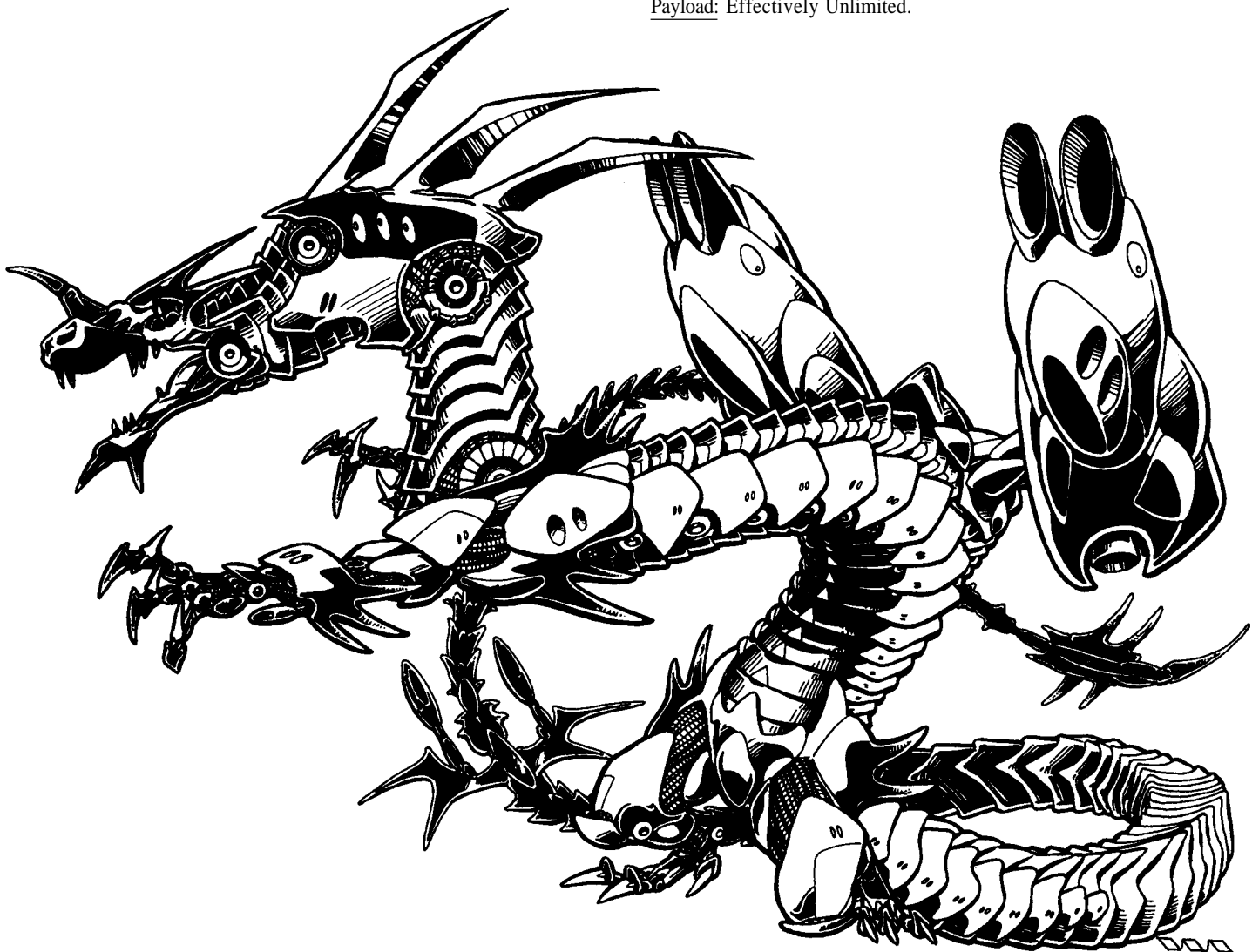

**2. Laser Guns (2):** Two lasers are mounted on the jet **thrusters**. The firing ports are built on the sides of the exhaust system.

Primary Purpose: Anti-aircraft; Anti-armor.

Secondary Purpose: Defense.

Mega-Damage: 4D6 M.D. per blast.

Rate of Fire: Equal to the total number of hand to hand attacks.

Effective Range: 4000 feet (1200 m)

Payload: Effectively unlimited.

**3. Tail Double Particle Beam Cannon:** These two beam cannon are mounted on the tail, where they can be rotated to aim in any direction.

Primary Purpose: Anti-armor, anti-aircraft.

Secondary Purpose: Defense.

Mega-Damage: Each double particle beam blast inflicts 1D4×10+10 M.D. A single blast does 4D6 M.D.

Rate of Fire: Equal to the total number of hand to hand attacks.

Effective Range: 4000 feet (1200 m)

Payload: Effectively unlimited.

**4. Vibro-Claws/Vibro-Tail:** The cybernetic forelegs and hind legs, and the end of the tail, are all tipped with **vibro-blades**; each attack inflicts 3D6 M.D. The tail can be used to feel around narrow openings, grab small objects, slash at foes, parry, or entangle. Tail strike (blunt) 6D6 S.D.C.; restrained attacks do half damage.

**5. Hand to Hand Combat:** Rather than use a weapon, the cyborg can

engage in mega-damage hand to hand combat. Remember, although sheathed in M.D. body armor and weapons, the cyborg's physical strength is S.D.C. based except for the occasional special attack such as a power punch.

Attacks per Melee Round: Equal to the character's hand to hand combat skill selection and experience, +1 additional attack per melee (includes tail bonuses).

Combat Bonuses: +1 on initiative, (+2 to initiative in the air), +1 to parry, +1 to dodge, +2 to dodge in the air (if flying at below cruise speed), +2 to pull punch, and +2 to save vs horror factor; plus P.P. 23 bonus of +4 to strike, parry and dodge.

Damage:

Restrained Punch — 1D6+13 S.D.C.

Full Strength Punch — 3D6+13 S.D.C.

Power Punch — 1D4 M.D. (counts as 2 melee attacks)

Head Butt — 2D6 S.D.C.

Kick — 4D6+13 S.D.C.

Jump Kick/Leap Attack — 2D4 M.D. (counts as 2 melee attacks)

Judo Style Throw/Flip — 3D6 S.D.C.

Full Speed Ram/Body Block — 1D4 M.D. (counts as 2 melee attacks)

Also see **vibro-blade** tail Mega-damage.

**6. Typical Training/Skills:** See the Cyborg Soldier O.C.C. for complete details. Those assigned to demolitions automatically get demolitions disposal and demolitions (both +10%) as extra skills.

---

# Cybernetics & Bionics

---

## Cybernetic Implants & Enhancements

**Note:** The following cybernetic items, plus those found in the Rifts RPG, Triax, and Rifts Underseas, are available to **cyberoids**, soldiers, meres and adventurers as implants. A few have been reprinted for your convenience.

**Bio-Comp self-monitoring system:** Nano-implants tied to a tiny computer system monitors, measures and transmits fundamental physiologic information about the person it is implanted in. The data is typically displayed on a wristwatch or bracelet style monitor, but can also be displayed and recorded on a computer, portable bio-scan or portable laboratory via a finger or headjack.

Data includes pulse rate, blood pressure, body temperature, blood sugar level, respiratory rate and difficulty breathing, and the presence of foreign elements in the bloodstream (indicating the presence of drugs or poison). **Cost:** 2500 credits.

**Cosmetic Implants:** These are artificial implants that are used for cosmetic purposes, such as changing the shape of one's nose, ears, chin, cheeks, breasts, etc. They are cybernetic because most of these unique implants can either change into two or three shapes, altering the appearance (but not enough to be considered a disguise) or to adjust to a particular environment or condition. For example, a nose or breasts might flatten to prevent damage from a fall or to better fit a helmet or evening gown; eyes might change color with the charac-

ter's mood or the amount of light, and so on. Likewise, a nose, ear or mouth implant might be tied to other cybernetic implants or attachments. **Cost:** Varies with the type of cosmetic surgery done; typically 2000 to 8,000 credits.

**Computer Virus Carrier (illegal):** A computer program tied to any cybernetic computer jack that, when engaged, releases one from as many as six available computer viruses. All are variations on known viruses and will have limited effectiveness, especially against professional systems. Popular among hackers, spies and ninja. **Success Ratio:** 71% civilian, 10% corporate, 1% police or corporations with state of the art security, and ineffective against military computers. Reduces hacking time by 33%. **Cost:** Varies; typically 41,000 to 65,000 credits.

The penalty for this crime varies with the seriousness of the crime and can include a 5000-10,000 credit fine, a criminal record for using illegal **cyberware** and removal of the illegal implant (at the cost of the perpetrator). Repeat offenders or those engaged in espionage (industrial or government) face a prison sentence that can range from 2-20 years depending on the seriousness of the incident.

**Computer Hacker Encoder (illegal):** A computer program tied to any type of computer jack that, when engaged, runs a special series of code breaking programs. Popular among hackers, spies and ninja. **Success Ratio:** 93% civilian, 50% corporate, 7% police or corporations with state of the art security, and 2% military. Reduces hacking time by 33%. **Cost:** Varies; typically 41,000 to 65,000 credits.

The penalty for this crime varies with the seriousness of the crime and can include a 5000-10,000 credit fine, a criminal record

for using illegal **cyberware** and removal of the illegal implant (at the cost of the perpetrator). Repeat offenders or those engaged in espionage (industrial or government) face a prison sentence that can range from 2-20 years depending on the seriousness of the incident.

**Computerized Telephone Jack (illegal):** The implant enables the "jacker" to plug-in and use public telephones, telephone lines and fax machines without having to pay. Most communication systems have a protection system that will indicate illegal "jacking" and trace the location of the user within 1D4 minutes. This item is immensely popular among teenage **Cyberoids** and hackers. **Cost:** 500 credits.

The penalty for this crime is a 500 credit fine, a criminal record for using illegal cyberware and removal of the illegal implant (at the cost of the perpetrator).

**Cyberware Networking:** A hardware implant and program that allows the user to interface, via computerjack, with another person's cybernetics or bionics and listen in or monitor his/her communications and computer systems, including sensor data, computer data or radio transmissions. As many as three people can network, but must maintain a physical connection to remain interfaced. The networking does not enable one person to seize control of the cyberware of another person, only the ability to eavesdrop. Popular among hackers, spies and ninja, and used by the police, security experts and, to a more limited degree, the military. **Cost:** 75,000 credits.

**Cyber-Drone (highly illegal!):** This is an implant and program similar to the cyberware network but enables the user not only to eavesdrop and steal data, but to seize control of the cyberware or bionics! The **Cyberoid** or 'borg loses complete contact with his **cybernetic/bionic** systems (which may blind some characters) and can only respond with his mind and natural body. Criminals who use the cyber-drone will usually take precautions to otherwise incapacitate or restrain their victim (often something as simple as a pair of handcuffs or a threat like having a gun pressed to the victim's head saying he will kill him if he doesn't cooperate). The villain can then activate and use any weapons or artificial systems (except bio-systems) at his victim's disposal. In the case of cyborgs, this includes motor movement of the limbs and weapons, making the borg little more than a helpless puppet. This item was created by tech-ninjas and is popular among ninja, spies, assassins and terrorists. **Cost:** Half a million or more; extremely rare even among the tech-ninja clan that developed it.

This is considered a heinous crime and punishable by 20-40 years in prison without parole. Depending on the severity of the incident, the degree of damage and injury or death, the perpetrator may face the death penalty!

**Data Chip (illegal):** This device was originally developed by the military and is illegal for civilian use (which does stop **Cyberoids**). A chip is implanted beneath the character's skull on the surface of the brain. When combined with an optic nerve video implant, H.U.D. visor, or cyberware networking, the character can mentally access the information on the implant, which then appears on the visor or eye! The memory recorder is used to store maps, floor plans, schematics/technological readouts, simple repair or medical procedures and so on. Up to one meg of data can be stored.

The data cannot be changed or added to unless the character is equipped with cyberware networking (rare). Consequently, to get new data, the character must undergo brain surgery to remove the old chip and implant the new. Only one chip can be implanted at a time. Two or more interfere with each other and cause random blackouts, mental confusion (-30% on all skills, and -4 on all bonuses), painful headaches and eventually, madness. Uploading of in-

formation to the memory recorder is accomplished through the use of a regular computer terminal and a universal **headjack**. **Cost:** 26,000 credits. Note: This implant interferes with psionics, reducing range and duration by 10%!

The penalty for this crime is a 1500 credit fine, a criminal record for using illegal cyberware and removal of the illegal implant (at the cost of the perpetrator).

**Depth Gauge:** An implant popular among SCUBA divers, deep-sea explorers and fishermen. The implant measures the ocean's depth and water pressure. The inexpensive model (600 credits) vibrates when entering dangerous depths, while the more expensive, standard model is hooked to an ear implant or radio chip and transmits a "pinging" sound for every foot of depth travelled and an audio (or HUD to **artificial** eyes) statement of depth at every 10 feet (3 m). A warning sounds when entering dangerous depths. **Cost:** 4000 credits.

**Internal Comp-Calculator:** A tiny computerized calculator usually connected to a headjack, ear implant or artificial eye. The computer responds to spoken, radio or computer transmitted mathematical equations. The answer is transmitted through the headjack, ear or eye implant. **Cost:** Basic math (addition, subtraction, multiplication, division and fractions): 1000 credits. Advanced math (algebra, geometry, and calculus): 5000 credits.

**Metal Detector:** Usually built into the hand or forearm. By waving the arm over an area or a person's body, it will detect metal fragments, coins, concealed weapons, and bionics. This device does have a limited range of two feet (0.6 m) and items covered in synthetic or real flesh only have a 10% chance of detection. **Cost:** 4500 credits.

**Power Booster (illegal):** A miniature **E-clip** implanted in or attached to the body. It is usually used as a back-up power supply for cybernetic tools and weapon systems. Typical weapon payload: 20 energy blasts. **Cost:** 25,000 credits.

**Radio Chip:** Usually implanted in the ear or at the base of the neck. The chip is a radio receiver that enables the character to listen to public radio and television bands of transmission. Most **Cyberoids** have it installed for recreational purposes. **Cost:** 1200 credits. The chip can be converted to pick-up a wide band of transmissions, including most police and military bands, for the cost of 3000 credits.

**Radio & Scrambler Implant (experimental & illegal):** An implant with organic circuitry developed by the military that enables the user to interface with a specially modified radio through mental control. For most cyborgs, the shortwave radio will be housed in a compartment on the armored back. It has a range of 100 miles (160 km), can broadcast on 800 frequencies and automatically scrambles and decodes all transmissions. It can also send scrambled and coded messages. **Cost:** 80,000 credits for implant and an additional 20,000 credits for the radio. Note: This implant interferes with psionics, reducing range and duration by 75%!

The penalty for this crime is a 10,000 credit fine, a criminal record for using illegal cyberware and removal of the illegal implant (at the cost of the perpetrator). Repeat offenders or those caught using the device for the commission of a crime, face 2D4 years of prison time.

**Signal Booster:** A small power supply usually implanted to boost the strength/signals of computer and communication implants; increases the clarity of sound and increase range by 25%. **Cost:** 1200 credits.

**Security Clearance Chip:** A variety of identification (ID) chips are used by the police, military and corporate security forces. The encoded chip can be implanted under the skin anywhere on the body, but usually in the neck, behind the ear, nose, hand or forearm. It is



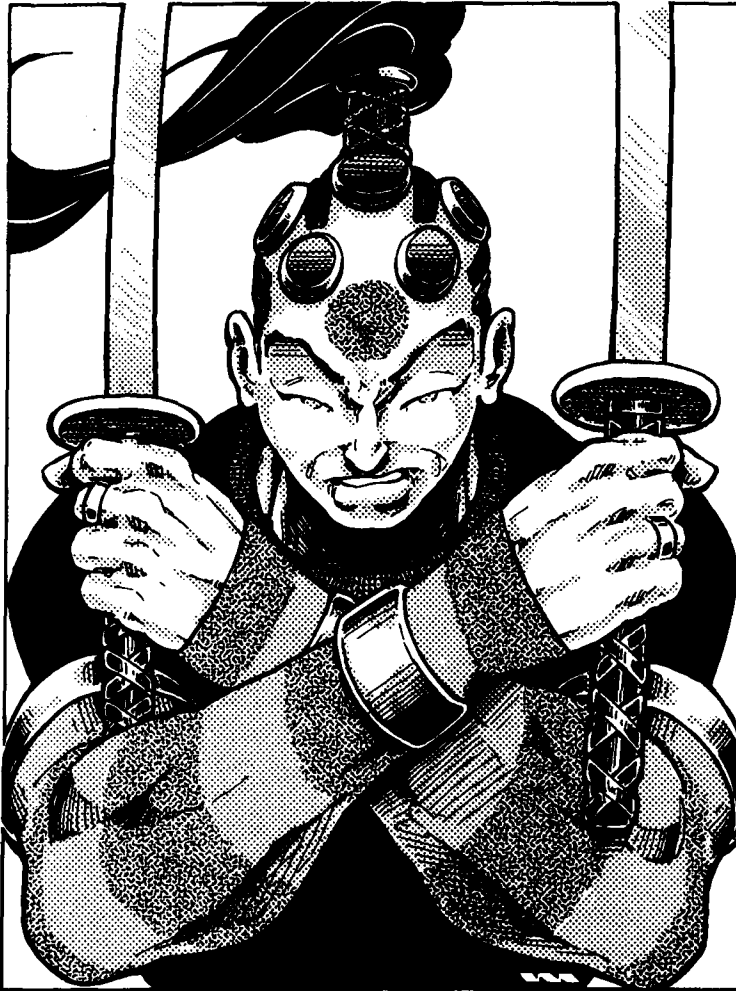

recognized by security devices and detection systems to allow those with their correct security chip access to particular areas of a building, office and even access to specific vehicles, computers and machines (the item doesn't **respond/locks** out a person with the wrong or no chip). **Cost:** Varies with the quality and sophistication of the chip: Basic chip: 500 credits, top security: 1500 credits, military quality security: 2500 credits.

**Snaps, hooks, tabs, loops, buckles and Velcro body attachments** are amazingly popular among the **Cyberoids** of Japan, especially teenagers and young adults. These city rats use them for both ornamentation (like body peircing) and as functional accessories. Snaps, hooks, etc., are used to secure wigs and hair-peices, to hold (and often to conceal when placed on the scalp, **underarms**, and legs) small items like **knives**, ice picks, black-jacks, micro-lasers, **mini-tools**, markers, lighters, flashlights, computer disks, spy cameras, and so on. Many of these implants are woven or bonded to the flesh and are resistant to tearing, sagging, or breaking. The best can hold up items up to one pound with little or no discomfort. The most common location for these attachments are the scalp of the head, chest, arms, under the arms and the legs.

**Average Cost:** 100 credits per each **attachment/holder**. They can be removed for the same cost with minimal, sometimes no, scarring.

**Tracer Chip (illegal):** Tracer chips are miniature tracking devices usually implanted under the skin of the scalp, behind the ear or under the arm. The chip emits a signal that can be tracked with a portable tracking **monitor/locator**. The range of the signal in the city is roughly two miles (3.2 km), but in rural areas or wildernesses it can be traced for up to five miles (8 km).

The chip usually has a life of at least seven days or can draw power from existing implants to transmit indefinitely. The military **occasionally** uses these chips with a scrambler on soldiers, so they can track them for extraction from the field, but this is seldom done because the enemy can also track the signal to locate the soldier. The police occasionally use the device to follow suspects or keep track of felons on parole. Again the effectiveness of the device is minimal as the implant can be easily detected with simple electronic bug detectors and is just as easily removed; the implant is about the size of a shirt button. **Cost:** 800 credits plus 250 credits to install or remove.

## Bionic Weapons & Tools

**Note:** The following bionic items, plus those found in the Rifts RPG, **Triax**, and **Rifts Underseas**, are available the **Cyberoids**, soldiers, meres and adventurers as implants. Remember, bionics are heavy-duty cybernetic systems designed for use with cyborgs and for war. They cannot be used as implants for characters who are not partial or full conversion **'borgs**.

**Chest Blaster:** A mega-damage laser blaster fitted onto the bionic chest on a nozzle-style mini-turret. The blaster can be moved 45 degrees in any direction to aim at specific targets. Up to three of these laser weapons can be mounted on a bionic chest.

**Mega-Damage:** 3D6 M.D.

**Maximum Effective Range:** 800 feet (244 m).

**Rate of Fire:** Equal to the number of hand to hand attacks.

**Payload:** 20 shots before needing recharging. Requires four hours to recharge. The payload is greatly extended if the cyborg has an internal power supply.

**Cost:** 24,000 credits.

**Internal Energy Supply:** Not a weapon system in itself, the internal energy supply can be used to power weapon systems and greatly increase their payloads. Built into the bionic chest of a full conversion borg, the power supply will be either an electric battery or a small nuclear engine. The battery has enough energy for 500 regular blasts from any standard energy projection weapon on the cyborg; this includes the Forearm Blaster, Palm Energy Generators, Chest Blaster or Palm Weapon Link. A nuclear generator, with an average energy life of 11 years, has an effectively unlimited payload. **Cost:** 500,000 credits for an electric battery, a nuclear power supply costs one million credits.

**Internal Ammo Drum:** Basically, a secret compartment that is contained in the abdomen, lower back or chest area of a cyborg with heavy bionic replacements. Unlike the standard compartment, however, the internal ammo drum is spring-loaded and holds belted rail gun ammunition for all standard **Armatech** weapons. Rather than carrying small ammunition magazines with low payloads, the cyborg can use its own internal drum that holds 3000 rounds. It is easy to reload the ammo drum, requiring a minimum of effort, a couple of tools and a few rail gun ammunition belts. **Cost:** 5000 credits.

**Laser Beam Eye (1 or 2):** Suitable for 'bots and **'borgs**. Usually draws its energy from the artificial power source. In the instances where this feature is used, the eye (or eyes) are unusually large or a visor-like implant rather than a human-looking eye. Sometimes the entire head is over-sized. **Note:** The NGR military also has a particle beam version.

**Primary Purpose:** Assault

**Mega-Damage:** 2D6 M.D. per single eye blast or 4D6 M.D. per double blast (both eyes fire simultaneously at the same target). A double blast counts as one melee action.

Rate of Fire: Equal to the borg's total number of hand to hand attacks per melee.

Effective Range: 1000 feet (305 m)

Payload: Effectively unlimited.

Bonus: +1 to strike.

Cost: 130,000 credits.

**Palm Energy Generators:** Centered on the palm of each hand is an energy generator that fires short-range energy blasts. The palm generators are excellent back-up weapons. There are advantages to the weapons in that the cyborg will never be unarmed and the generator bores often go unnoticed. Primarily used for espionage purposes, the palm weapons are extremely popular among assassins, spies, thieves and city rats. There are several different blasters to choose from, including lasers, ion, plasma, stun or particle beams.

---

## Weapon Types, Mega-Damage & Range:

---

**1. Laser Blaster:** Mega-Damage: 1D6 M.D. per single blast, 2D6 M.D. per dual palm blast. Maximum Effective Range: 500 feet (152 m) Payload: Internal battery holds energy for 50 single blasts! Internal energy supply gives the weapon an unlimited payload. **Cost:** 25,000 credits.

**2. Ion Blaster:** Mega-Damage: 2D6 M.D. per single blast, 4D6 M.D. per dual simultaneous blast. Maximum Effective Range: 300 feet (91.5 m). Payload: Internal battery holds energy for 30 single blasts. Internal nuclear power supply gives the blaster an unlimited payload. **Cost:** 22,000 credits.

**3. Particle Beam:** Mega-Damage: 5D6 M.D. per single blast, a dual simultaneous blast inflicts 1D6x10 M.D. Maximum Effective Range: 300 feet (91.5 m). Payload: Battery holds energy for 20 single blasts. Nuclear power supply gives the blasters unlimited payload. **Cost:** 64,000 credits.

**4. Plasma Ejector:** Mega-Damage: 4D6 M.D. per single blast, dual blast inflicts 1D4x10 M.D. Maximum Effective Range: 200 feet (61.0 m). Payload: Battery has energy for 20 single blasts. Effectively unlimited with nuclear power supply. **Cost:** 45,000 credits.

**5. Stun Blaster:** S.D.C. Damage: 6D6 S.D.C. per single blast, 1D6x10 S.D.C. per dual blast. (See AT-23 Police Stun Gun description in the weapon section). Maximum Effective Range: 500 feet (152 m). Payload: Battery has energy for 50 single blasts. Payload is unlimited when used with nuclear power supply. **Cost:** 42,000 credits.

Engine: Liquid fuel supply or nuclear engine.

Maximum Effective Range: 120 miles (192 km) if liquid fuel powered. Effectively unlimited with nuclear supply except that the thrusters need cooling after 800 miles (1280 km).

Cost: 65,000 credits.

**H.U.D. Visor:** An easily removable face-plate with visor that attaches to the head of the cyborg. The visor blocks all regular vision but is attached to a multi-optics camera that relays visual data, equal to normal vision, directly to the visor. The visor has several split-screens that can display, in addition to the camera generated view, radar information, compass direction, current time, pressure/depth, oxygen levels, **floorplan** grids, and maps. The SNARLS system can even be combined with the visor feature. **Cost:** 95,000 credits.

**Internal IV Feed:** A device implanted in the torso of the character that supplies liquid nutrients directly into the bloodstream. The individual has complete control over the flow of nutrients. Most recipients of the IV feed implant will be full conversion cyborgs or special forces troopers. These characters will use the liquids for survival, when they are unable to stop to hunt for food. While the system holds only enough nutrients for 3 days, the trained soldier can stretch that amount to last for a week to ten days, twice that time for borgs. Note that the individual will be able to function but they will be uncomfortable from lingering hunger pains. After the 7-10 days are over, the character will start suffering from the effects of starvation. **Cost:** 5000 credits.

**Rebreather Lung:** A new and revolutionary oxygen storage cell that does more than store oxygen. Its special chemical process allows the lung implant to recycle breathable air. When it is not in use, the rebreather lung stores oxygen from the character's regular breathing. When oxygen is low, the storage cell releases oxygen back into the lungs. Using the stored oxygen, the character has the ability to go without breathing for 2 hours. Once the stored oxygen is used up, the chemical process starts to recycle the air, allowing it to be "re-breathed." Through this process, the character can go for 12 hours without breathing. If the character has two rebreather lung implants, the individual will be able to go without breathing fresh air for an amazing 24 hours. **Cost:** 210,000 credits per lung.

**Security Clearance Chip:** A chip with security clearance codes used in top secret military facilities, usually implanted in the recipient's head. The Republic of Japan uses the security chip, which is required in maximum security military or manufacturing facilities, although these are a fraction of the total. Workers, guards and technicians all have the chips implanted. Top military brass and the best scientists also have the chip.

Professional thieves, saboteurs, spies and assassins would love to get their hands on one security clearance chip from which a technician could easily jury-rig more. To stop theft of the chips, the military has included a small explosive charge in each chip that automatically detonates if the implant is tampered with in any way. The explosion immediately kills the individual in whom the chip was implanted, everyone else in a 5 foot (1.5 m) radius will suffer 1D4 S.D.C. **Cost:** Not available, but would sell for tens of millions on the black market.

**Underwater Propulsion:** Similar to the jet thruster system, the bionic legs or lower back can have a propulsion system installed for underwater use. The system operates in the same manner as the Underwater Propulsion Pack but has a fairly limited range unless the cyborg is also outfitted with an internal energy supply.

Maximum Speed: 50 mph (80 km).

Engine: Electric battery supply or nuclear engine.

---

## Bionic Implants & Other Features

---

**Environmental Upgrade:** The exterior of the cyborg is sealed to keep oxygen from leaking and to protect from outside contaminants and toxins. Radiation shielding and internal temperature control are included in this upgrade which enables the cyborg to operate in hostile environments like underwater or outer space. The process of sealing the exterior includes the addition of extra armor plating; a bonus of 25 M.D.C. to the main body and 10 M.D.C. for each limb. **Cost:** 68,000 credits.

**Aerial Jet Thrusters:** A jet propulsion system can be installed in a full conversion cyborg, found either in the legs or the lower back. With just a thought, the individual can hover or fly at a high speed. Unless the character also has the Internal Power Supply feature, the running time of the jet thrusters, between fuelling, is extremely short. In order to operate the jet system, the character must have the pilot jet pack skill.

Maximum Speed: 120mph (192 km).



Maximum Effective Range: 150 miles (240 km) if battery operated. The underwater propulsion system can run indefinitely with a nuclear power supply, the only factor restricting range is the oxygen supply of the pilot. Cost: 72,000 credits.

# High-Tech Weapons

By Patrick Nowak & Kevin Siembieda

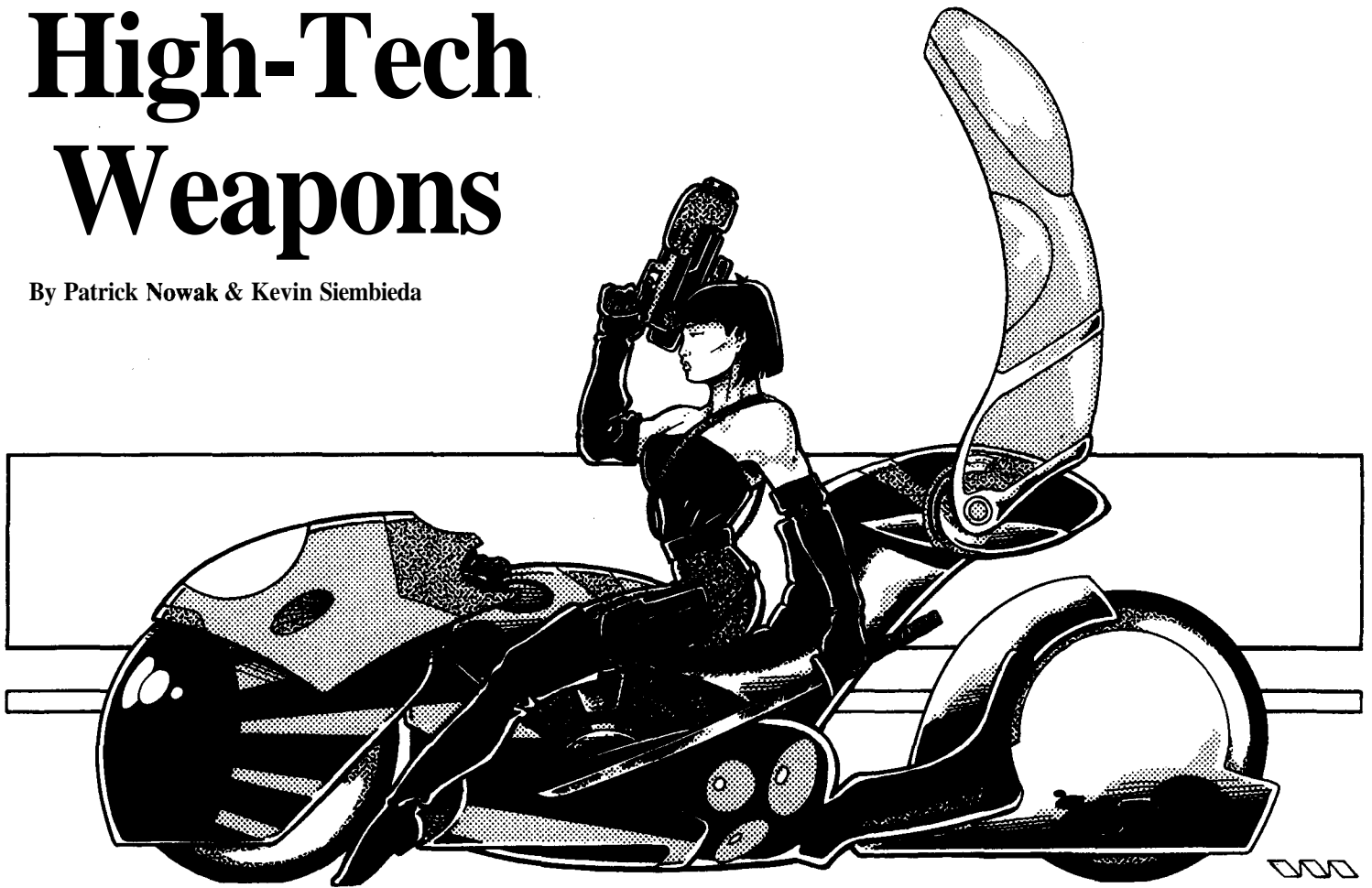

## ArmaTech Industries

ArmaTech is the old international name used by *Akizuki International*, a weapons manufacturer that grew to prominence in the 21st Century. It became a world leader in the development of laser technology, particle acceleration, bionics and **nano-technology** for the application of weapon systems, power armor, and medicine. ArmaTech had research, development and manufacturing facilities around the world including Germany, Mexico, America and Canada. In fact, it was one of the very few foreign manufacturers who actually won a US Government contract to perfect and develop variations for the Glitter Boy and the experimental (at the time) SAMAS power armor (Strategic Armored Military Assault System)!

A wide variety of weapons are produced by this company in the Post-Rifts world, including bionic weapons and components, vibroblades, rail guns, lasers and other energy weapons. They are produced and sold to the military, police, and **corporations** under strict government supervision and control. Sales to corporations include security forces, security companies, bodyguards, and executives, especially those of samurai descent.

ArmaTech does not manufacture or distribute weapons to any of the non-allied kingdoms outside the Republic of Japan and never sells to mercenaries or outsiders. In this regard, the company can be considered a government agency, or at best, an exclusive government contractor that works for and under the jurisdiction of the Defense Department. Of course, ninjas, ronins, mercenaries, adventurers, criminals, and the occasional merchant sometimes acquire, use, sell or trade ArmaTech

weapons, armor and equipment. Smugglers and individuals found guilty of selling weapons or technology to criminals, mercenaries, private individuals, or forces outside of the Republic, are executed (after a swift trial) for treason and crimes against the State.

Despite the dangers involved, there are several weapon smuggling operations and black market organizations throughout Japan. Each dealer will have different items for sale and varying degrees of security. Some are nothing more than bandits or mercenaries selling stolen goods or the spoils of war. Others are professional smugglers and arms dealers who "acquire," sell, repair and recharge weapons and munitions for a living. Professionals are often members of criminal organizations typically found in Nagasaki, and in and around independent kingdoms near the Republic of Japan.

As in most modern cities, it is illegal for the average citizen to carry military issue weapons or **sidearms**. Gun control in the Republic is strict. Less than 2% of the population legally owns a weapon while an estimated 4% illegally own modern weapons; only the police and military are authorized to carry and use high-tech weaponry.

Adventurers/visitors who enter the Republic and are found to be carrying ArmaTech equipment are detained and questioned by the authorities (local police or military) about how and from whom they acquired the items. Characters who cooperate will find the questioning to be brief and inoffensive. Characters who don't cooperate or who act rudely or argumentative will be treated roughly and may be detained for days of questioning. In either case, it will be explained that the weapons are illegal contraband and must be confiscated without compensation — it's not the government's problem that the characters purchased or stole illegal items, and ignorance of the law is not a defense or an excuse. Any character who refuses or physically resists handing over the contraband will be attacked and forced to comply. **Ultimately**, the illegal military paraphernalia will be recovered or destroyed one way or another. Those

who use deadly force to resist will be forcibly subdued or slain. If the lawbreaker should escape, he or she will be considered an armed and dangerous criminal or refugee and will become the subject of a manhunt (see the Japanese SAMAS). If the character who resists compliance with the contraband law should survive combat and is captured (or surrenders at any time), the contraband will be confiscated, further interrogation will follow, and the person may be charged with smuggling or other crimes. This can lead to a prison term, fine, and/or being banned from the nation. However, the authorities understand the reluctance shown by an adventurer at having to turning over his possessions, especially without compensation. As a result, they usually exhibit amazing patience, understanding and compassion for "outsiders" who aren't familiar with their laws. Even if illegal weapons and contraband have to be taken by force (they won't let people with contraband just leave the area), the characters are often held harmless for their ignorance. Most heated arguments or scuffles that may have ensued are ignored and no charges are made against them. Unless a law enforcer or bystander is killed, or great amounts of property damage are caused, the offending characters will eventually be allowed to enter the city; disarmed of course. Note that murder and deliberate action to inflict great bodily harm are serious offenses subject to a speedy trial and a quick execution or prison sentence for those found guilty.

---

## H-Brand

The only other high-tech weapons manufacturer of note on the entire island chain is a small company nestled among the independent kingdom of Otomo. Its products are known simply as **H-Brand** weapons. Some are original designs but most are "knock-offs" of ArmaTech and foreign weapons acquired from occasional visitors and seafarers. In addition to mega-damage weapons and armor, H-Brand also produces a large number of semi-automatic and automatic S.D.C. weapons and specialty items like high-tech (M.D. and S.D.C.) bows, arrows, vibro-weapons and explosives. Its products are of a lower quality than ArmaTech, but are generally good, reliable items.

---

## Odds & Ends

**All Armatech brand weapons** have the prefix "AT" and are of superior quality.

**Most, but not all, H-Brand weapons** have the prefix "H," are of fair to good quality, and are mainly cheap knock-offs of ArmaTech weapons.

A "knock-off" is an exact or close to exact copy of another manufacturer. However, most knock-offs are cheaper versions that use inferior (cheaper) materials or labor, so while they may cost less (or the same), the quality of the product is also less (doesn't look as nice, is likely to have 1D6×10% less M.D.C., is likely to be 1D4×10% heavier, may jam more frequently, etc.)

The occasional other weaponsmith can be found here and there outside of the Republic of Japan, but they are extremely uncommon and vary in quality. These operators repair and recharge energy weapons and make S.D.C. ammunition and weapons. Remember, technology is viewed with disdain in the kingdoms of the New Empire.

**The M.D.C. of Typical Items:** Unless stated otherwise, the average energy pistol or vibro-blade has 15 M.D., an energy rifle 30 to 40 M.D.C., a rail gun 50 to 75 M.D.C., while giant-sized weapons for bogs, bots and power armor usually have 100 M.D.C.

**Weapon Prices & Availability:** ArmaTech weapons are most common in the Republic of Japan, and although officially restricted to law enforcement and military authorities, they can be purchased from smugglers and illegal weapon dealers found in the cities. City prices vary according to the current market and from one seller to the next. The most

common items are vibro-weapons and pistols. Costs can be anywhere from plus or minus 10% to 20% of those listed in the weapon descriptions.

ArmaTech weapons can also be purchased outside the Republic of Japan, but typically cost 50% to 100% more than the list price. In wilderness areas it will be difficult to **find** someone willing to part with a weapon, let alone get the market price. H-Brand weapons and magic items are much more common among independent kingdoms as well as in wilderness and monster dominated regions. **Note:** The occasional weapon, armor or vehicle of the New Navy (see *Rifts Underseas*), Tritonia, Triax or **Splugorth/Kittani** manufacture finds their way to Japan. The prices for these weapons are usually comparable to ArmaTech items but are *sometimes* considered "special and rare" and can cost as much as 300% more.

**Currency:** Credits are usually recorded and carried on plastic credit cards or debit cards. A credit card accesses the **money/credits** kept in a recognized bank, or other lending institution, and funds are automatically transferred from the cardholder's account to the merchant. Additional funds can be added to the account at any time.

A debit card starts with a finite amount of **money/credit**. Each purchase reduces the amount of credits on that card. When reduced to zero, the card is worthless. Additional funds cannot be added to a debit card, but a new card (say with credits from the sale of an ancient artifact or weapons) can be created by most reputable merchants and governments. Many adventurers and mercenaries prefer the debit card system because the funds are guaranteed but in an anonymous account, so credit accounts cannot be frozen or the credit holder identified (anyone with the debit card can use it).

Both types of cards are common in North America and Germany. *Universal Credits* are accepted throughout the Coalition States, many major North American cities and kingdoms, including Lazlo and Tolkeen, as well as in the NGR (which has growing economic and political ties to the CS). However, many communities have their own credit system, and some use a barter system of goods or services rather than a "credit" banking system. Not all communities accept even Universal Credits.

**The Republic of Japan** and most of the technology based Japanese kingdoms have a credit system based on the old Yen. No other types of credit are accepted. It is a closed and contained society. Also remember, Rifts Japan has virtually no contact with the outside world, although encountering the New Navy and/or Tritonia seems inevitable.

**The New Empire of Japan** are anti-technology and have given up all things linked to the modern world, including credits. This means they trade goods (gold, silver, gems, food, weapons, magic, etc.) and services (labor, protection, etc.) for other goods and services. However, in the context of the game, most of these goods and services will be assigned an equivalent value in credits so players can accurately assess the cost/value of things being traded.

**Notes about lasers:** For some reason, I've recently been asked a number of questions about energy weapons that I'd like to address (Kevin Siembieda).

**1. Do laser weapons have a recoil when fired?** No, there is no recoil from a laser weapon. One can think of a laser as a glorified, high-powered flashlight — and flashlights don't have a recoil when you turn 'em on.

**2. Do laser weapons make a noise when fired?** Other than the soft click from the pull of the trigger, no. It is a completely silent weapon! This makes it ideal for assassins and sneak attacks (of course, the sound of victims screaming, moaning, falling bodies, possible explosions ignited from the attack, etc. will make noise). We can blame the notion of lasers and energy weapons making noise from great film classics like **Star Wars** and **Star Trek**. Adding a sound-effect for lasers adds to the sensation of power and excitement in film. Silent attacks seem awkward (humans are used to hearing sound) and less dramatic. So if you want lasers to make a sound for dramatic effect, go ahead, but no, in the real

world they wouldn't make any noise. Staying with the flashlight analogy, a flashlight or searchlight does not make a "Zap," "Zip," "Zot" or "Hum" sound when you turn it on.

**3. What about other energy weapons?** Ion, gamma, or accelerated particle beams weapons make no sound (again, except for dramatic effect) and have no recoil. Plasma weapons *do* have a kick to them similar to that of rifle, but that's because of the firing system and the immense release of energy. Energy cannons might have a squeal, sizzle or zap sound because the immense amount of energy discharged, but even then it is more likely to be the sound of the firing mechanism that makes a noise rather than the energy pulse or beam itself.

All rail guns are basically high-powered machineguns so they definitely have a "kick" and make plenty of noise like a machinegun/gatling gun. Heck, the Glitter Boy's Boom Gun makes a deafening sonic boom. Likewise, grenade/rocket launchers, missile launchers and most weapons that fire a projectile will have rapport like a rifle or shotgun.



## SNARLS Sensor System

SNARLS (Super-Natural Assault Rifle Sensor) was devised as an advanced sensor suite to give soldiers an edge in fighting the supernatural. The mechanism resembles a telescopic sight that can be attached to any rifle or rail gun in place of a scope. The sensor scans for distances, motion, heat, radiation, pheromones (scent via molecular analyzer), and detectable bio-patterns (including high levels of P.P.E.; 80 or more points) as well as using radar and other sensors to help locate and identify non-humans and invisible beings. The sensors sweep an area in front of the soldier in a 120 degree arc to a distance of 200 feet (61 m). All information gathered by the sensor are fed to a mini-computer clipped to the trooper's belt. The computer processes the data and sends a digital message display inside the soldier's helmet, or a pair of special HUD goggles or visor (direct to the artificial eyes of a borg) in less than three seconds. Special, advanced SNARLS systems include the transmission of audio data and warnings, usually sent to an ear implant or receiver in a helmet.

In addition to the basic data, a silhouette of invisible or otherwise cloaked creatures will appear on the Heads Up Display (HUD) and simulate its estimated location, distance and movement. If the soldier's helmet or augmentation has a targeting sight the computer will automatically lock onto the nearest (or desired) silhouette.

The computer also displays a *percentile number* indicating the accuracy level of the readings. A general rule of thumb is that any reading under 68% should be considered a dangerous "suspect" but not a confirmed supernatural or inhuman being. A reading of 80% to 100% is considered to be a "confirmed" **inhuman/monster** by most soldiers and a signal to engage the enemy. The SNARLS system can identify 2000 known creatures, including humans, augmented humans (juicers, crazies, borgs, mutants), so-called demons, dragons, and scores of inhuman beings common to the area. However, SNARLS only has a 1-25% success ratio in identifying shape changers, like changelings and vampires in human or animal form. The same is true for beings magically transformed into a different shape. Elves, dwarves, ogres, **simvan**, wolven, dog boys, and most S.D.C. beings will register as human or not-supernatural. High level (8+) practitioners of magic, dragons and creatures of magic may register as supernatural because of the amount of P.P.E. energy contained **and/or** channeled through their bodies.

Production is exclusively limited to Military Special Forces, with tight security. It is NOT available on the black market or from **H-Brand**. Weight: 1.2lbs (0.54 kg) for the sensor, the mini-computer weighs one pound (0.45 kg).

Maximum Effective Range: 200 feet (61 m) in a 120 degree arc. 50% margin for error beyond 200 feet, up to about 500 feet (152 m).

Mega-Damage Capacity: Sensor: 6 M.D.C., computer: 12 M.D.C.

Note: Both the sensor and computer are extremely small targets and require a called shot to hit, and even then the attacker is -4 to strike.

Penalty: Accuracy levels vary depending on the environment, sensory data, number of targets being scanned and other circumstances.

Invisible Beings: On the first **melee action/attack** the invisible creature automatically gains initiative as the computer is processing the data. Once the silhouette has appeared on the visor initiative is determined normally until the creature is **slain/subdued** or leaves the sensor range. **Note:** SNARLS cannot identify a vampire in mist or animal form.

Cost: 125,000 credits.

Note: Available only to the military and police Special Forces. SNARLS is not available on the Black Market or from H-Brand.

## Armed Forces Personnel Backpack

The standard issue backpack of the Republic's armed forces are filled with all the items necessary for a soldier to continue to survive and fight in the field. Each pack shares the same basic design and features, but three types exist, the PR-1 standard backpack, the PR-2 radio operator pack, and the PR-3 rail gunner's pack.

Cost: PR-1: 5000 credits, PR-2: 6500 credits, and 4500 credits for a fully loaded PR-3.

- M.D.C.: 20
- Contains a built-in homing beacon so that lost or separated soldiers can be tracked and rescued by the signal.
- An electromagnetic adhesive pad is built into the back of the rucksack which can be sealed to an identical pad built into the back of standard issue body armor. When the two are sealed together they cannot be separated unless one or the other is destroyed or a combined P.S. of 50 is used to pull off the pack.
- **Basic Survival Equipment:** Includes a survival knife, water purification tablets, a one quart canteen, medical kit and 5 days rations.

- The standard pack also includes one quart canteen, 3 weeks **freeze-dried** rations, portable stove, camouflage uniform of local terrain, infrared flashlight, fishing kit with basic hooks, sinkers lures and line, a waterproof thermal poncho which doubles as a tent, and water purification system that fits onto a canteen and can safely clean 200 gallons (758 litres).
- Features include a large interior compartment and three smaller exterior compartments.
- The **PR-2** has a built-in radio carrier wave amplifier which is linked to the wearer's helmet radio. With the amplifier, the range of the helmet radio is extended to 50 miles (80 km). The backpack contains the radio in addition to a basic tool kit, weapon cleaning kit, spare rifle parts and 10 standard **E-clips**. In addition, the backpack comes with one Satchel Charge, and two fragmentation hand grenades.
- The **PR-3**, main compartment is designed to fit an ammunition drum for the **AT-600** rail gun. Other than the ammunition, the pack contains only basic survival equipment in the outer pockets.

---

## Energy Clips

---

### Standard Pistol E-Clips

All **ArmaTech** pistol weapons use the same standard hand-loaded energy magazine. **H-Brand** weapons use the same standard for their pistol clips which are cheap knock-offs of **ArmaTech E-clips**. The magazines of both brands are interchangeable, although **ArmaTech** is of higher quality. They can also be used to power most bionic and cybernetic weapons.

It is interesting to note that **ArmaTech** energy clips and basic weapon designs are fundamentally the same as those used by the *Coalition States* in distant North America; evidence that the Coalition's technology is based heavily on pre-Rifts knowledge unearthed from ancient ruins and held secret by the government. Consequently, the weapons and **E-clips** of both **ArmaTech** and **H-Brand** (who steals and imitates **ArmaTech** designs) can be used in many of the weapons produced by the **CS** and most North American manufacturers (**Northern Gun**, **Wilk's**, etc.), as well as the **New Navy!** With the proper modifications, they can be used in **Triax** and **Naruni** weapons too.

Typical Payload for the pistol E-clip: 10 to 20 shots for pistols/hand-guns.

Cost: 6,500 credits for an undamaged, fully charged pistol **E-clip**. Recharging an empty clip to full power usually costs around 1200 to 2000 credits.

### Rifle & Heavy Weapon E-Clips

**Standard Rifle Clips** manufactured by **ArmaTech** and by **H-Brand** are identical, interchangeable **E-clips**. They are larger than those of pistols and cannot be used to power the smaller weapons.

Typical Payload for the rifle E-clip: 20 to 30 shots.

Cost: A typical rifle **E-clip** costs 10,000 credits when purchased new. A recharge to full power usually costs around 3000 credits.

**Energy Canisters:** Designed for attachment to most rifles these canister magazines have a much higher payload. They are bulkier and weigh down the weapon slightly (-1 to strike penalty). **Energy Canisters** are produced mainly for the military and are extremely difficult to acquire on the **Black Market**. They are very similar to the **CS** canisters and can be used in **Coalition Weapons**.

Typical Payload for the Energy Canister: 30 to 50 shots.

Cost: An energy canister costs 21,000 credits. Rates for recharging are high, averaging about 5500 credits.

**Note:** In the wilderness, a character may find himself at the mercy of unscrupulous businessmen who charge double to quadruple for **E-clips** and recharging.

**Costs for Conventional S.D.C. Rounds:** Available **S.D.C. rounds/bullets** include all the common types, from .22 caliber to 10 mm. Armor piercing rounds (add 1D6 **S.D.C.** to the bullet's damage) or high explosive cartridges (add 1D6×10 **S.D.C.**) are also available. A box of 48 rounds (normal bullets) typically costs about 20 to 50 credits (the higher calibers cost the most). 150 credits for armor piercing, dum-dums, and other special rounds like silver rounds. See the *Compendium of Contemporary Weapons* for a huge range of modern **S.D.C.** weapons, body armor, grenades and ammunition.



## Vibro-Blades

All **vibro-blades** are blade weapons surrounded by an invisible, high-frequency energy field that gives them mega-damage capabilities. Both **ArmaTech** and **H-Brand** manufacture these weapons, although products by the former are of a superior quality and often command 20% more than the prices listed. These weapons are popular among soldiers, **cyber-samurai**, **ronin**, **ninja**, **city rats**, **mercenaries**, **adventurers**, **smugglers** and **bandits**. Note that the **Shintoist** of the **New Empire** will not use these modern weapons —**anybody** who does is not a true believer.

### Vibro-Blades manufactured by ArmaTech & H-Brand

**Vibro-Knife, Tanto, Jitte or Sai:** 1D6 M.D. Cost: 7000 credits.

**Vibro-Bayonet:** 1D6+1 M.D., designed for attachment to a variety of rifles including the **AT-18**. Cost: 7500 credits.

**Vibro-Saber/Short Sword or Ninja Short Sword:** 2D4 M.D. Cost: 9000 credits.

**Vibro-Sword/Large One-Handed Sword (straight sword):** 2D6 M.D. Cost: 11,000credits.

**Vibro-Wakizashi (curved, samurai short sword):** 2D6 M.D. Cost: 11,000credits.

**Vibro-Katana (curved, samurai long sword):** 3D6 M.D. Cost: 15,000credits.

**Vibro-Robot Sword (giant-size for robots and large power armor):** 4D6 M.D. Cost: 25,000 credits. Note: For military use only.

### H-Brand Specials

**Note:** All the following items are made exclusively by **H-Brand** and are illegal in the Republic of Japan.

**Vibro-No-Dachi and most Large Two-Handed Swords:** 3D6 M.D. Cost: 15,000credits.

**Vibro-Kusari-Gama (sickle weapon):** 2D6 M.D. Cost: 10,000 credits. The chain and weighted end are **S.D.C.** weapons (1D6 damage) and are sometimes silver coated (useful against some monsters).

**Vibro-Yari Spear:** 2D6 M.D. Cost: 10,000 credits.

**Naginata (curved spear) or Bisento (broad blade spear):** 3D6 M.D. Cost: 15,000credits.

**Vibro-Arm Claws:** 2D6 M.D., usually three hooked blades attached to a forearm gauntlet or protective plate. Great for parrying and slashing. Cost: 11,000credits; add 2000 credits if retractable.

**Vibro-Tiger Claws/Bagh Nakh (India) and Ninja Climbing Claws:** 1D4 M.D., Cost: 5000 credits. Note: These are hand-held claws with three curved spikes used for climbing mega-damage structures or as a slashing weapon.



**Exploding Shuriken or Throwing Spike:** 4D6 S.D.C.; the high-frequency energy field is activated and deactivated by a small radio transmitter which comes standard with each three **shuriken**. Cost: 50 credits each.

**Note:** The ancient weapon proficiency skills and bonuses apply to the **vibro-blades**. Claws fall into the W.P. Knife category.

---

## Bow & Arrows

---

The bow and arrow have the advantages of not needing an artificial energy supply and being lightweight, relatively long-range, silent, and extremely accurate in skilled hands. Furthermore, the same weapon can fire S.D.C., M.D. or magical projectiles. They are especially popular among wilderness scouts, adventurers, samurai, ronin, bandits and many of the monster races. Traditionally, the long bow was one of the weapons of the elite samurai caste.

### Basic Types of Bows

Weight: Average 2 to 5 lbs (0.9 to 2.3 kg). The *modern* bow weapon is a product of high technology and is typically built out of man-made materials, lightweight (2 or 3 pounds/0.9 to 1.35kg), accurate, and is very durable.

Damage: Varies with type of weapon and arrowhead. See the **Rifts RPG**, page 32, W.P. Archery & Targeting for S.D.C. damage and effective ranges.

Rate of Fire: 2 to 8; see W.P. Archery & Targeting

Maximum Effective Range: Varies with bow type; maximum is 800 feet (244 m).

### Bow Types:

**Typical short bow:** 200 credits; 400 foot (122 m) range.

**Typical ninja bow:** 500 credits; 400 foot (122 m) range. Can be quickly disassembled and easily hidden.

**Typical long bow:** 400 to 600 credits; 700 feet (213 m) range.

**Typical samurai bow:** 600 to 900 credits. 2D6 S.D.C. damage per arrow, 800 foot (244 m) range.

**Typical modern composite bow:** 500 to 1200 credits; 500 to 700 foot (152 to 213 m) range.

**Typical traditional crossbow:** 400 to 600 credits; 600 foot (183 m) range.

**Typical crossbow pistol:** 200 credits, 1D4 S.D.C. damage; 120 foot (36.6 m) range.

**Typical modern crossbow:** 600 to 1200 credits; 700 foot (213 m) range.

### High-tech Arrowheads

All types listed are suitable for either crossbow or conventional bow and arrows.

**Conventional arrowheads:** Short Bow: 2D4 S.D.C., Long Bow, Modern Composite or Large Crossbow: 2D6 S.D.C. per arrow.

**Light Explosive:** 1D6×10 S.D.C.; costs 100 credits each.

**Medium Explosive:** 1D6 M.D.C.; costs 300 credits each.

**Heavy Explosive:** 2D6 M.D.C.; costs 550 credits each.

**High Explosive:** 3D6 M.D.C.; costs 900 credits each.

**Gas:** Arrowhead shatters on impact, releasing a toxic gas that fills a ten foot area (3.0 m). Tear gas costs 100 credits, **tranquilizer** gas (**sleep/knockout** for 1D6 minutes) costs 250 credits, paralysis gas (a nerve toxin, causing temporary paralysis for 1D6 minutes) costs 400 credits each. Everybody in the gaseous area must roll to save versus harmful drugs (15 or higher).

**Smoke:** No damage; creates a smoke screen covering a 20 foot (6.1 m) area. Cost: 60 credits each; come in four colors, yellow, red, grey and black.

**Flare:** Emits a bright, sparkling light; burns for 60 seconds. Cost: 10 credits each.

**Neural Disrupter:** Works like a one-shot neural mace. Cost: 400 credits each; rechargeable and reusable 1D6 times before breaking. Inflicts no other damage.

**Tracer Bug:** Transmits a radio signal that can be followed up to 8 miles (12.8 km) away. Battery powered, with a limited life of 72 hours of constant transmission. Arrow must stick into the target or fall on top of the object (without falling off). There is always a chance that the tracer bug arrow will become dislodged and fall off (roll once for every half hour; 1-32% chance). Cost: 200 credits each. Inflicts normal S.D.C. damage.

**Magic:** The availability and cost of magic or **techno-wizard** bow and arrows varies dramatically. Most common in the New Empire. Cost: 800 to 8,000 credits.

---

## Traditional Japanese S.D.C. Weapons

---

A variety of conventional, S.D.C. weapons are manufactured by H-Brand, the New Empire, many of the independent kingdoms, and organizations and warrior families like the samurai and ninja. The following are some of the most common or interesting weapons and items.



**Aikuchi/Tanto:** Curved Japanese daggers which can be thrown. The **Tanto** has a hilt, the Aikuchi does not. Cost: 100 to 500 credits; varies according to the weapon's quality and beauty. Damage: 1D6 S.D.C. W.P. Category: Knife.

**Bisento:** A large spear with a broad, curved blade, considered to be a kind of pole arm. Cost: 500 credits. Damage: 3D6 S.D.C., W.P. Category: **Polearm** (page 155, **Triax and the NGR**).

**Blow Gun:** Essentially a small pipe through which darts are fired by air pressure. A favorite weapon of the ninja despite its short range of 50 feet (15.2 m). Cost: 30 credits. Damage: None; the dart causes no damage but is often coated with poison or drugs. W.P. Category: Archery & Targeting.

**Bokken:** A wooden version of the samurai's katana, often used in practice or competition. It is still a deadly weapon in the right hands, which will be more than capable of taking down an armed opponent. The Bokken is a popular weapon in The Zone for use against vampires and their ilk. Cost: 80 credits. Damage: 2D4 S.D.C. W.P. Category: Sword.

**Daisho:** The word **Daisho** literally means, "the long and the short," and refers specifically to the pair of swords known as the **Katana** and **Wakizashi**. The **wakizashi** is the long killing sword, up to 3 feet (0.9 m) in length. The katana is a short sword (Westerners might consider it a long knife), and is frequently used with the larger blade, one in each hand, as paired weapons.

The Daisho is the symbol of the samurai caste; only samurai can carry them. "True" Daisho or Samurai swords are treated with reverence for, according to ancient beliefs, each "True" Samurai sword possesses a soul and is a living thing. See the True Samurai O.C.C. for details about these special, minor rune weapons.

Most of the people of the New Empire follow the ancient ways, so only samurai carry the Daisho, however, meres, adventurers and "**techno-lovers**" (just about everybody else) do not give the weapons or

WAKIZASHI  
SHORT SWORD

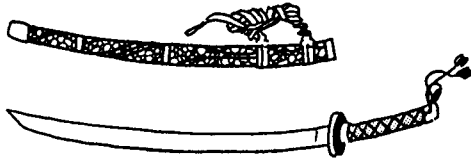

KATANA  
LONG SWORD

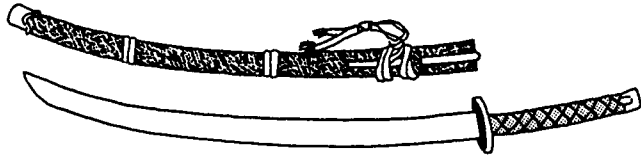

the samurai caste the reverence they deserve and may use a Daisho, katana or wakizashi separately. H-Brand and many non-traditional arms dealers make and sell ordinary swords in the shape and size of the traditional swords. After all, the curved Katana and Wakizashi have become symbols of Japan and samurai even among the technocrats, however, they are ordinary weapons without any special or magical abilities (a True Samurai can detect this the moment he examines the weapon).

Cost: Manufactured versions sell for 900 to 1200 credits for the Katana and 400 to 600 credits for the Wakizashi. Damage: Katana: 3D6; Wakizashi: 2D6 S.D.C. W.P. Category: Sword. Note: Authentic samurai swords are considered priceless, inflict mega-damage, and are usually passed on from generation to generation of samurai. They are occasionally available for sale when a True Samurai is slain and his weapons are taken by his slayer. The cost of these lesser rune swords is typically 1D4 million credits!

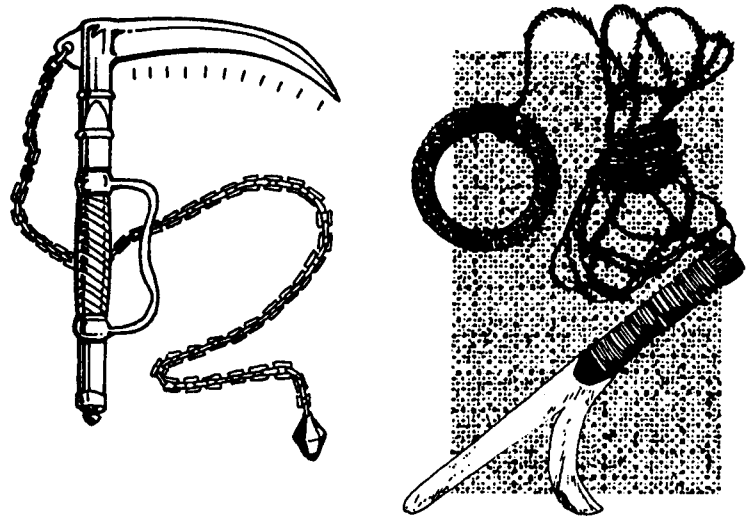

tial arts, assassin or Ninjitsu. All others are -2 to strike and parry and each attack counts as two melee actions.

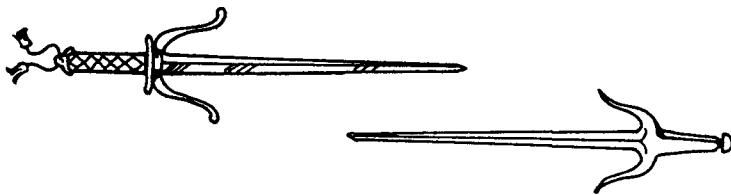

**Jitte or Sai:** These weapons look like oversized, three-pronged forks and are generally designed to be used as a pair, one in each hand. Both weapons are modified farming tools originally designed by the ninja to counter the samurai sword (parry and pin swords). Even in the Japan of Rifts Earth, they are easier to acquire than a sword or spear, especially in the feudal society of the New Empire where peasants are forbidden to have weapons. A skilled user can entangle an opponent with one hand and attack with the sai in the other (requires paired combat skill). Cost: 100 credits per pair. Damage: 1D6 S.D.C. W.P. Category: Knife.

**Katana:** A mass market version of the samurai sword, predominantly sold by H-Brand. Cost: 450 credits. Damage: 3D6 S.D.C. W.P. Category: Sword.

**Kusari-Fundo:** A larger, more deadly version of the Manriki-Gusari. The chain is heavier and from 2 1/2 feet to 4 feet (0.75 to 1.2 m) long. Cost: 120 credits. Damage: 2D6 S.D.C. W.P. Category: Chain. Note: This weapon can be used only by those trained in hand to hand martial arts, assassin, Ninjitsu or W.P. Chain. All others are -2 to strike and parry and each attack counts as two melee actions.

**Kusari-Gama/Kyoketsu-Shogi:** Another ninja favorite is the combination of a chain with a weight on one end and a sickle weapon on the other. The Kyoketsu-Shogi is a similar weapon but is made with rope attached to an iron ring on one end and a double blade on the other. Both weapons can be used to entangle with one end while the other can still be used for striking. All the components of the weapons are easily acquired by non-samurai, making it easy to make or purchase in the New Empire. Cost: The Kyoketsu-Shogi costs 200 credits, the Kusari-Gama costs 500 credits. Damage: Kyoketsu-Shogi: 1D8 or 2D4 S.D.C.; Kusari-Gama: 1D10 or 2D4+2 S.D.C. W.P. Category: Chain. Note: These weapons can be used only by those trained in hand to hand mar-

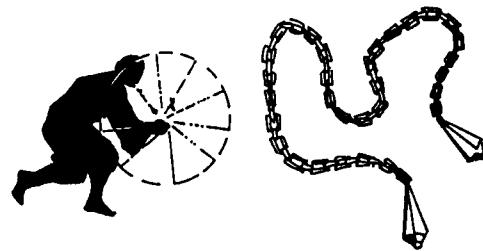

**Manriki-Gusari:** A chain weapon with solid, blunt weights on each end. It is used in the same style as a Kusari-Gama, entangling with one end, striking with the other. The weapon is also easy to disassemble and conceal. The materials to make a Manriki-Gusari are readily available and as a result this weapon can be easily found in the New Empire. Cost: 30 credits. Damage: 1D8 or 2D4 S.D.C. W.P. Category: Chain. Note: This weapon can be used only by those trained in hand to hand martial arts, assassin, Ninjitsu or W.P. Chain. All others are -2 to strike and parry and each attack counts as two melee actions.

**Naginata/Yari:** Long spears; difficult to conceal. The difference between the two is that the Naginata blade is curved while the Yari is straight. Cost: 300 credits. Damage: 2D4 S.D.C. W.P. Category: Spear.

**Ninja-to/Ninja Short Sword:** A short sword similar to the Wakizashi but with a straighter blade, used by the Ninja. Because of its small size the weapon is easier to conceal. Cost: 500 credits. Damage: 2D4 S.D.C. W.P. Category: Sword.

**No-Dachi:** A huge, curved, two-handed sword, 5 to 6 feet (1.5 to 1.8 m) long. Typically the weapon is pulled from a scabbard slung over the back or shoulder. Cost: 600 credits. Damage: 3D6 S.D.C. W.P. Category: Sword.

**Nunchaku:** These weapons consist of two lengths of wood or iron connected by a short chain. Originally an agricultural flail, the Nunchaku have been adopted for martial arts use as paired weapons for striking. One of the main advantages of Nunchaku is for entangling. This can only be done if one weapon is used with two hands. Cost: 50 credits. Damage: 1D8 or 2D4 S.D.C. W.P. Category: Chain. Note: This weapon can be used only by those trained in hand to hand martial arts, assassin, Ninjitsu or W.P. Chain. All others are -2 to strike and parry and each attack counts as two melee actions.

**Shinobi-Zue:** A hollow wooden staff which contains a weighted length of chain. Cost: 250 credits. Damage: 1D10 or 2D4+2 S.D.C. W.P. Category: Staff.

**Shikomi-Zue:** This is a staff with a concealed blade which is spring loaded and released by a trigger stud that is pressed or turned. The weapon is a favorite of Ninja who often disguise themselves as blind men. The Shikomi-Zue can be used as a somewhat fragile (S.D.C. 50)

Bo Staff or a spear. Cost: 200 credits. Damage: 1D8 S.D.C. W.P. Category: Staff or Spear.

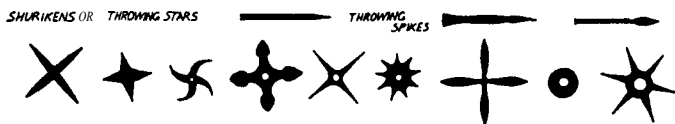

**Shuriken:** The famous "throwing stars" of the ninja designed for concealment and to distract the enemy (when thrown) rather than for deadly effect. To discourage pursuit, the ninja often threw these weapons, covering their retreat. Shurikens are often covered with poison or drugs. Any of the chemicals/toxins/poisons described in the various **Rifts** titles may be applicable if approved by the G.M. Cost: 10 credits each. Damage: 1D4 S.D.C. W.P. Category: Archery & Targeting.

**Tonfa:** A short wood weapon ideal for parrying and close combat. It is similar in appearance to the nightstick. Cost: 50 credits. Damage: 1D6 S.D.C. W.P. Category: Blunt.

**Wakizashi:** A mass market version of the Samurai short sword, predominately sold by H-Brand. Cost: 300 credits. Damage: 2D4 S.D.C., W.P. Category: Sword.

## AT-N20 Neural Stick

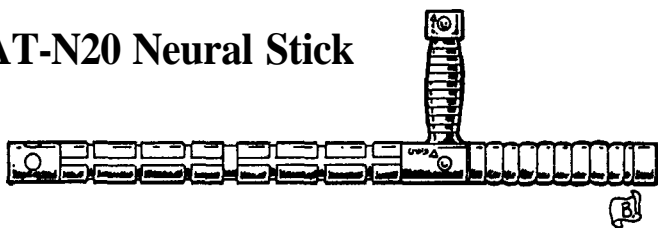

ArmaTech has created a blunt, club or mace-like weapon used by the police for close combat and riot control. This stun weapon resembles the classic "nightstick" of pre-Rifts days and is used to subdue criminals and troublemakers without having to use deadly force. The Neural Stick delivers an electric charge that temporarily short-circuits the nervous system when it strikes. There is a chance of rendering an unarmored person unconscious, but most victims remain conscious, with impaired movement.

Physical Damage: 1D6 S.D.C. plus P.S. attribute bonus (if any) when used as a clubbing weapon. The stick is a mega-damage structure (17 M.D.C.), making it suitable for parrying S.D.C. and M.D. weapons like **vibro-blades**.

Stun Damage: Victims struck by the neural stick must roll to save vs non-lethal poison/attack and need a 16 or higher to save. A successful save means the victim loses one melee action from the jolt but is otherwise unimpaired. A failed roll to save means the character is stunned: -7 on initiative, -5 to strike, **parry**, and **dodge**, and reduce melee actions/attacks, speed and skill performance by half. The character must save each time he or she is struck.

Stun Duration: 2D4 melee rounds. The duration and penalties are increased by 2D4 melee rounds for every hit by the stick. There is also a cumulative chance of 15% per each subsequent hit that the character will be rendered unconscious for 1D4 minutes. This means the second hit has a 15% chance of knocking the victim out, the third hit 30%, fourth hit 45%, and so on.

Limitations: The stick is ineffective against environmental M.D.C. body armor, power armor, and full conversion borgs, but is effective against Dog Pack armor and half suits, or body armor without a helmet (not fully environmental without the helmet attached).

Partially reconstructed borgs, juicers and crazies are all +2 to save and the stun effect lasts half as long.

No effect against robots, androids, and most supernatural beings and creatures of magic.

## AT-AAD Anti-Armor Dissolver Missile or Grenade

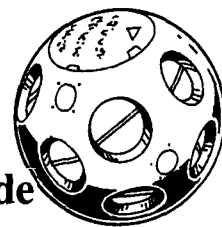

Upon impact, the grenade or missile releases a cloud of tiny particles. These particles are actually thousands of tiny **nano-bots** that attack mega-damage armor on a molecular level; usually starting from the point of impact. It is most effective against M.D.C. body armor, power armor and thin plates of metal.

The AADs are programmed to only attack the primary target, e.g. the first armor they find/strike. They do not "leap" from one armored mega-damage structure to another like fleas on a dog, or move from one target to the next like a swarm of ants. Furthermore, they are programmed to seek out and attack only military-type metal alloys like those used for power armor, body armor, cyborgs, robots, guns and armored vehicles. They will NOT attack M.D. ceramics, plastics, concrete, or superhuman flesh (or magic items/materials). Nor will they attack mega-damage materials coated, encased or attached to real or artificial flesh; protecting most cybernetic and bionic implants, optics, organs, and limbs. However, borg armor and external weapons, guns and plating are vulnerable and subject to dissolving.

As an additional fail-safe, the nano-bots only have a life of 50 minutes, after which time they become inert and harmless.

Primary Purpose: **Anti-Armor/Defense**.

Weight: The average grenade weighs one pound (0.45 kg); the average mini-missile: 8lbs (3.6 kg).

Mega-Damage: Special. The nano-bots attack and reduce the physical integrity of body armor and thin plating, reducing the overall M.D.C. of most body armor and light power armor by **half!**

Heavy power armor and light vehicles will see their M.D.C. reduced by 30%, while heavy, thick armor like those used in giant robots and tanks are reduced by 10%. This overall reduction of M.D.C. occurs within one minute (four melee rounds) of exposure to the armor dissolving nano-bots. Its effects are noticeable as a fading of the color of the material or dull blotches. Many of the more sophisticated environmental computer monitoring systems of such suits and vehicles will indicate structural weakness or damage.

Additional effects and damage on the armor takes longer (1D4×10 minutes) but can be devastating as the **nano-assailants** focus on one specific area of its victim and completely dissolve it. Roll percentile or pick one:

**01-20 Main weapon.** This will always be the most powerful and/or important weapon of the armor, **bot**, borg or vehicle and can include hand-held weapons.

**21-40 External Sensor array.** On bots, cyborgs, and body or power armor, this is likely to include the destruction of radar/sonar, targeting and communications.

**41-60 A specific appendage.** On human-shaped bots and armor, this will be one of the legs, arms or **thrusters**. Plating on that part of the armor will completely dissolve and disappear. This also breaches the environmental protection of the armor, exposing the pilot to external atmosphere and conditions, as well as leaving the **appendage/limb** completely exposed to attack. Of course, any special features, weapons, or abilities built into that limb are also destroyed.

On an M.D.C. vehicle, this will mean one of its legs, wheels, treads, or thrusters are destroyed. In the alternative, a weapon turret, cannon or sensor/communications array can be destroyed.

On an armored **bunker/building**, this will mean either a weapon turret, cannon, communications tower or sensor array.

**61-80 Head or Hatch.** On human-shaped armor, the helmet is attacked and dissolved, leaving the head exposed to potential attack and damage (-3 for attackers to strike and requires a "called shot"), as well as exposing the pilot to external atmosphere and conditions (toxic gas, pollution, heat, radiation, etc.).

If a vehicle, building or giant robot, the AAD attack can dissolve one entire hatch/door, offering attackers a way inside.

**81-00 Two secondary weapon systems.** On power armor or bots, this might include **vibro-blades**, forearm lasers, chest guns, etc. On a vehicle or bunker it may include small or secondary turrets, light energy weapons, short-range or mini-missile launchers, and manned weapon turrets.

Rate of Fire: Varies with weapon type; usually fired one at a time or in small volleys of three mini-missiles. Not available in large missiles.

Maximum Effective Range: Hand grenades can be thrown about 100 feet (30.5 m), rifle launched grenades/rockets about 300 feet (91.5 m) and mini-missiles one mile (1.6 km), although the latter is usually launched at the comparatively close-range of 3000 feet (910 m) to insure a strike.

Payload: One AAD package per missile or grenade. Elite Republic soldiers, like the Japanese SAMAS troops, may have a maximum of six or as few as one grenade or missile.

Delivery System: **Nano-bots** are typically contained in a hand grenade, rifle grenade/rocket, or mini-missile.

Note: AAD **nano-technology** is ONLY available in the Republic of Japan and even then only to authorized military defense units.

G.M. Note: The AAD is a carefully guarded military secret and should rarely be available to player characters. For that matter, only elite military troops and special government agents will have access to it, so they are not available even to most non-player characters and villains.

The AAD is NOT available on the Black Market or in any other part of the world. Nano-technology, like the SAMAS and many other pre-Rifts technologies and secrets, exists only in the Republic of Japan and the city of Nagasaki in particular. The Black Market, Coalition States and most nations do NOT have the technology, resources or understanding to "knock-off any sort of nano-technology. Only Triax or Naruni Enterprises could learn and develop nano-tech, but it will take even them 10 to 15 years of study and development to reach a stage equal to that currently held by the Republic of Japan. Also remember that the people of Japan are isolated from the rest of the world and like it that way — most other nations have no idea that they even exist.

## AT-23 Plasma Thrower

The average flame-thrower unit had become an obsolete weapon with the advancement of modern arms. With the appearance of supernatural menaces vulnerable to fire, the flame-thrower has again become a useful tool. **ArmaTech** has produced a modernized version of the weapon that shoots short plasma streams in stead of flaming napalm.

Weight: 15 lbs. (7 kg)

Mega-Damage: 1D4x10 M.D. per spray

Rate of Fire: Aimed shots only

Maximum Effective Range: 200 feet (61.0 m)

Payload: 8 sprays per plasma canister.

Cost: 20,000 credits.

Note: No availability in the Republic of Japan (limited to the military), but **H-Brand** makes a knock-off version with poor availability in other parts of Japan.

# Energy Pistols

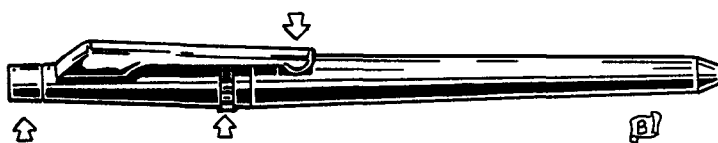

## AT-6 "Mini" Laser Pistol

The ArmaTech AT-6 is a new development for military service. Nicknamed the "Escape Artist," it is a small pistol that fits easily in the closed palm of a hand. Designed for concealment (+10% to palming and concealment skill rolls), it is made in two shapes, one looks like a cigarette lighter, the other a pen flashlight. It is intended to allow a captured soldier to remain armed and effect an escape, as well as for use in espionage and as a tool. Even with the high security of ArmaTech Industries, a handful of these weapons have found their way to the street. An AT-6 is an extremely valuable commodity on the Black Market and fetches a high price.

Weight: 1 lb. (0.45 kg)

Mega-Damage: 1D6 M.D.

Rate of Fire: Standard

Maximum Effective Range: 300 feet (91.4 m)

Payload: 6 blasts; requires a special **E-clip**.

Market Cost: 30,000 credits; 50,000 credits on the Black Market, 5,000 credits per mini-**E-clip**.

Note: Available only to the military. Rarely available on the Black Market and H-Brand doesn't even know it exists yet, so there are no knock-offs available.

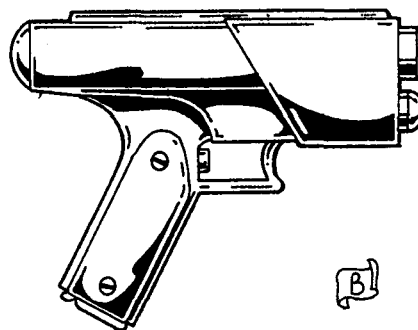

## AT-8 Laser Pistol

One of the few mass market mega-damage weapons allowed to be sold to the civilian population. It can be used for personal protection (especially against supernatural beings, mutants and corporate ninja), home defense, target shooting and even hunting. In the turbulent, monster ridden world of Rifts Earth, many an executive takes (foolhardy) comfort in having a light mega-damage **sidearm** at his disposal. However, *all* AT-8's must be registered and their sale is limited to corporate security forces, security/guard companies, high ranking corporate executives, and those living or working beyond the safety of the big cities, as well as select individuals highly placed in the government or high finance (as is frequently the case, the rich have access to things not ordinarily available to the average person). Of course, some AT-8's and H-Brand knock-offs have made their way into the criminal underworld and are available illegally to crooks and citizens alike. Consequently, the AT-8 is found on the sparkling floors of corporate Japan to the back alleys of the Republic.

The AT-8 laser pistol is light, reliable and offers a good damage capacity, although its low payload and limited stopping power has made it unacceptable for police and military use.

Weight: 3 lbs (1.4 kg)  
Mega-Damage: 1D6 M.D.  
Rate of Fire: Standard  
Maximum Effective Range: 500 feet (152 m)  
Payload: 8 shots.  
Market Cost: 10,000 credits; 8500 credits on the Black Market.

Note: Good availability in and out of the Republic. **H-Brand** makes a knock-off called the "H-8" and a "Super H-8." The former is identical to the AT-8 and sells for 8000 credits. The "Super" is fundamentally the same but has a 12 shot **E-clip**, an 800 foot (224 m) range and sells for 11,000 credits.

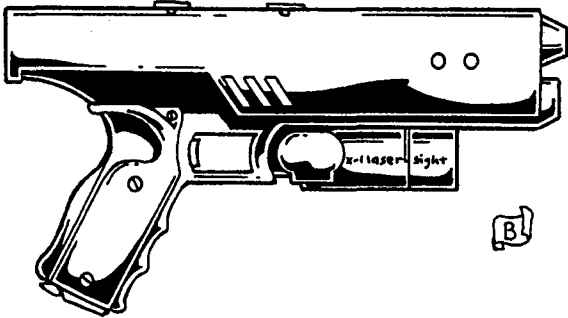

## AT-20 "Sharpshot" Police Special Laser Pistol

A heavy laser pistol with greater stopping power, a larger payload, telescopic sight mounts and laser targeting. It is also extremely accurate at long-range.

Weight: 2 lbs (0.9 kg)  
Mega-Damage: 2D6 M.D.  
Rate of Fire: Aimed shots and short bursts (4 blasts) only.  
Maximum Effective Range: 1000 feet (305 m)  
Payload: 20 shots.  
Bonus: +1 to strike on an aimed shot.  
Market Cost: 15,000 credits; 22,000 on the Black Market.

Note: Available only to the military, police agencies and authorized corporate security forces. H-Brand has a knock-off called the H-20 Sniper Pistol that costs 17,000 credits; poor availability inside the Republic, fair to good outside.

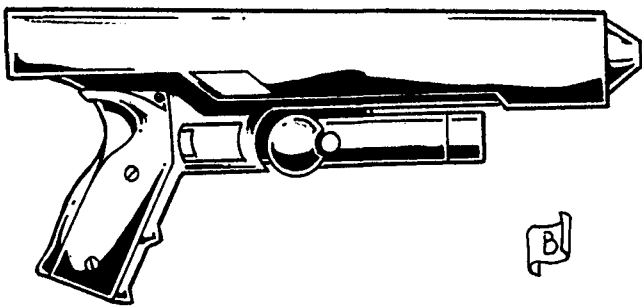

## AT-30 Combat Laser Pistol

The AT-30 is the official military **sidearm** of the Republic Armed Forces. The weapon is sleeker in overall design and has a longer barrel which has greatly improved accuracy. It comes standard issue with a pair of extra **E-clips**, telescopic sight mounts and a laser targeting mechanism.

Weight: 2.5 lbs. (1.2 kg)  
Mega-Damage: 2D6+2 M.D.  
Rate of Fire: Standard

Maximum Effective Range: 1000 feet (305 m)  
Payload: 30 shot clip.  
Bonus to Strike: +1 bonus to aimed shot due to the laser targeting and superior balance of the pistol.  
Market Cost: 22,000 credits; 30,000 credits on the Black Market but is rarely available. The H-30 knock-off costs 35,000 credits.

Note: Available only to the military and elite members of police agencies. H-Brand has a knock-off called the H-30 Siege Pistol; poor availability inside the Republic, fair outside.

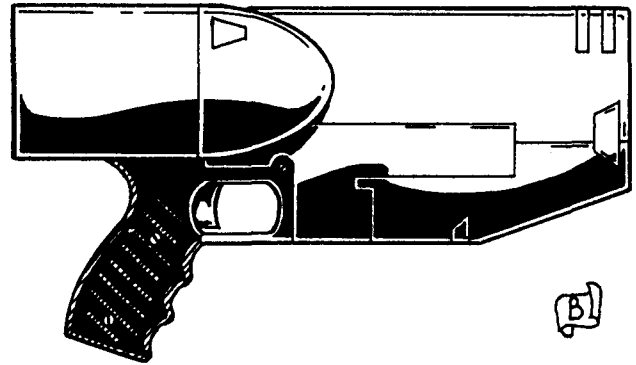

## AT-130 Particle Beam Pistol

Particle beam technology has always been one of **ArmaTech's** areas of specialty. The **P-beam** pistol is a **pre-Rifts** design and is the only particle beam *pistol* of human design on Earth. The AT-130 is exclusive to high ranking officers and espionage agents in the military. It comes standard issue with a pair of extra E-clips, telescopic sight mounts and a laser targeting mechanism.

Weight: 4 lbs. (1.8 kg)  
Mega-Damage: 5D6+6 M.D. per single blast!  
Rate of Fire: Standard; single shot only.  
Maximum Effective Range: 600 feet (183 m)  
Payload: 10 shots per E-clip  
Bonus: +1 to strike on an aimed shot.  
Market Cost: 30,000 credits; limited military availability.

Note: Available only to the Republic of Japan's military. Rarely available on the Black Market and when it is, it costs a staggering 90,000+ credits. H-Brand doesn't even know it exists, but even if they did, they cannot duplicate P-beam technology so there are no knock-offs.

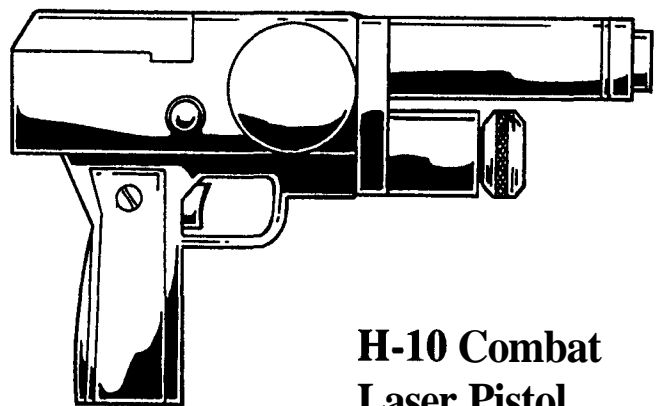

## H-10 Combat Laser Pistol

The **H-10** is a super-cheap, but large, archaic laser pistol sold by the H-Brand Company. The pistol has only 23 M.D.C. and uses a standard E-clip, but is heavy and has light stopping power. These weapons are common among **adventurers**, bandits and thugs.

Weight: 4.5 lbs (2 kg)  
Mega-Damage: 2D4 M.D.  
Rate of Fire: Standard  
Maximum Effective Range: 600 feet (183 m)  
Payload: 30 blasts!  
Market Cost: 12,000 credits, good availability.

---

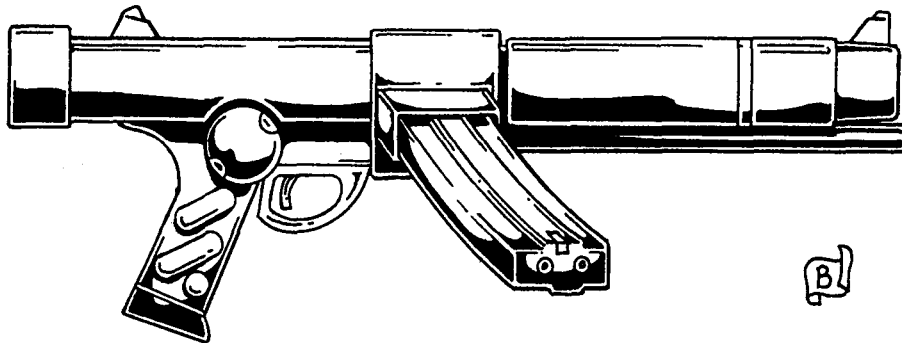

### H-13 Ion Pulse Pistol

Another heavy H-Brand pistol made with mercenaries and Special Forces in mind. It was turned down for military use by most kingdoms, but has since become a popular weapon among adventurers. The H-13 resembles a pre-Rifts sub-machinegun.

Weight: 5 lbs. (2.25 kg)

Mega-Damage: 2D6 M.D. single shot, or 6D6 M.D. per multiple pulse burst (three nearly simultaneous shots).

Rate of Fire: Standard.

Maximum Effective Range: 800 feet (244 m)

Payload: 20 shots

Market Cost: 22,000 credits, poor availability in the Republic, good availability elsewhere.

---

## Energy Rifles & Rail Guns

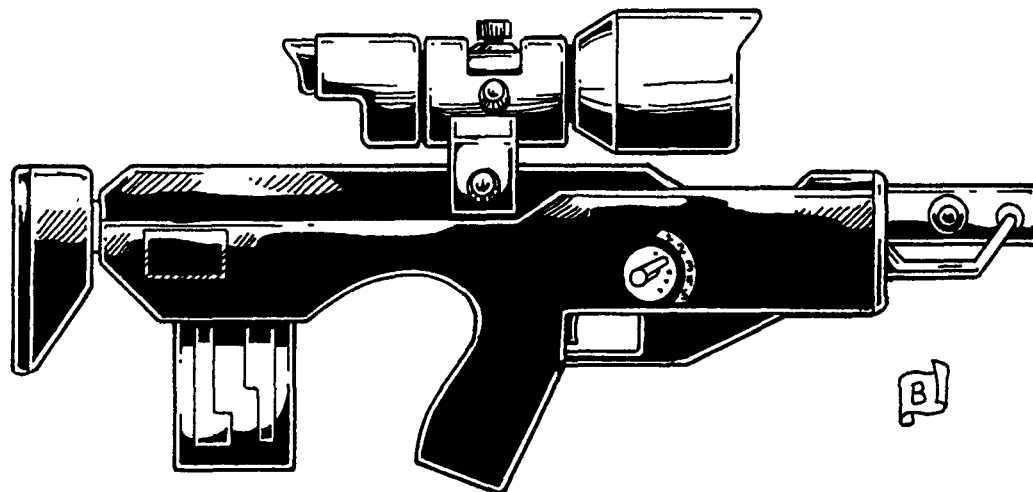

### AT-23 Police Stun Rifle

The AT-23 stun rifle is standard issue for the police in the Republic of Japan. In fact, it was specifically designed for the police force in dealing with human criminals, riot control, and augmented humans. The stun rifle, like the neural stick, offers the police a non-lethal alternative to subduing lawbreakers. The rifle fires an electrical charge that temporarily short-circuits the nervous system when it strikes. There is a chance of rendering an **unarmored** person unconscious, but most victims remain conscious, with impaired movement.

The stun rifle does inflict some measure of physical damage, but far less than conventional weapons. It also has five settings so that it can be appropriately adjusted for the best response to the needs of the situation. For example, the lowest stun setting can be used on children, the second on the elderly and young teenagers, the third on adults, while the highest are reserved for juicers, crazies, mutants and supernatural creatures.

The weapon comes standard with a telescopic, passive nightvision scope and laser targeting.

**Weight:** 8 lbs (3.6 kg)

**Physical Damage:**

**Setting One:** 1D6 S.D.C.; can be used against children, pregnant women, and the very **weak/injured/elderly**.

**Setting Two:** 2D6 S.D.C.; can be used against the elderly, young teenagers, adults in poor to average physical condition, and small to medium sized animals like dogs and monkeys.

**Setting Three:** 3D6 S.D.C.; suggested for use against adults in good to excellent physical condition.

**Setting Four:** 6D6 S.D.C.; suggested for use against adults in superior physical condition, those high on the effects of drugs, juicers, crazies, partially reconstructed **borgs**, mutants, and non-humans as well as large animals like horses, cattle, wolves, tigers, etc.

**Setting Five (Maximum Level):** 1D6 M.D.; used only against juicers, crazies, partially reconstructed borgs, full conversion borgs, monsters, and non-humans.

**Stun Damage:** At the *correct* setting, most victims shot by the stun rifle will suffer the same type of damage and effects. In all cases, the character must roll to save vs non-lethal **poison/attack** and needs a 16 or higher to save (children and small animals need an 18 or higher to save). A successful save means the victim loses one melee action from the jolt and takes damage, but is otherwise unimpaired.

A failed roll to save means the character is stunned: -9 on initiative, -7 to strike, parry, and dodge, and reduce speed, melee actions/attacks, and skill performance by half. The character must save each time he or she is struck.

**Stun Duration:** 2D4 melee rounds. The duration and penalties are increased, 2D4 melee rounds for every blast that hits. There is also a cumulative chance of 15% that each subsequent stun blast will render the character unconscious for 1D4 minutes. This means the sec-

ond hit has a 15% chance of knocking the victim out, the third hit 30%, forth hit 45%, and so on.

**Limitations:** If the setting is too low, the stun blast will have no or little effect. Characters are +4 to save for each level the blast is too low. For example, an adult in excellent physical condition shot at setting one is +8 to save while a Juicer shot at setting one would be +16 to save! If the setting is too high, the character suffers greater, potentially lethal, damage and is +15% more likely to lose consciousness. Obviously an M.D. blast will atomize an S.D.C. character. The police use this weapon very judiciously and with extreme caution.

The weapon is ineffective against environmental M.D.C. body armor, power armor, and full conversion borgs, but is effective against Dog Pack armor and half suits, or body armor without a helmet (not fully environmental without the helmet attached).

Partially reconstructed borgs, juicers and crazies are only vulnerable to settings 4 and 5, but even then are +1 to save.

Full conversion borgs can be affected at the maximum setting of five, but are +4 to save, and the penalties and duration are half.

No effect against robots, androids, vampires, and the most powerful supernatural beings and creatures of magic. However, lesser demons and young supernatural beings can be effected by setting number five, but are +3 to save.

**Rate of Fire:** Single shot; semi-automatic, best for aimed shots.

**Maximum Effective Range:** 800 feet (224 m).

**Payload:** 20 shots per standard **E-clip**.

**Cost:** 25,000 credits; 35,000 on the Black Market (fairly rare).

**Note:** Available only to the police and military (used by Military Police and Special Forces). There is no **H-Brand** copy simply because the manufacturer doesn't see a big market for the item.

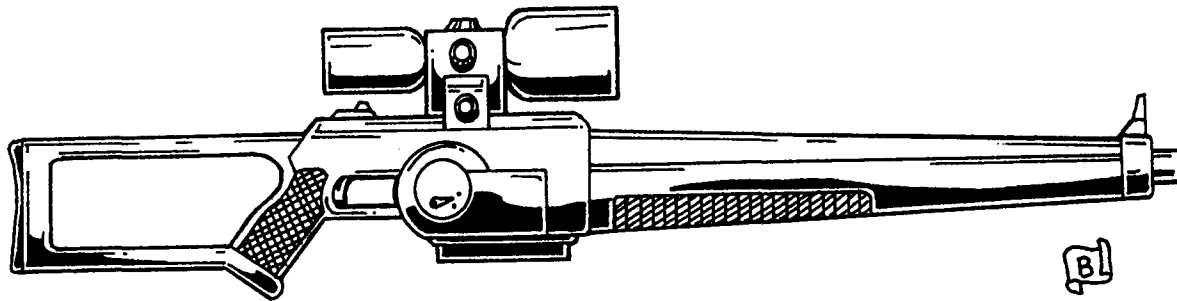

## AT-84 "Sharpshot" Laser Rifle

The AT-84 is a sleek, accurate and lightweight rifle used by the police, military and security/guard agencies. It is occasionally sold to highly placed corporate leaders and those who have dealings outside the protection of the cities. The sale and use of all AT-84's must be authorized by the government and registered with the police and military. This weapon has also become a favorite of assassins and snipers.

**Weight:** 6 lbs (2.7 kg)

**Mega-Damage:** Two settings: light, inflicting 2D6 M.D. or heavy, inflicting 4D6 M.D.

**Rate of Fire:** Standard

**Maximum Effective Range:** 3000 feet (914 m)

**Payload:** 30 light shots; each heavy blast counts as two light.

**Bonus:** +1 to strike on an aimed shot.

**Market Cost:** 20,000 credits; 34,000 on the Black Market.

**Note:** Available only to the military, police agencies and authorized corporate security forces. H-Brand has a knock-off called the H-84 Sniper Rifle that costs 29,000 credits, but range is limited to 2000 feet (610 m) and one setting at 3D6 M.D.; poor availability inside the Republic, fair to good outside of it.



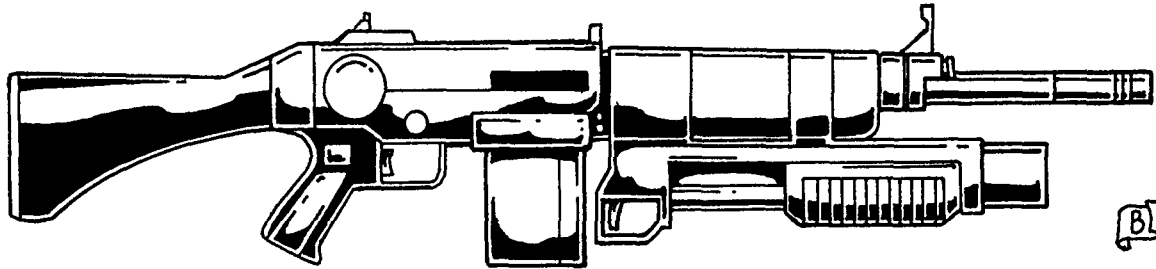

B1

## AT-88 Combat Laser Rifle

The AT-88 is the standard issue rifle of the Republic Armed Forces. The rifle is very accurate, has good range, good stopping power and the addition of an underbarrel, pump action grenade launcher.

Weight: 9 lbs. (4.1 kg)

Mega-Damage: Laser: 3D6 M.D.

Grenade: 4D6 M.D. fragmentation, 5D6 HE/AP, smoke, or AAD-Dissolver.

Rate of Fire: Standard

Maximum Effective Range: 3000 feet (914 m)

Payload: Laser: 30 shots per E-clip or 100 shots per E-canister.

Grenade: Three, but can be reloaded by hand at the cost of one melee action per grenade loaded.

Market Cost: 30,000 credits; 54,000 on the Black Market (rare).

Note: Available only to the military and elite police teams (anti-monster and anti-terrorist). There is no H-Brand copy.

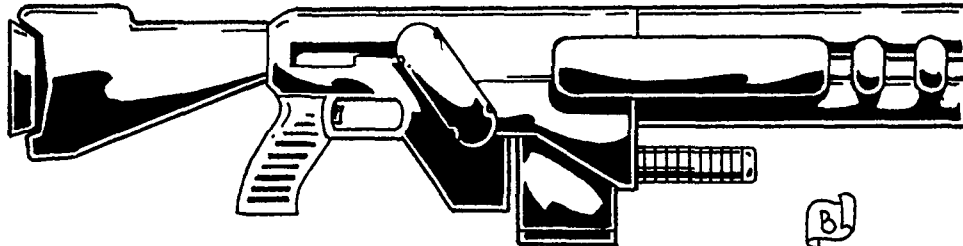

B1

## AT-230 Particle Beam Rifle

The AT-230 P-beam rifle has incredible stopping power in a durable, compact frame. The weapon is issued to elite power armor troops, SAMAS, elite borgs, Special Forces and other special operatives. It is one of the most powerful rifles on Earth.

Weight: 11 lbs (5 kg)

Mega-Damage: 1D4×10+10M.D. per single blast.

Rate of Fire: Standard; semi-automatic.

Maximum Effective Range: 1300 feet (395 m)

Payload: 10 shots per standard E-clip, 50 shots from an energy canister.

Market Cost: 45,000 credits; limited military availability.

Note: Available only to the military of the Republic of Japan. Rarely available on the Black Market and when it is, it costs a staggering 150,000+ credits. H-Brand knows it exists, but they cannot duplicate P-beam technology so there are no copies.

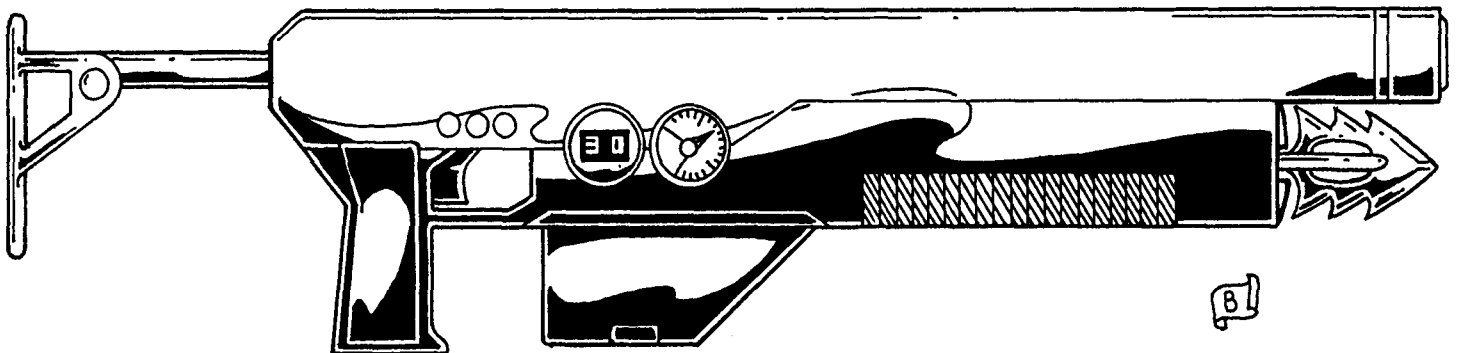

B1

## ATU-80 Underwater Assault Rifle

The standard weapon of the Republic's tiny navy, the ATU-80 is suitable for use both on dry land and underwater. ArmaTech has produced a combination weapon that combines a laser rifle with a vibrospear/harpoon launcher. In addition to the blue laser, the rifle has a

single spear launcher that can fire a conventional S.D.C. spear or a vibro-spear.

Weight: 8 lbs (3.6 kg)

Mega-Damage: Three settings for the laser, 6D6 S.D.C., 2D6 M.D. or 4D6 M.D. per shot. The latter drains the payload as if two blasts

were fired. The **vibro-spear** does 1D6 M.D., while the conventional spear inflicts 2D6 S.D.C.

Rate of Fire: Standard

Maximum Effective Range: The laser has a maximum range of 2000 feet (610 m) underwater or in the air; 400 feet (122 m) for spears.

Payload: 30 shots per standard **E-clip** or 100 shots per energy canister (heavy 4D6 M.D. blasts count as two blasts). Spear launcher: One shot; takes one melee **attack/action** to reload.

Market Cost: 25,000 credits; 30,000 on the Black Market.

Note: Available only to the military, police agencies and authorized corporate security forces. There is no **H-Brand** version because market demand is minimal.

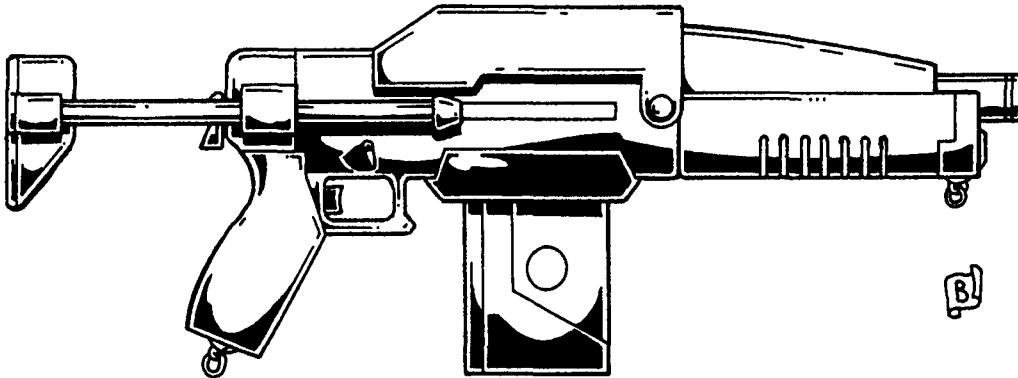

## H-12 "Defender" Ion Pulse Rifle

The H-12 ion pulse rifle can fire a single blast or three simultaneous shots in a damaging pulse. The weapon is popular with adventurers, bandits and mercenaries.

Weight: 9 lbs (4.1 kg)

Mega-Damage: 2D6 M.D. single shot, 6D6 M.D. per multiple pulse burst (three simultaneous shots).

Rate of Fire: Standard

Maximum Effective Range: 1600 feet (488 m)

Payload: 30 shots per standard E-clip.

Market Cost: 26,000 credits, good availability.

Note: Illegal in the Republic of Japan, but can be found on the streets, especially among criminals.

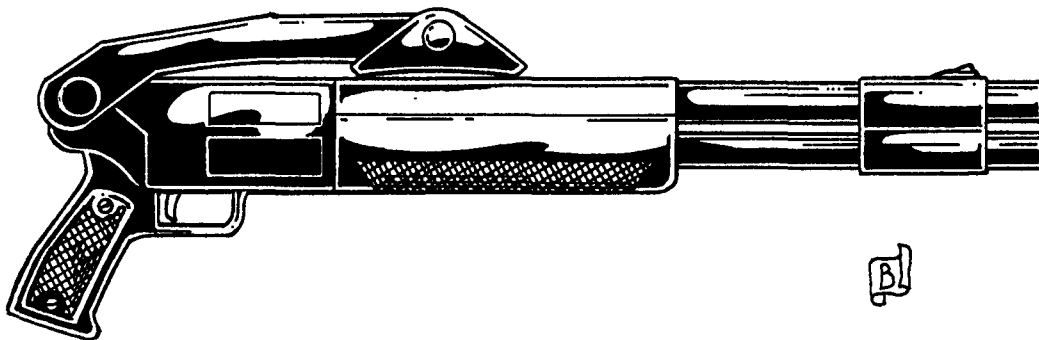

## H-15 "Scattergun" Shotgun

The H-15 is a modern version of an old, pre-Rifts weapon designed to fire the 25 mm M.D. shotshell. These shells contain a number of explosive pellets that pack a wallop but have a short range. H-Brand has produced a double-barreled weapon and a sawed-off versions of the H-15 has become an extremely popular armament among urban criminals.

Weight: 9 lbs. (4 kg)

Mega-Damage: 4D6 M.D.

Rate of Fire: Standard; see Modern Weapon Proficiency Section

Maximum Effective Range: 500 feet (152 m) standard, or 200 feet (61 m) sawed-off.

Payload: 2 shots. Note: It takes two melee attacks/actions (about 16 seconds) to completely reload the weapon.

Market Cost: 20,000 credits, good availability.

Note: Illegal in the Republic of Japan, but can be found on the streets, especially among criminals and those living on the fringe near hostile areas.

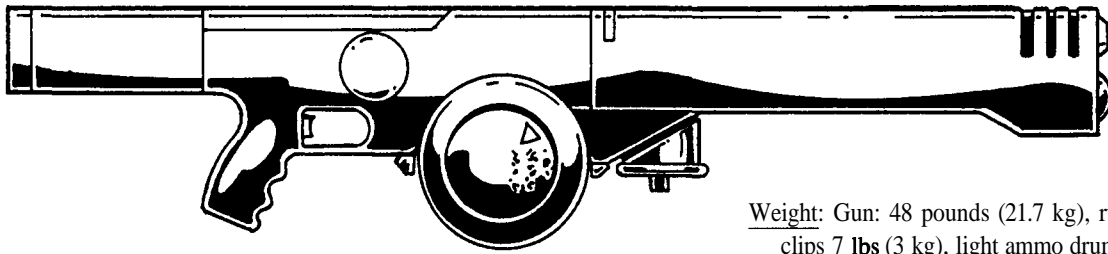

## AT-600 Rail Gun

ArmaTech has spent years and huge sums of money in research of rail gun technology. Their goal has been to develop a weapon light enough to be used by regular infantry soldiers as well as SAMAS and cyborg troops. The AT-600 is their latest breakthrough, a rail gun that retains its knock-down power and damage capabilities, but is lighter and more compact. Even the rounds for the weapon are made of lighter materials to reduce overall weight. The result is a squad support weapon which can be used by anyone with a P.S. of 20 (or higher). The main weight limitation remains with the multi-round ammunition container, so it is still often used as a two-man weapon; one carries and uses the gun, the other carries additional ammunition and assists in setting up the weapon. Thus, like all rail guns, it is most effective as a vehicle or bunker mounted weapon or placed in the hands of a cyborg or power armor.

Weight: Gun: 48 pounds (21.7 kg), rucksack 84 pounds (38 kg), short clips 7 lbs (3 kg), light ammo drums 20 lbs (9 kg), and heavy ammo drums 78 lbs (35 kg).

Mega-Damage: A burst of 30 rounds does 6D6M.D.

Rate of Fire: Bursts and wild only.

Maximum Effective Range: 3000 feet (914 m).

Payload: A short clip holds 300 rounds or 10 full bursts. A light ammo drum holds 600 rounds or 20 bursts. A heavy drum, like those built into the PR-3 rucksack, holds 2400 rounds of ammo, enough for 80 bursts!

Reloading a drum takes three minutes for the untrained, or one minute (4 melees) by those trained in the use of rail guns. A strength of 20 is required to handle the drum.

Market Cost: 65,000 credits; limited military availability.

Note: Available only to the military of the Republic of Japan. Rarely available on the Black Market and when it is, it can cost as much as 100,000+ credits. **H-Brand** has no equivalent.

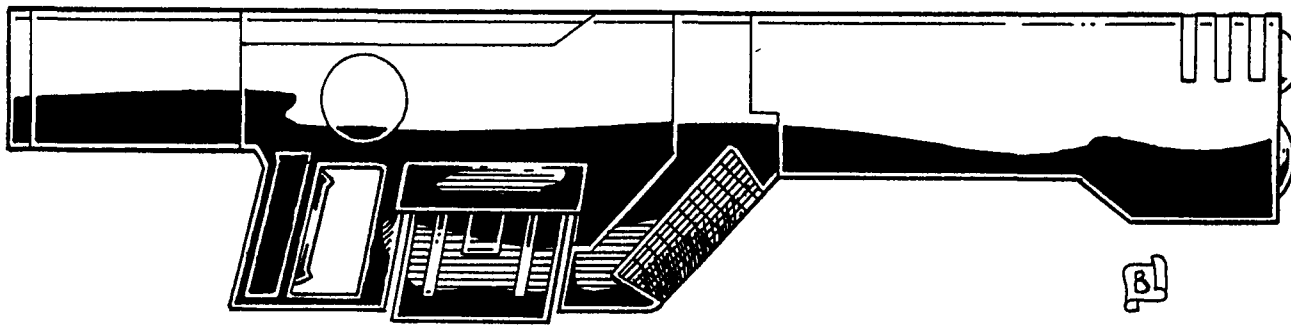

## AT-1200 "Super Rail Gun"

The AT-1200 is basically a larger version of the AT-600 designed for use by power armor, robots or heavy infantry cyborgs. All concern for weight was eliminated in this design. The AT-1200 was developed for superior damage, consequently it is a large gun that fires heavy rounds with greater force. In order to carry and fire this weapon, an individual must have a P.S. of 28 (or higher).

Weight: Gun 228 lbs (103 kg), Clip 20 lbs (9 kg), One AT-1200 ammo drum, which fits on the back of the borg or bot, weighs 200 lbs (91 kg).

Mega-Damage: A burst is 40 rounds and inflicts 1D6×10 M.D. One round does 1D6 M.D.

Rate of Fire: Standard; bursts, spray or wild.

Maximum Effective Range: 4000 feet (1220m)

Payload: A clip holds 400 rounds and is capable of firing 10 bursts. The AT-1200 ammo drum holds 4000 rounds and is capable of firing 100 bursts! Reloading a drum takes three minutes for the untrained, but a mere one minute by somebody trained in the use of power armor. A strength of 28 or higher is required to handle the drum.

Market Cost: 80,000 credits; limited military availability.

Note: Available only to the military of the Republic of Japan. Rarely available on the Black Market and when it is, it can cost as much as 150,000+credits. H-Brand has no equivalent.

## H-600 Rail Gun

**H-brand** has a standard rail gun that comes with a tripod. It requires a combined P.S. of 25, so the weapon is best suited for augmented humans, power armor, borgs and robots.

Weight: Gun: 100 pounds (45 kg), light ammo drum: 40 lbs (18 kg), and heavy ammo drums 80 lbs (36.2 kg).

Mega-Damage: A burst of 40 rounds does 1D4×10M.D.

Rate of Fire: Standard; bursts, spray or wild.

Maximum Effective Range: 4000 feet (1220 m)

Payload: A light ammo drum holds 800 rounds or 20 bursts. A heavy drum holds 2400 rounds of ammo, enough for 60 bursts.

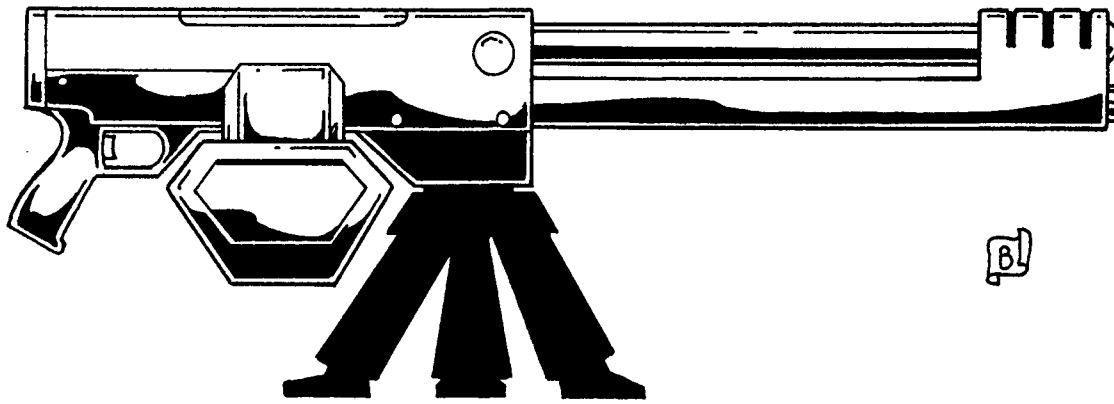

Reloading a drum takes three minutes for the untrained, or one minute (4 melees) by those trained in the use of rail guns. A strength of 20 is required to handle the drum.

Market Cost: 65,000 credits; poor to fair availability.

Note: Illegal in the Republic of Japan and is rare even among criminal organizations.

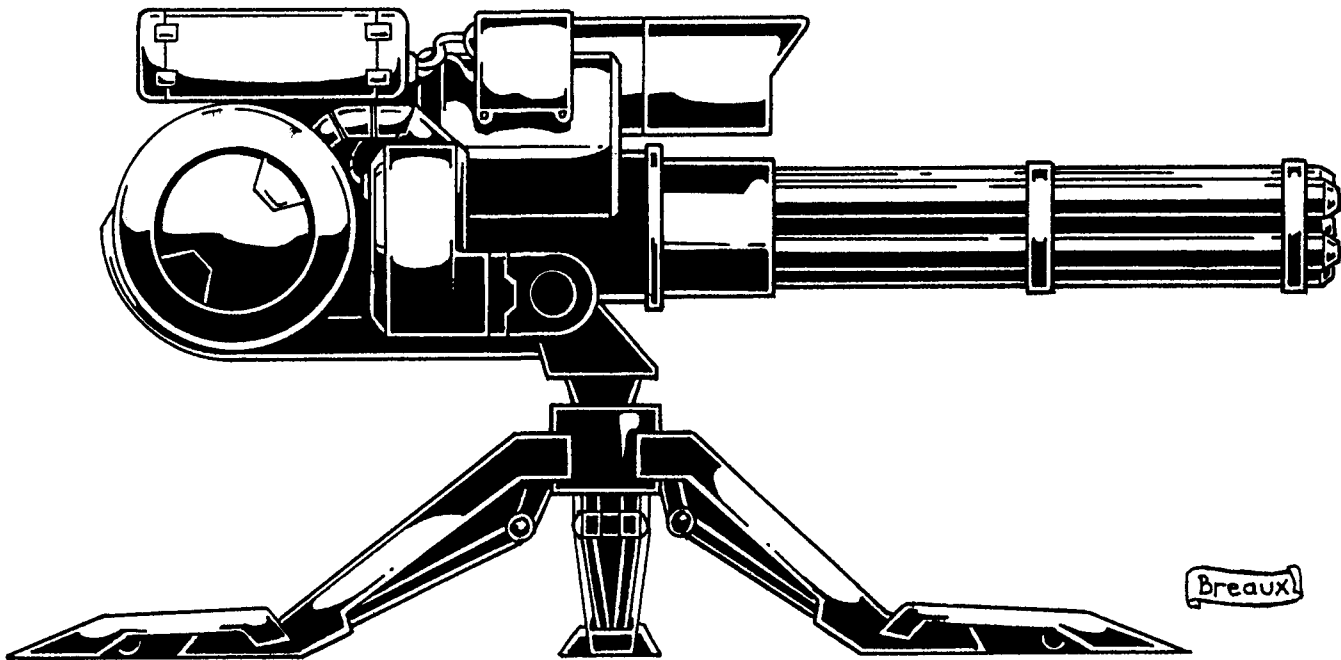

## ARC-2 "Nighthawk" Defense System

The ARC-2 is an automated sentry device designed to detect, recognize and engage the enemy in combat. It is a **gatling-style** rail gun mounted on a tripod with a special **sensor**-array. The radar or **thermo**-imaging sensor (range 2000 **feet/610 m**), combined with an internal computer, pick up and identify intruders by heat signature, from the thousands of patterns stored in its memory. Once an enemy is detected, the rail gun will begin to fire devastating bursts to destroy the enemy target and alert friendly troops. The "Nighthawk" is used in ambushes, to set traps, and defend perimeters either as a stand-alone robot sentry or in conjunction with troops or other defenses.

The ARC-2 can rotate in a 180 degree semi-circle with a forward up and down arc of 30 degrees. Together with its huge payload, the weapon is definitely not man-portable and has to be transported by a vehicle or borg. A coded radio signal can be used to deactivate the sentry or a shut off time can be programmed into the system before it is activated. There is also a fail-safe manual off and on button.

Weight: Gun, includes stand and sensors, 187 **lbs**(85 **kg**), power/ammo pack 320 **lbs** (145 **kg**).

Mega-Damage: 1D6x10 M.D. per 60 round burst

Maximum Effective Range: 2000 feet (610 m); the rail gun can fire up to 4000 feet (1220 m), but is limited by the range of the sensors.

Rate of Fire: Bursts only, up to four times per melee round.

Payload: The power/ammo pack connected to the cannon holds 6000 rounds of ammunition, that's 100 bursts! The pack can only be reloaded by technicians with special equipment, requiring 10 minutes to complete.

Targeting System: Once firing has begun the ARC-2 relies on its motion sensor to locate its targets and its memory to accurately identify the enemy (human, inhuman and vehicular). The computer system chooses the **target(s)** closest to it for destruction. The ARC-2 is extremely effective against many supernatural opponents who are magically invisible, detecting them by heat signature and motion.

Market Cost: 180,000 credits; limited military availability.

Note: Available only to the military of the Republic of Japan. Not available on the Black Market and H-Brand has no equivalent.

---

# Explosives

---

## Missiles

In the Republic of Japan, the use of all missiles and torpedoes are restricted to the military. Non-military explosives may be authorized for industrial purposes such as mining and demolition of buildings.

**Note:** All of the common missile types and explosives found in the **Rifts RPG** and **Triax** are available in Rifts Japan. Advanced technology has seen the production of advanced guidance packages and a few unique items not found anywhere else.

**Heat-Seeking Missiles:** With this guidance package a missile locks onto the specific heat signature of a target. Once a lock is obtained, the missile will continue to follow the target until it hits or runs out of fuel. Heat-seekers gain a +5 bonus to strike.

**Knock-Out Missiles:** These concussion missiles are fundamentally the same as Triax Industries' "Slammers." They are designed to blow opponents off their feet and stun them for several moments. Anyone in the blast radius of the missile is likely (01-88%) to be knocked off their feet and stunned (01-65%). The victim of a direct strike will always be knocked down.

A character, robot or monster knocked down will lose one melee attack/action and initiative. If stunned, the victim will be dazed, -10 to strike, parry, dodge, roll with impact or pull punch, is the last to attack (no initiative) and loses half his attacks/actions per melee round for 1D4 melee rounds! Speed is also reduced by half during this period.

**Mini-Concussion Missiles:** Damage: 5D6 M.D. Blast Radius: 30 feet (9.1 m) Maximum Effective Range: 2000 feet (610 m) Cost: 4000 credits, poor availability.

**Short Concussion Missiles:** Damage: 1D6×10 M.D. Blast Radius: 60 feet (18.3 m) Maximum Effective Range: 6000 feet (1830 m) Cost: 8500 credits, poor availability.

**Medium Concussion Missiles:** Damage: 2D4×10 M.D. Blast Radius: 90 feet (27.4 m) Maximum Effective Range: 6000 feet (1830 m) Cost: 11,000 credits, poor availability.

**Heavy Concussion Missiles:** Damage: 3D4×10 M.D. Blast Radius: 120 feet (36.5 m) Maximum Effective Range: 2 miles (3.2 km) Cost: 20,000 credits, poor availability.

**Heavy-Hitter Missiles:** These missiles have become extremely popular for their damaging capacity. The Heavy-Hitter (HH) is a high explosive (HE) missile which uses a large warhead. The warhead used in a HH missile is usually that of the next highest size. For example, an short-range explosive charge is mounted on a mini-missile. The resulting HH missile has much higher damaging capabilities but has a severely reduced range.

**Mini-HH Missile:** Damage: 1D6×10 M.D. Maximum Effective Range: 1/2 mile (0.8 km) Cost: 5000 credits.

**Short HH Missile:** Damage: 2D4×10 M.D. Maximum Effective Range: 1 mile (1.6 km) Cost: 9,500 credits.

**Medium HH Missile:** Damage: 3D4×10 M.D. Maximum Effective Range: 20 miles (32 km) Cost: 14,000 credits.

**Long HH Missile:** Damage: 3D6×10 M.D. Maximum Effective Range: 30 miles (48 km) Cost: 22,500 credits.

## Torpedoes

Torpedoes are fundamentally missiles designed for propulsion through water rather than the air. High explosive (HE) torpedoes do more damage underwater because water is a better conductor of concussion waves than air. Torpedoes are slower than missiles (about 300 mph/482 kmph) and can usually be "seen" with the naked eye at about 500 feet (152 m) away from its target and detected by sonar miles away. The further away the torpedo is launched, the greater the chances it can be destroyed or evaded before reaching its intended target.

### Torpedo Statistical Data:

Penalties: Torpedoes are -2 to strike at any range longer than a mile (1.6 km). At 1000 feet (305 m), the torpedo's tracking system will follow and hit all but the nimblest targets and is +3 to strike. The problem is that at 1000 feet (305 m), the missile will be in range of almost every known weapon system, allowing the enemy one attempt at blowing it up with their own weapons.

Speed: All torpedoes travel at approximately the same speed of 300 mph (482 kmph)

M.D.C. of Torpedoes: Mini-torpedo: 10 M.D.C., light: 15 M.D.C., medium: 30 M.D.C., heavy: 50 M.D.C., and depth charges have five M.D.C. points. Depleting the M.D.C. will cause the torpedo to detonate the instant it hits zero points. Thus, they can be prevented from reaching their intended target. As a result, torpedoes are often launched in pairs or volleys. Detonating one only has a 33% chance of causing the others to explode as well.

### Cost & M.D.C. Damage

#### Inflicted by Torpedoes & Depth Charges

**Mini-torpedo:** 1D4×10 M.D. (HE or Plasma). Maximum Effective Range: One mile (1.6 km). Cost: 3500 credits each.

**Light Torpedo:** 2D4×10 M.D. (HE) or 1D6×10 M.D. (Plasma). Maximum Effective Range: 5 miles (8 km). Cost: 8000 credits each.

**Medium Torpedo:** 3D4×10 M.D. (HE) or 2D6×10 M.D. (Plasma). Maximum Effective Range: 10 miles (16 km). Cost: 10,000 credits each.

**Heavy Torpedo:** 4D6×10 M.D. (HE or Plasma). Maximum Effective Range: 20 miles (32 km). Cost: 20,000 credits each.

**Depth Charges:** Basically a bomb that is dropped into the water, sinks and detonates when it reaches a particular depth or hits an object. Maximum range/depth: 2000 feet (610 m) deep -automatically explodes at 2000 feet (or any depth between 200 and 2000 feet/61-610m); Damage: 2D4×10 M.D. (HE); Cost: 4500 credits each.

## AT-D10 Satchel Charge

The standard issue explosive charge for the military is a 4 pound (1.8 kg) block of plastique with attached detonator packed in a canvas satchel. The flip of a switch activates a 3 minute delay for the charge.

M.D. Damage: 3D4×10 M.D. (blast radius of 30 feet/9.1 m).

Maximum Effective Range: The satchel charge is not very aerodynamic, but can be thrown a distance of 2D4×10 feet (6.1 to 24.4 m). Cost: 4600 credits.

Note: Available only to the military of the Republic of Japan. Occasionally available on the Black Market or **H-Brand** at around the same cost.

## Hand Grenades

A hand grenade is a small, softball-sized explosive canister designed for throwing and exploding. Average effective throwing range is about 100 feet (30.5 m). **Note:** Grenades are illegal and hard to acquire in the Republic of Japan. Their use is limited exclusively to the police and

military. These explosives may be available to mercenaries and adventurers serving other kingdoms or from select H-Brand dealers.

**Fragmentation Grenade (anti-personnel) AT-D25 (Light Frag.):** 2D6 M.D. to everything in a blast radius of 20 feet (6.1 m). Cost: 200 credits each.

**AT-D26 (Heavy Frag.):** 3D6 M.D. to everything in the blast radius of 30 feet (9.1 m). Cost: 250 credits each.

**AT-D28 High Explosive Grenade (anti-armor):** 4D6 M.D. to a 6 foot (1.8 m) blast area. Cost: 150 credits.

**AT-D29 Plasma Grenade:** 5D6 M.D. to a 12 foot (3.65 m) area. Cost: 350 credits.

**AT-D30 Stun/Flash Grenade:** This riot/anti-terrorist weapon is designed to disorient and confuse criminals who are holding hostages in confined places. The grenade makes a loud exploding boom and emits a bright flash, followed by a shower of white-hot **sparklettes** and some white smoke. The flash, burning sparks, and smoke should blind and startle any character without environmental armor or protective goggles. The victims of a **stun/flash** grenade are -8 to strike, parry and dodge, -1 on initiative and lose one melee attack/action for the next 1D4 melee rounds (15 to 60 seconds). Even those in armor should be momentarily distracted for 1D4 seconds and lose initiative. Cost: 100 credits.

**AT-D31 Tear Gas Grenades:** The gas will instantly affect all characters without protective masks or environmental body armor. The eyes burn, sting and water profusely, causing great discomfort and seeing clearly is impossible. The gas also makes breathing difficult and irritates exposed skin. The effects last for 3D4 minutes. The 25 foot (7.6) cloud dissipates in about five minutes unless blown away by the wind (dissipating quickly in 1D4 minutes). The victims of tear gas are -10 to strike, parry and dodge, -3 on initiative and lose one melee **attack/action** for each of the next 1D6+1 melee rounds. Those in environmental armor are completely safe and not affected. Cost: 200 credits.

**AT-D32 Concussion Grenade:** This explosive canister is not designed for mass destruction but to knock-down and stun victims. The materials of the canister are instantly melted in the blast instead of becoming deadly projectiles. When detonated the AT-D32 erupts in a 30 foot (9.1 m) blast radius causing 1D4 M.D. to everyone within. Individuals caught in the blast are likely (01-88%) to be knocked off their feet and stunned (01-65%).

If only knocked down, the victim of this attack will have ringing ears and a headache, but only loses one melee **action/attack** and initiative. If stunned, the victim is dazed, -10 to strike, parry, dodge, roll with impact or pull punch, is the last to attack (no initiative) and loses half his attacks/actions per melee round for 1D4 melee rounds! Speed is also reduced by half during this period. Cost: 100 credits.

**AT-D40 Smoke Grenades** release a thick cloud of smoke that covers a 20 to 40 foot (6.1 to 12.2 m) radius. The smoke obscures vision in and through the cloud from those on the outside of it. Infrared cannot penetrate a smoke cloud or be used inside a smoke cloud. Those inside the cloud will be blinded and have trouble breathing while inside it. Those who are not protected by environmental suits or gas masks and goggles will be -5 to strike, parry and dodge and are -1 on initiative. Attackers firing into/through the cloud are shooting wild. Note that passive nightscopes will work in a smoke cloud. Cost: 50 credits.

**Hand-held Flare:** This is the type of item truck drivers and road patrols use to signal for help or to warn others of an accident or danger. The flare burns for 20 minutes. Cost: one credit each.

**Parachute Flares:** This pyrotechnic device usually comes in a hand-held, throw-away launch tube. Three seconds after launching the flare, it ignites into a bright, sparkling light that slowly drifts back down to earth. While in the air, the flare burns for 60 seconds and illuminates an area roughly 150 feet (45.7 m) in diameter. Cost: 10 credits each. **Note:** This is NOT a weapon, but if shot into a person, the flare does 6D6 S.D.C. each melee round for one minute (four melees). There is also a 50% chance of causing combustibles to catch fire.

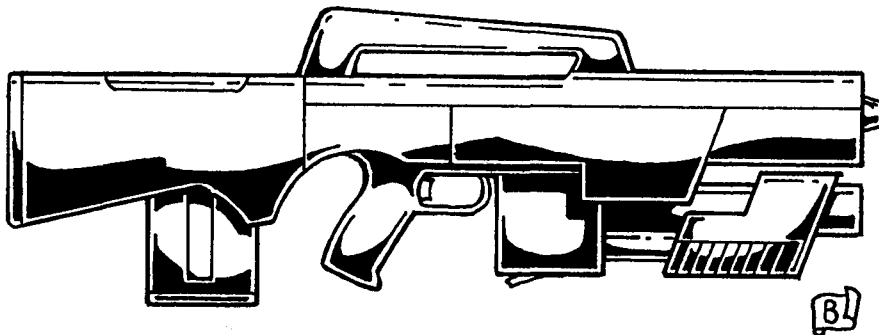

## AT-25 Pump Grenade Launcher

A pump-action grenade launcher with a light laser. The weapon is somewhat reminiscent of the Coalition **States'** C-14 "Firebreather" and the **TX-16** pump rifle. It can fire a variety of grenades and is in wide service both in the military and by police units. The launcher can take a lot of punishment but still delivers rounds right on target. The range, damage and area of effect vary with each cartridge.

Weight: 10 lbs (4.5 kg)

Mega-Damage: Grenade: Varies with type of round. Laser: 2D6 M.D.

Rate of Fire: Laser: Standard. Grenade Launcher: one aimed, or four fired in rapid succession (burst or spray).

Maximum Effective Range: Grenade Launcher: 1200 feet (365 m). Laser: 2000 feet (610 m)

Payload: Laser: 30 shots per standard **E-clip**, 12 rounds for grenades.

Grenade Type: Any as described above.

Cost: 28,000 credits; 34,000 on the Black Market.

**Note:** Available only to the military, police agencies and authorized corporate security forces. H-Brand has a knock-off called the H-25 Super Rifle that costs 31,000 credits, but range is 20% less than the AT-25 for both weapons and it weighs 14 lbs (6.3 kg); poor availability inside the Republic, fair to good outside of it.

## CC-26 Bomb Detector

This hand-held unit is a combination of metal detector and chemical sensor which in concert can detect the presence of land mines and explosives. Despite its limited range, a mere 75 feet (22.5 m), the CC-26 is an excellent tool for both the military and police forces. The unit detects explosives with a 65% level of accuracy.

Weight: 3 lbs (1.4 kg).

Maximum Effective Range: 75 feet (22.5 m).

Cost: 950 credits, poor availability.



## Land Mines

The Republic of Japan uses a variety of land mines in protection of its borders. These weapons are closely guarded by military personnel and are rarely found on the black market or available from **H-Brand**.

Detecting Mines: Travelling on foot and looking for mines, either the detect ambush or detect concealment skills at -10% can be used to spot land mines and booby-traps. If the individual placing the mine or booby-trap makes a successful camouflage skill roll then there is an additional -20% penalty.

Vehicles can be outfitted with a basic mine detector for 50,000 credits. This unit has a 40% chance of locating mines before they are struck and detonated, but will also indicate harmless metal fragments as well (fragments must be the size of a soccer ball or bigger). The basic system can be "fine-tuned" and enhanced +10% for an additional 20,000 credits up to a maximum of 90% efficiency, but those are rare (most are at 70%). A pilot can try to detect ambush or detect concealment skill rolls, but is -25% if travelling is at a crawl and -50% if travelling at over 30mph (**50kmph**).

**Note:** Land mines are illegal and hard to acquire in the Republic of Japan. Their use is limited exclusively to the police and military. These explosives may be available to mercenaries and adventurers serving other kingdoms or from select H-Brand dealers.

### AT-D50 Anti-Personnel Mine

The AT-D50 is the simplest form of land mine, a small platter charge detonated by 200 pounds (90 kg) of pressure. With several minor modifications, the AT-D50 can be used with a trip wire that will cause the mine to explode if 30 pounds (13.6 kg) of pressure is exerted on the line.

Weight: 12 lbs (5.4 kg)

Mega-Damage: 6D6 M.D.

Blast Area: 12 feet (3.65 m)

Black Market Cost: 4500 credits, fair availability.

Notes: The mine casing has 15 M.D.C. which, if depleted, will detonate the contained explosives. There is a -5% penalty to camouflage skill to conceal the mine due to its size and bulk.

### AT-D52 "Bullet" Anti-Personnel Mine

The AT-D52 is an extremely small mine with relatively small damage capabilities. But due to the small size it is extremely hard to detect; -30% penalty to detect concealment or ambush. The AT-D52 is a plastic cylinder, three inches in length (75 mm) and a little over an inch (30 mm) in diameter. Contained within the tube is a grenade projectile from the AT-25 launcher, resting atop a steel pin. The tube is embedded in the ground so that only the top protrudes slightly. Pressure from a foot-fall causes the cartridge to fire.

Weight: 1 lb (0.45 kg)

Mega-Damage: 4D6 M.D.

Blast Area: 1 foot (0.3 m)

Black Market Cost: 500 credits, poor to fair availability.

Notes: The plastic tube which holds the round has 20 S.D.C. Damage of one point of M.D. will cause the grenade round to detonate. Arrows on both sides of the mine indicate which end is the top. Due to its small size, this device gets a bonus of +15% to camouflage skill rolls.

### AT-D54 Anti-Armor Mine

A large platter-style mine akin to those used before the Rifts. Pressure of 500 pounds (225 kg) will detonate the mine's explosive charge.

Weight: 45 lbs (20.25 kg)

Mega-Damage: 2D6x10 M.D.

Blast Area: 15 feet (4.5 m)

Black Market Cost: 18,000 credits, fair availability.

Notes: The metal casing has an M.D.C. value of 5 to protect the explosive. If the case is depleted, the mine will detonate prematurely. A -25% penalty applies to the camouflage skill when attempting to hide this mine.



---

# Power Armor

---

Power armor is a form fitting, robot exoskeleton designed for combat pilots. Basically a robot suit, it offers a form of mechanical augmentation that does not require the user to submit to any physical alteration (although the majority of Japanese pilots have cybernetics). The human pilot steps into it and activates the armor. The suit becomes a self-contained environmental system and offers superhuman strength, speed, and mega-damage capabilities to its pilot. Many can fly and/or have a variety of weapon systems.

Power armor is always a one person unit that is roughly human size, although most suits add one to four feet (0.3 to 1.2m) to one's height. Some power armor are larger and may tower as high as twelve feet (3.65 m). Anything larger is usually considered to be a full robot vehicle.

## Power Armor Features

**All Power Armor have the following features:**

- 1. Nuclear Powered:** Which means they have an effectively unlimited fuel capacity and power source. Average life is 15 to 25 years.
- 2. Radar:** Can identify and track up to 24 targets simultaneously, at a range of 20 miles (32 km).
- 3. Combat Computer:** Calculates, stores, and transmits data onto the Head Up Display (H.U.D.) of the pilot's helmet. It is tied to the targeting computer.
- 4. Targeting Computer:** Assists in tracking and identification of enemy targets. 20 mile range (32 km).
- 5. Laser Targeting System:** Assists in the selection and tracking of specific targets and adds a bonus of +1 to strike when using long-range weapons. Does not apply to hand to hand combat or SAMAS.
- 6. Thermo-Imaging and Infrared Optics:** Optic systems that can see heat images and the infrared spectrum of light. Range: 2000 feet (610 m). Ultraviolet optics or passive **nightvision** systems may be included (same range). Special optics and sensors will be noted.
- 7. Telescopic Zoom:** 2x to 20x magnification HUD and video-screen display. Most robots and some power armor also have video recording capabilities. Range: 6000 feet (1830 m).
- 8. Radio Communication:** long-range, directional communication system with an effective range of about 500 miles (800 km). As well as a directional, short-range radio with a 5 mile (8 km) range. Plus a built in loud speaker; 80 decibels.
- 9. External Audio Pick-up & Loudspeaker:** A sound amplification listening system enables the pilot to pick-up, amplify and hear a whisper 300 feet (91.5 m) away.  
The loudspeaker amplifies the pilot's voice like a bullhorn to communicate and make announcements to those around him. Range is roughly 4000 feet (1220 m) depending on ambient noise.
- 10. Voice Actuated Locking System:** The access panels or hatches to the power armor or robot are sealed by an automatic locking system. A six digit spoken code or password programmed to a specific voice(s) pattern is typical. A manual key pad is provided in case of system failure or the need to override or change the code.
- 11. Complete Environmental Battle Armor:** All power armor is designed for use in hostile environments including toxic clouds, underwater (500 feet/152 m average max. depth unless stated otherwise) and space. The following features are standard:

- Computer controlled life support system.
- Internal cooling and temperature control.
- Artificial air circulation systems, gas filtration, humidifier.

- Computer controlled, independent oxygen supply and purge system that automatically engages in low oxygen or contaminated air environments. Eight hour oxygen supply.
- Insulated, high temperature resistant shielding for up to 400 degrees centigrade. Normal fires do no damage. Nuclear, plasma, and magic fires do full damage.
- Radiation shielded.
- Polarized and light sensitive/adjusting tinted visor.

**Note:** Approximately 88% of the power armor and robot pilots of the Republic of Japan have two to six implants, including a head-jack for a direct link to computer and targeting systems. This adds the bonuses of +2 on initiative, +1 to roll with impact or fall, +1 to pull punch and +5% on all piloting skills.

**Prowl Penalty:** Unless noted otherwise, all power armor have a prowl penalty. Light armor under 9 feet (2.7 m) tall are -50% to prowl. Large, heavy and/or bulky power armor cannot prowl at all!

## Power Armor of Japan

AT Samurai SAMAS  
AT-USA-10 Glitter Boy  
AT-USA-10A1 Point Glitter Boy  
AT-USA-10A2 Hawkeye Glitter Boy  
ATPA-85 Power-Spy  
H-Brand Ninjabot  
IPA-40 Dai-Katana Bugei  
IPA-45 Ikusa  
IPA-50 Grenadier  
IPA-60 Tazu-Tengu (air)  
IPA-62 Super-Tengu (air)  
IPA-70 Mizu Mi (underwater)

---

## Japanese SAMAS Power Armor

---

The **Glitter Boy and SAMAS** are two of the most famous power armor suits on Rifts Earth. The Glitter Boy armor is recognized as technology that has survived the ravages of time and the carnage of the Great Cataclysm. It is known to have been developed by the Old American Empire toward the end of the Golden Age of Man. The SAMAS is believed to be the original creation of the new power of North America, *The Coalition States*. However, a visit to Rifts Japan will reveal otherwise. Erin Tarn and other rogue scholars have been proclaimed enemies of the States because they have dared to suggest that the Coalition States' (CS) power base is built upon ancient military and scientific knowledge from the Old American Empire.

Erin Tarn once wrote in the infamous chapter of her diary entitled, **A study in the corruption of the soul; circa 78 PA:**

I do not have absolute proof, but I believe that the Coalition government holds in its forbidden archives many of the secrets of the Old American Empire.

When I was a young woman, just beginning my journeys and writing, I visited the Great Library of Chi-Town. This was several years before the Coalition States government rose to power and Chi-Town was a free city (although **Karl Prosek** and his elite were already a force to be

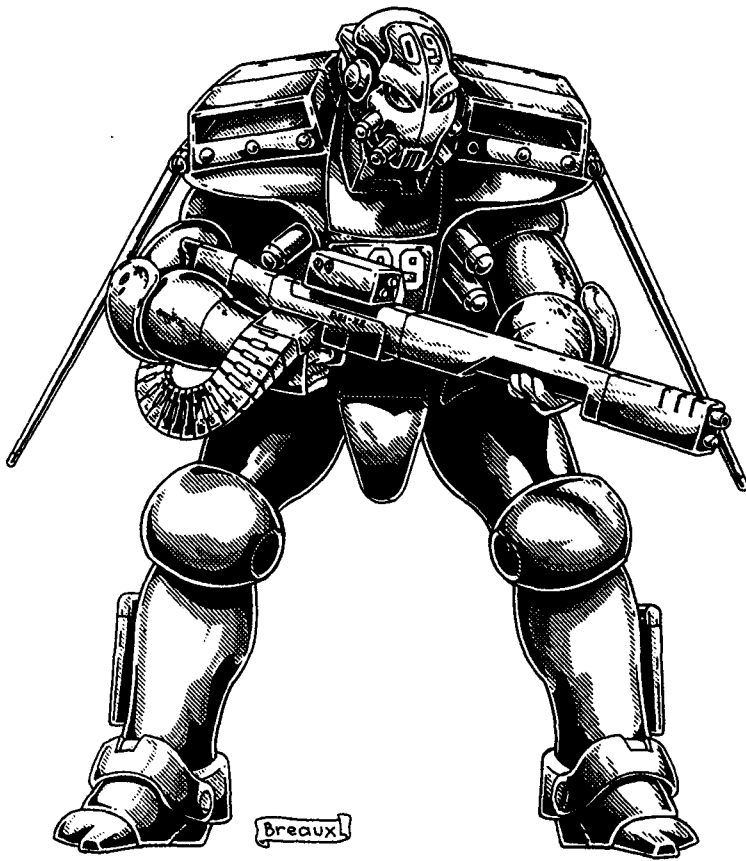

reckoned with). I spent months rummaging through the Great Library's musty depths. There I saw volume after volume of ancient books, magazines, computer files and video disks on an endless number of subject matters. One incident, **however**, haunts me. One of the library's archivists, a gentle, studious woman named **Joan**, was reviewing a recently discovered computer disk that was showing the drawings and schematics of some sort of **pre-Cataclysm** machine. I remember asking whether it was a robot. My eyes were as wide as apples and my voice must have dripped with a tone of awe and reverence at seeing a piece of history from a world that had perished hundreds of years earlier.

Joan smiled at me, hit a button and said, "Watch this." Suddenly, the screen changed to an animated representation of the machine as a 3-D computer simulation. It was a suit of armor with a man inside like the legendary **Glitter Boy**. A pair of powerful **thrusters** sent the armor soaring into the air and down the concrete caverns of a modern city. To my recollection, the video presentation lasted for 20 minutes, but in reality it was probably less than five. When the simulation ended, live film footage appeared. A scientist in a white lab-coat stood before a real-life version of the suit. I remember it being grey or silver with light blue highlights and the flag of the American Empire emblazoned on its helmet and left breast plate. The man explained that the suit of power armor was one of three Beta-Test units for what he called a *Strategic Assault Manned Armor System*.

The flying armor was originally designed for police and law enforcement agencies as a means to fight terrorism, conduct rescue operations, patrol cities and even fight fires. However, the prototypes had outperformed its designers' expectations. The man explained that it was the ideal *urban assault weapon*, capable of maneuvering through city streets at amazing speeds and engaging both enemy ground and air troops as well as those secured on the upper floors of buildings or fighting from rooftops. The flying armor was also said to be a wonderful all-purpose weapon that could serve as an infantry, defensive, support, clean-up, and rescue unit in the field of combat. He attributed much of its success to the armor's co-developers. A trio of Oriental scientists from the Japanese Empire, stepped forward and bowed. I have since forgotten the name of the corporation they represented, but if I recall correctly, it sounded something like Ameritech or **Armortech**.

I remember thinking how **marvelous** and frightening such a device could be. It never ceases to amaze me that humankind is capable of creating such incredible machines. Devices capable of saving life or destroying it utterly. That's why I froze in awe and terror when I saw my first patrol of Coalition SAMAS streak across the sky. The SAMAS is the armored nightmare I saw that day so long ago on the computer screen. The CS has given it their classic Death's Head motifs, added menacing spikes, a deadly rail gun and colored it black, but it is identical in every other way. It struck me as those around me pointed and muttered the word "SAMAS," that SAMAS could be the acronym for *Strategic Assault Manned Armor System* — of course I may be incorrectly remembering what I heard back in the Great Library, but I think not.

That day I also shed the last vestiges of my naivety. Until that moment, I could not bring myself to believe that the Coalition government was secretly behind the destruction of the Great Library of Chi-Town.

According to CS authorities, an unnatural (magic?) explosion and fire obliterated the Great Library. Less than 5% of its treasures were saved. Scholars proclaimed it the greatest tragedy since the loss of the library at ancient Alexandria. Worse was the loss of life. One hundred and forty-three people died in the Library and hundreds of others were injured. But the death toll would climb even higher over the weeks that followed, as the CS hunted down and brought the alleged perpetrators to justice.

The fledgling Coalition States government proclaimed the incident a deliberate and wanton act of murder and destruction at the hands of the fanatical Federation of Magic. The military used it as an excuse to wage one of its bloodiest campaigns against these malevolent mages. In so doing, the government leaders won the hearts of the Chi-Town people and made a giant leap in political power. However, no practitioners of magic were safe. Hundreds not even remotely affiliated with the **sociopathic** Federation were interrogated and slaughtered. Storm troopers also invaded the homes of men of learning, sacked their houses, and seized all their belongings, particularly books and video and computer disks. Those who resisted were slain. My friend, Joan, was one such victim. The official records claim that she was a conspirator in the destruction of the library and had been found trying to escape with computer disks of a "dangerous military nature." This I know is a lie. Joan was dedicated to the library and the preservation of knowledge. More likely her crime was being an educator and knowing too much. After seeing the Coalition SAMAS, I have often wondered if the "dangerous military" data she was said to be carrying was the disk of the American SAMAS power armor I myself had seen just a few years earlier.

I was away on one of my many journeys, so I was not an eyewitness to the event of that day, but I have talked to many who were and have heard many frightening tales and theories about what really happened. The most likely is this: It is no secret that Emperor **Karl Prosek** and the administration of the Coalition States believe that knowledge in the hands of the people is a bad and dangerous thing. This sentiment continues to this day, which is why books are forbidden. Less than a quarter of the Chi-Town population is literate (except for the elite, powerful, and rich), and education of the masses is a crime. Emperor Prosek saw the unrestricted knowledge at the Great Library and free thinking as a danger to his bid for power. At the same time, he realized that the Library contained lost technology, history and knowledge that could make his fledgling empire strong. So it was that he and his henchmen hatched a plot to fake an attack on the Great Library of Chi-Town, steal all the books and knowledge for the scrutiny and exclusive use of the government and control all of its dangerous secrets. Controlled by the government, lost knowledge such as the SAMAS wouldn't have to be shared with other people or rival kingdoms. Indeed, the knowledge stolen from the Great Library is the foundation of Chi-Town's computer network, communications system, propaganda network, and medicine, not to mention the SAMAS, sky-cycle, Death's Head transport, robots, Dog Boys and other military and technological achievements!

"Ever the scheming megalomaniac, Emperor **Prosek** implicated the Federation of Magic, for once innocent of any wrongdoing, and used the fires of hate and fear to weaken his old enemy. To insure that his conquest of the Great Library was complete, he had everyone even remotely associated with the Library systematic tracked down, interrogated and secretly executed. Their confiscated belongings added to the treasures of the Great Library now safely in his hands. "No witnesses to history" was the whispered battle-cry of this secret war for Chi-Town.

Less than 3% of the Great Library escaped seizure. Of the 260 people who worked at the Library, only 16 survived; the head Librarian, Plato, now the Council Head at **Lazlo**, was counted among them. I shall save his account of events for another day. An additional 1130 "conspirators," all scholars, theologians, educators and scientists, were apprehended and executed as traitors to the State of Chi-Town. An estimated 2200 others disappeared without a trace and are presumed dead and buried in a mass grave somewhere beneath the walls of the Great City.

I wish I could say that this horrible story is the concoction of madmen or the disenchanted, but I fear it is true. Few dare tell the tale, because to do so is to be branded a traitor and criminal against the Coalition States. Such is the distinction I have won, because I believe it is a story that must be told. And more important, a story that must be heard. The people of the Coalition States are no more evil or cruel than any other. Many of the government's accomplishments save and protect lives during a period of history fraught with danger and dark forces that would devour us all. Still, as the sight of the SAMAS reminds me, the soul at the heart of the CS Empire is as dark as any I've seen, and I fear where that darkness shall lead us and how many more innocents must pay the price for its hunger for power."

## ArmaTech "Samurai Class" SAMAS Power Armor

In the 20 years since **Nagasaki's** reappearance in the post-apocalyptic environment of Rifts Earth, the government has swiftly built a pow-

erful, defensive army. Advanced, modified versions of the SAMAS and Glitter Boy have become an important part of that army.

The SAMAS of Japan is fundamentally the same as the Coalition States, except for cosmetic considerations (it resembles ancient samurai armor), some minor improvements and the replacement of the traditional rail gun with a particle beam gun. Three small searchlights are built into the belly and two others are located on the helmet. Each forearm has a pair of slots that, at a quick glance, might appear to be more lights, but are actually mini-missile launchers.

The versatile power armor is used to patrol, protect and defend the cities of the Republic as well as for military reconnaissance, infantry strikes, defensive support, rescue, and seek and destroy missions. 10,000 SAMAS defend Nagasaki, with an additional 22,000 assigned to military duty and the defense of other communities.

**Model Type:** PA-10A

**Class:** Strategic Armored Military Assault System

**Crew:** One

**M.D.C. by Location:**

Shoulder Wings (2) — 50 each

Main Rear Jets (2) — 75 each

Lower Maneuvering Jets — 25 each

Particle Beam Gun — 90

Forearm Mini-Missile Launchers (2; forearms) — 50 each

\*Head — 90

\*\*Main Body — 290

\* Destroying the head of the power armor will eliminate all forms of optical enhancement and sensory systems. The pilot must rely on his own human vision and senses and he loses any power armor combat bonuses to strike, parry, and dodge! Note: The head is a small and difficult target to hit (shielded by exhaust tubes and ammo drum). Thus, it can only be hit when an opponent makes a *called shot* and even then the attacker is -3 to strike.

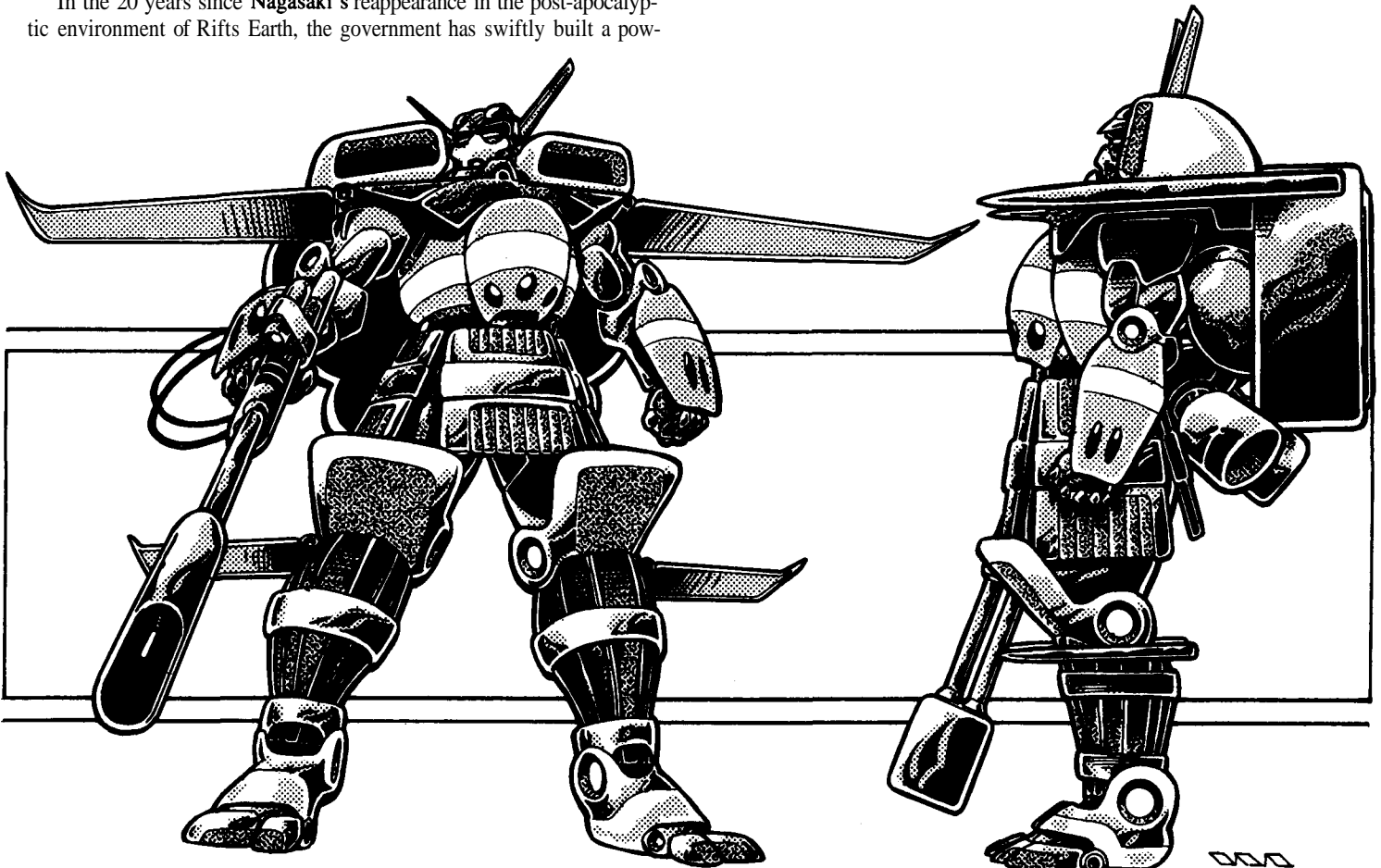

\*\* Depleting the M.D.C. of the main body will shut the armor down completely, making it useless. **Note:** Destroying a wing will make flight impossible. However, even with no wing(s), the SAMAS can make jet-powered leaps and hover in a stationary position above the ground.

### Speed

**Running:** 60 mph (96 kmph) maximum. Note that the act of running does tire out its operator, but at 10% of the usual fatigue rate thanks to the robot exoskeleton.

**Leaping:** The powerful robotic legs can leap up to 15 feet (4.6 m) high or lengthwise unassisted by the **thrusters**. A jet **thruster assisted leap** can propel the unit up to 100 feet (30.5 m) high and 200 feet (61 m) across without actually attaining flight.

**Flying:** The rocket propulsion system enables the SAMAS to hover stationary or fly. Maximum flying speed is 320 mph (512 kmph), but cruising speed is considered to be 150 mph (240 kmph). Maximum altitude is limited to about 6000 feet (1828 m).

**Flying Range:** The nuclear power supply gives the SAMAS decades of life but the jet rockets get hot and need to cool after a maximum of ten hours of flight whenever travelling at speeds above cruising, and after twenty hours at cruising speed; can fly indefinitely with periodic rest stops.

### Statistical Data

**Height:** 8 feet (2.4 m)

**Width:** Wings down 3.5 feet (1.06 m)  
Wings extended 11 feet (3.3 m)

**Length:** 4 feet, 6 inches (1.4 m)

**Weight:** 340 lbs (153 kg) without particle beam gun.

**Physical Strength:** Equal to a P.S. 30

**Cargo:** None

**Power System:** Nuclear, average SAMAS energy life is 20 years.

**Cost:** 1.6 million credits for a new, undamaged, full-powered suit complete with particle beam rifle. Rarely available on the black market, but when it is, the cost is usually 3-4 million. **H-Brand** does not have a copy and cannot duplicate the **P-beam** rifle.

## Weapon Systems

**1. AT-P1000 SAMAS Particle Beam Rifle (1):** This is standard equipment for the Japanese SAMAS. It is incredibly powerful, accurate, and lightweight for a heavy P-beam rifle (some would say cannon). A pair of cables connect the weapon to the armor's nuclear engine, giving it an effectively unlimited payload! If the power cords are severed (each has 6 M.D.C.), the gun holds 3D4 charges before it is empty, however, a conventional **E-clip** can be used in an emergency, providing 10 shots per clip. Of course rail guns and other weapons can be substituted as desired or necessary.

The item that looks like a targeting scope is actually a short-range laser (the power armor has special optics so a scope isn't required). It is used as an alternative to the lethal pounding that the P-beam gun provides.

**Primary Purpose:** Assault

**Secondary Purpose:** Defense

**Weight:** 42 lbs (18.9 kg)

**Mega-Damage:** Particle Beam: 1D6×10 M.D. per blast. Laser: 3D6 M.D.

**Rate of Fire:** Equal to number of combined hand to hand attacks (usually 4-6). Each blast counts as one melee action. The laser and P-beam cannot be fired simultaneously.

**Maximum Effective Range:** P-beam: 2000 feet (610 m). Laser: 1600 feet (488 m).

**Payload:** Effectively unlimited when connected to power supply by cables. 10 shots per standard E-clip.

**2. AT-M2 Rocket Launchers (2):** Each forearm contains a pair of small mini-missile rocket launchers.

**Primary Purpose:** Anti-Aircraft and Anti-Armor

**Secondary Purpose:** Defense

**Missile Type:** Any mini-missile can be used, but standard military issue is armor piercing (1D4×10 M.D.) or plasma (1D6×10 M.D.). AT-AAAD Anti-Armor Dissolver missiles or stun types are also common.

**Mega-Damage:** Varies with missile type.

**Range:** Usually about a mile (1.6 km).

**Rate of Fire:** One or two.

**Payload:** Four; two per each forearm.

**3. AT-N20 Neural Stick (1):** A neural stick and a **sidearm**, typically a stun-gun, laser pistol or **vibro-katana** (3D6 M.D.), are attached to the inside of the lower armor plates or with a belt.

**Neural Stick Physical Damage:** 1D6 S.D.C. plus P.S. attribute bonus (if any) when used a clubbing weapon. The stick can parry S.D.C. and M.D. weapons like **vibro-blades**.

**Stun Damage:** Victims struck by the neural stick must roll to save vs non-lethal **poison/attack** and need a 16 or higher to save. A successful save means the victim loses one melee action from the jolt but is otherwise unimpaired. A failed roll to save means the character is stunned: -7 on initiative, -5 to strike, parry, and dodge, and reduce melee actions/attacks, speed and skill performance by half. The character must save each time he or she is struck.

**Stun Duration:** 2D4 melee rounds. The duration and penalties are increased 2D4 melee rounds for every hit by the stick, plus a cumulative chance of 15% per each subsequent hit that the character will be rendered unconscious for 1D4 minutes.

**Limitations:** The stick is ineffective against environmental M.D.C. body armor, power armor, and full conversion borgs, but is effective against Dog Pack armor and half suits, or body armor without a helmet (not fully environmental without the helmet attached). Partially reconstructed borgs, juicers and crazies are all +2 to save and the stun effect lasts half as long. No effect against robots, androids, and most supernatural beings and creatures of magic.

**4. Energy Rifles** and other weapons can be substituted in an emergency or as a back-up weapon. Space limitations and the bulk of the armor limits additional handguns or rifles to one.

**5. Hand to Hand Combat:** Rather than use a weapon, the pilot can engage in mega-damage hand to hand combat. See **Power Armor Combat Training** in the Robot Combat section of *the Rifts RPG*, pg. 45.

**6. Sensor System Note:** The SAMAS has full optical systems, including laser targeting, telescopic, passive nightvision (light amplification), **thermo-imaging**, infrared, ultraviolet, and polarization. Plus all other features common to all power armor.

**Sensor Bonuses:** Applicable to long-range weapon combat only, not hand to hand. +2 to strike and +1 to dodge. See **Power Armor Combat Training** in the Robot Combat section for other bonuses.

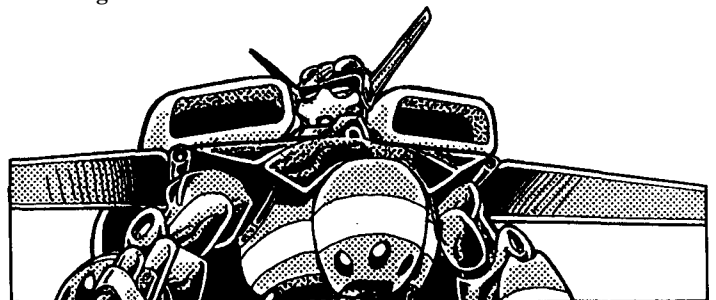

# Glitter Boy Power Armor

The Glitter Boy was another American power armor that was turned over to **ArmaTech** Industries for additional research and development.

The widespread use of Glitter Boys in the Republic of Japan far surpasses that of any other organization in the world! Approximately 12,000 traditional **G10** Glitter Boys, 8400 **G10A1** Point Glitter Boys and 5000 **G10A2** Hawkeye Glitter boys are currently part of the Republic's defenses. This has led to the development of large unit tactics for these robot powerhouses and has eliminated the need for conventional tanks! Unlike conventional armored vehicles, the **humanoid** shape of the machines makes them truly all-terrain capable, requiring only one pilot, and have the **firepower** of a tank and are generally faster, more **maneuverable**, and able to navigate the streets and even the corridors of most buildings in urban combat settings. This makes them perfect for the strategic defense of the heavily populated cities of the Republic of Japan.

Glitter Boys intended for civil defense have been modified. The most notable change is the replacement of the famous Boom Gun with precision shoulder-mounted laser cannons, devastating particle beam guns or mini-missile launchers. However, the classic **USA-G10** Glitter Boy with Boom Gun continues to be used by the frontline infantry troops that defend the outskirts and wilderness areas of the Republic. Variant GBs and weapon systems are unique to Japan and are not found anywhere else in the world! Nations such as the NGR or Free Quebec would love to get their hands on these new models should the Republic of Japan begin relations with other world governments.

Entire Glitter Boy divisions have been sent into the field to engage the enemy. This has included rival kingdoms, **Horune** pirates (see *Rifts Underseas*), bandits, hostile dragons, **elementals**, demons, and numerous other supernatural invaders. The existence of a Demon Sea (Bermuda Triangle) type dimensional anomaly off the southeast coast of Japan, the apparent return of ancient gods, anti-technology fanatics, and the many ley lines and nexus points that attract monsters and creatures of magic, put the Republic and all humanoid life in constant danger.

## Traditional Glitter Boy Power Armor (Excerpted from the Rifts RPG)

The Glitter Boy is so heavily armored and powerful that it is sometimes considered a robot vehicle, rather than a suit of power armor. However, it does fit all the criteria for the power armor classification. See the **Rifts RPG** for a full description.

**Model Type:** USA-G10

**Class:** Laser Resistant Armored Infantry Personnel Assault Unit

**Nickname:** Glitter Boy

**Crew:** One pilot

**M.D.C. by Location:**

Head — 290

Arms (2) — 270 each

Hands (2) — 100 each

Rail **Gun/Boom Gun** (1; over right shoulder) — 175

Rail Gun Ammo Drum (1; large, on back) — 250

Stabilizing **Thrusters** (3; back) — 50 each

**Legs** (2) — 450 each

Reinforced Pilot's Compartment — 110

\* Main Body — 770

**Note:** The head and hands are small and difficult targets to hit. Thus, they can only be hit when a character makes a *called shot* and even then the attacker is at -3 to hit.

\* Depleting the M.D.C. of the main body will shut the armor down completely, rendering it useless. **Note:** Laser weapons do half damage!

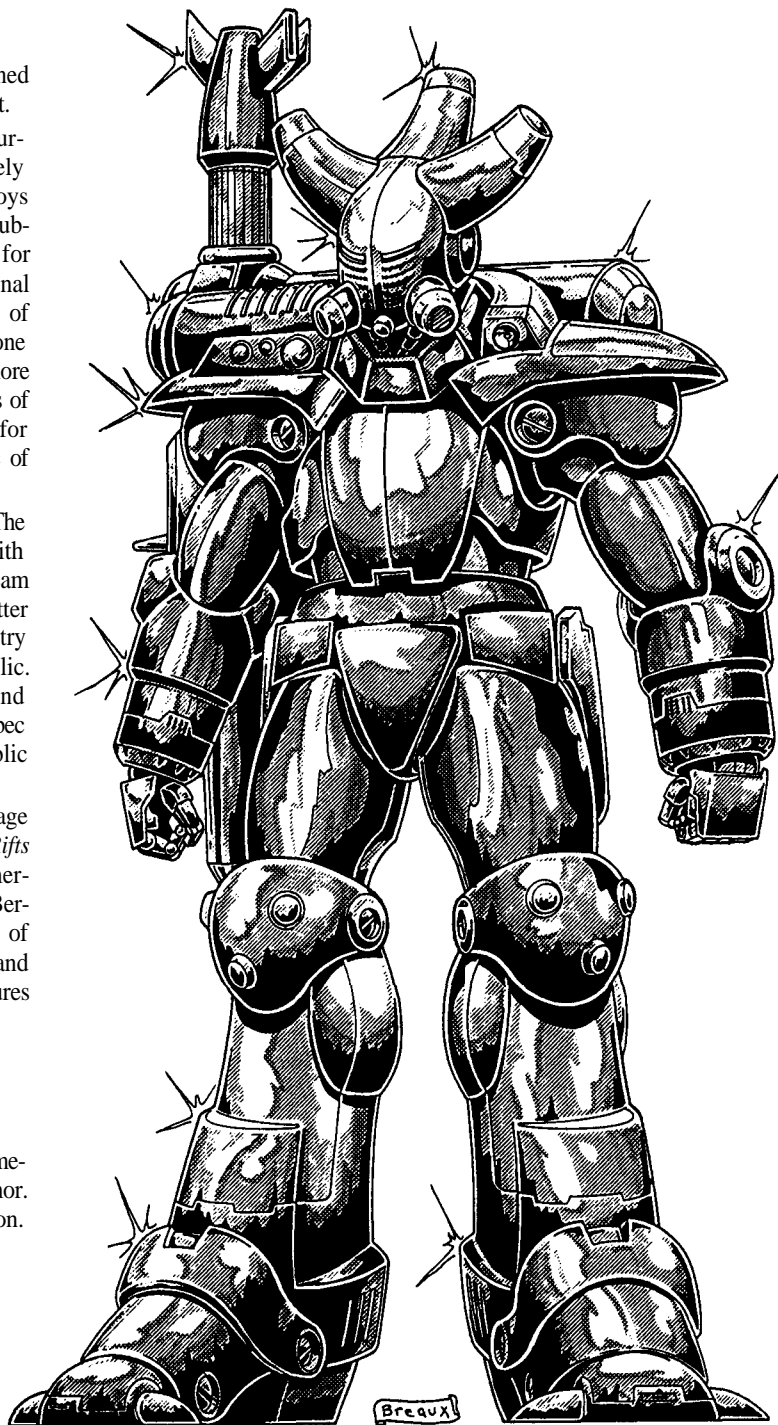

**Speed:**

**Running:** 60 mph (96 kmph) maximum

**Leaping:** The powerful robot legs can leap up to 12 feet (3.65 m) high or across. Add 10 feet (3.0 m) with a running start. Jet **thruster** assisted leaps can hurl the power armor 80 feet (24.4 m) up or across. If necessary, the thruster can momentarily hold the GB aloft as high as 12 feet (3.65 m) off the ground, but only for a short period of 1D6x10 seconds. The **thrusters** are not made for flying.

**Statistical Data:**

**Height:** 10 feet, 5 inches (3.1 m)

**Width:** 4 feet, 4 inches (1.3 m)

**Length:** 4 feet (1.2 m)

**Weight:** 1.2 tons fully loaded

**Physical Strength:** Equal to a P.S. 30.

**Cargo:** Minimal storage space; storage for a rifle, handgun, survival knife, first-aid kit and standard backpack.

Power System: Nuclear; average energy life is 25 years.

Market Cost: In North America, the Black Market cost is 25 million credits and up for a new, undamaged, fully powered Glitter Boy complete with boom gun. 15 million for a rebuilt or without gun. In Japan, the GB is used exclusively by the military of the Republic of Japan. Only a tiny handful of *rebuilt* or stolen Glitter Boys of any type, are found in the hands of criminals, rival kingdoms, meres or adventurers. Rarely available.

## Weapon Systems

**1. RG-14 (1):** The famous "Boom Gun" is a unique rail gun that can accelerate its **flechette** style rounds to a speed of Mach 2 and actually creates a sonic boom when fired. The weapon is the most powerful Pre-Rifts weapon to survive the Time of Rifts and has not yet been successfully duplicated or seen as a worthwhile item for duplication (other comparable weapons exist without the detriments of a sonic boom and shock waves to be overcome) except in Japan, Free Quebec and the NGR. The Boom Gun is attached to the back and right shoulder of the armor. When not in use, it is flipped back and stored in an upward position. When needed for combat, the GB's operator simply reaches back, grasps the handle and pulls forward. The blast is so powerful that without the automatic stabilization system (**thrusters** and pylons), the Glitter Boy would be thrown to the ground and knocked back 30 feet (9.1 m).

The automatic stabilization system is a synchronized system of jet **thrusters** and retractable reinforcement pylons in the legs that hold the armor steady. The pylons and the jets fly into action the moment the Boom Gun is fired.

Primary Purpose: Assault and Anti-Armor.

Secondary Purpose: Anti-Aircraft

Weight: Rail Gun: 867 pounds (390 kg)

Mega-Damage: One Boom Gun **Flechette** round holds 200 slugs that inflict 3D6x10 M.D.

Effects of the Sonic Boom: The GB suit is specially insulated from the shock waves of the Boom Gun, however, everybody within 200 feet (61.0 m) will be temporarily deafened. Characters without any type of head/ear protection will be temporarily deafened for 2D4 minutes and are -8 on initiative and -3 to parry and dodge. Characters who are in protective body or power armor will have some protection, but are still temporarily deafened for 1D4 minutes; same penalties apply. Each sonic boom adds to the duration of the deafness. The sonic boom will also affect the physical surroundings by shaking buildings and shattering S.D.C. windows within 300 feet (91.4 m) of the boom.

Rate of Fire: Equal to the number of combined hand to hand attacks of the pilot and his power armor (usually 4-6, see Power Armor Training). Bursts and sprays are not possible!

Maximum Effective Range: 11,000 feet (about two miles/3.2 km).

Payload: 100 rounds. Unlike some of the other power armor suits, the Glitter Boy's Boom Gun can be reloaded by hand, one round at a time, by the pilot. It will take about 15 minutes to load approximately 40 rounds. A carrying drum of 40 rounds is sometimes used to carry extra rounds. The drum has 30 M.D.C. and can attach to the hip/waist or left forearm.

**2. Hand to Hand Combat:** Rather than use a weapon, the pilot can engage in mega-damage hand to hand combat. See Power Armor Combat Training, pages 44 and 45, in the **Rifts RPG**.

Combat Bonuses: +1 on initiative, +1 to parry and dodge, and +3 to roll with punch, fall, or impact (very shock resilient). All bonuses are in addition to the normal Power Armor Training Bonuses.

**3. Sensor System:** The Glitter Boy has some special features.

**Thermo-Imager:** A special optical heat sensor that allows the infrared radiation of warm objects to be converted into a visible image. Enables the pilot to see in the dark, in shadows, and through smoke. Range: 2000 feet (610 m).

**Infrared and Ultraviolet Optics:** This optical system projects a beam of infrared light that is invisible to the normal eye. The infrared beam enables the pilot to see in the dark and to see other infrared beams. The ultraviolet system enables the pilot to see into the ultraviolet spectrum of light and is mostly used to detect the light beams of ultraviolet detection systems. **Note:** The infrared light beam *can* be seen by anybody who also has infrared optics, and the beam can be tracked back to its source. Smoke impairs the infrared beam, making it impossible to see.

Advanced Laser Targeting as well as the usual robot standard features. The Boom Gun is +2 to strike. See Power Armor Combat Training in the **Rifts RPG** for other bonuses and data.

---

## New Glitter Boys

---

Before the coming of the Rifts, the Glitter Boy robot was at the cutting edge of military technology. Equipped with the armor, a single pilot could become the equal of a company or more of conventional soldiers. Despite its successes, the Glitter Boy is not without its weaknesses. Even the devastating "Boom Gun" rail cannon has severe disadvantages. For one, the sonic boom of its gun makes the use of the suit dangerous, even crippling to unprotected soldiers and civilians, causing deafness and trauma. The sonic boom also shatters windows and glass that can become flying shrapnel that is deadly to unprotected soldiers and civilians, as well as contributing to additional property damage. The weapon can also cause problems for GBs that aren't properly secured.

Despite the heavy armor plating and devastating "Boom Gun," the robot was vulnerable to hit and run **guerrilla-style** tactics due to its poor mobility and the pylon anchor system. To fire the rail gun, the bot was forced to entrench itself in a fixed position, allowing concealed infantry units to sneak around to fire on its flanks. This was especially true in forest, jungle and urban settings (the power armor is ideal for desert, plains and open warfare).

Another problem was concealment. Hiding the ten foot (3.0 m) glittering chrome bulk of the Glitter Boy is impossible. Unless the unit was parachuted into action or moving into attack at high speed, the element of surprise was impossible to achieve. More likely than not, the robotic titan would be spotted miles away, giving enemy forces time to prepare for an assault or retreat. What's more, the Glitter Boy was an easy target for air strikes, spotted easily from the air. Although many of these problems could be offset by combining the G10 with other types of bots and armor (like the new SAMAS), it was decided to try to improve the Glitter Boy itself. The strengths of the original design far outweighed the disadvantages, so nobody wanted to scrap the one-man juggernaut.

Consequently, just prior to the Great Cataclysm, a number of new weapon configurations for the robot and power armor variants were being developed. ArmaTech's success with the SAMAS won them the contract to improve and modify the G10. These variants can be found only in Japan.

---

## "Point" Glitter Boy

---

The first of these variants was the USA-G10A1 "Point," basically a scaled down Glitter Boy armed with lighter weaponry. As a medium between the infantryman and the G10, the Point could be used with regular grunts or units of Glitter Boys.

The main aspect for which the Point was designed was that of reconnaissance. With its camouflage paint job, smaller size, speed and maneuverability, the armor makes a reasonably good scout for larger Glitter Boy units. Reports concerning enemy strength, troop movements or terrain features from the smaller Glitter Boy enables the regulars to operate at higher efficiency. It can also be used to "feel out" enemy units, discover ambushes, locate booby-traps or engage in seek and destroy missions. The camouflage paint is an S.D.C. substance, so attacks, especially from M.D. weapons, would quickly remove most of it to reveal the laser resistant chrome of the **G10A1**, restoring its advantage against lasers.

The Boom Gun has been replaced with a heavy, shoulder-mounted laser cannon and rocket launcher. The laser is silent and offers good range. Without the Boom Gun, the Point has the advantage of not requiring a stabilization system to use its weapons. This has made it possible to make the G10A1 smaller and to use the thrusters for greater mobility, longer jet assisted leaps and greater time in a hover mode. Flight is still not a possibility.

**Model Type:** USA-G10A1

**Class:** Laser Resistant Armored Infantry Personnel Reconnaissance Unit

**Crew:** One pilot

**M.D.C. by Location:**

Head — 190

Arms (2) — 190 each

Hands (2) — 60 each

**M-BiLAR-5000** (1; behind left shoulder) — 100

**AT-200 Rail Gun** (1; left forearm) — 50

Rail Gun Ammo Drum (1; behind left shoulder) — 35

Smoke Grenade Dispensers (2) — 15

Stabilizing Thrusters (3; back) — 50 each

Legs (2) — 325 each

Reinforced Pilot's Compartment — 100

Closed Circuit Camera — 4

\* Main Body — 480

**Note:** The head and hands are small and difficult targets to hit. Thus, they can only be hit when a character makes a *called shot* and even then the attacker is at -3 to hit.

\* Depleting the M.D.C. of the main body will shut the robot down completely, rendering it useless. **Note:** Laser weapons do half damage!

**Speed:**

**Running:** 90 mph (145 kmph) maximum.

**Leaping:** The powerful robot legs can leap up to 15 feet (4.6 m) high or across. Add 15 feet (4.6 m) for a running start. Jet **thruster** assisted leaps can hurl the power armor 100 feet (30.5 m) high or lengthwise. If necessary, the thruster can momentarily hold the GB aloft as high as 100 feet (30.5 m) off the ground, but only for about four minutes. The thrusters are not made for flying.

**Statistical Data:**

**Height:** 7 feet, 10 inches (2.4 m)

**Width:** 3 feet, 10 inches (1.15 m)

**Length:** 3 feet, 8 inches (1.1 m)

**Weight:** 1 ton fully loaded.

**Physical Strength:** Equal to a P.S. 30

**Cargo:** Minimal storage space; storage for a rifle, handgun, survival knife, and first aid kit.

**Power System:** Nuclear; average energy life is 25 years.

**Black Market Cost:** The Point Glitter Boy is used exclusively by the military of the Republic of Japan. Only a tiny handful of *rebuilt* or stolen Glitter Boys of any type, are found in the hands of criminals, rival kingdoms, meres or adventurers. Very rare.

## Weapon Systems

**1. Multi-Barrel Laser Rifle (M-BiLAR) AT-5000:** The M-BiLAR was developed to give the "Point" robot a lightweight but devastating main gun. The M-BiLAR is slung on the back of the Point GB and used much the same way as the traditional Boom Gun. This is a devastating weapon because it has five separate laser barrels arranged in a circular pattern at the muzzle of the rifle/cannon. Two, four or five can be fired simultaneously for varying degrees of damage. The weapon is long-range, silent and does not have the deafening or damaging side-effects of the old Boom Gun. Through **nano-technology**, the M-BiLAR is surprisingly compact and lightweight, especially when one considers the level of damage it can impart against opponents.

**Primary Purpose:** Assault

**Secondary Purpose:** Anti-Armor and Anti-Aircraft.

**Weight:** 289 pounds (131 kg)

**Mega-Damage:** 4D6 M.D. per double blast, 1D4×10+8 M.D. per quadruple blast and 1D6×10 M.D. per full strength, five barrel laser pulse.

**Rate of Fire:** Equal to the combined number of hand to hand attacks (usually 4-6).

**Maximum Effective Range:** 6000 feet (1830 m)

**Payload:** Effectively unlimited; the M-BiLAR is tied directly into the robot's nuclear power supply.

**Advanced Laser Targeting** as well as the usual power armor standard features. The M-BiLAR has an advanced laser targeting system that makes it +2 to strike for aimed shots (only). See Power Armor Combat Training in the **Rifts RPG** for other PA bonuses and data.

**2. AT-200 III Rail Gun** (1): A miniature, **tri-barrelled** rail gun is mounted on the left forearm of the Point robot. It fires standard rail gun ammunition rather than the bulky **flechette** rounds of the famous "Boom Gun." The weapon is far less powerful than the **RG-14** but still packs quite a punch for its small size. Additionally, the AT-200 has rapid fire capabilities, it is light and has deadly accuracy.

**Primary Purpose:** Anti-Personnel

**Secondary Purpose:** Assault

**Weight:** Rail Gun: 68 pounds (31 kg)

**Mega-Damage:** A full damage burst from all three barrels is 30 rounds and inflicts 6D6 M.D. The pilot can opt to fire a shorter burst of 15 shots which inflicts 3D6 M.D.

**Rate of Fire:** Equal to the number of combined hand to hand attacks of the pilot and his power armor (usually 4-6, see Power Armor Training).

**Maximum Effective Range:** 3000 feet (914 m)

**Payload:** 3300 rounds, that's 110 full strength bursts, contained in an internal feed drum magazine. Reloading takes about 5 minutes but requires trained technicians with specialized equipment. Loading in a combat setting is impossible because of the required equipment and personnel.

**3. Smoke Dispensers** (2): Each of the large robot legs have a pair of small grenade launchers that fire smoke dispensing grenades. The smoke is released to conceal the robot and mask its escape.

**Mega-Damage:** None, serves as concealment or a distraction. The smoke screen covers a roughly circular area with a diameter of 80 feet (24.4 m).

**Rate of Fire:** 1, 2, 3 or 4 at a time.

**Maximum Effective Range:** 80 feet (24.4 m)

**Payload:** 4 smoke grenades total; 2 in each leg.

**4. Hand to Hand Combat:** Rather than use a weapon, the pilot can engage in mega-damage hand to hand combat. See Power Armor Combat Training, pages 44 and 45, in the **Rifts RPG** for specifics.

**Combat Bonuses:** +1 on initiative, +2 to roll with punch or impact



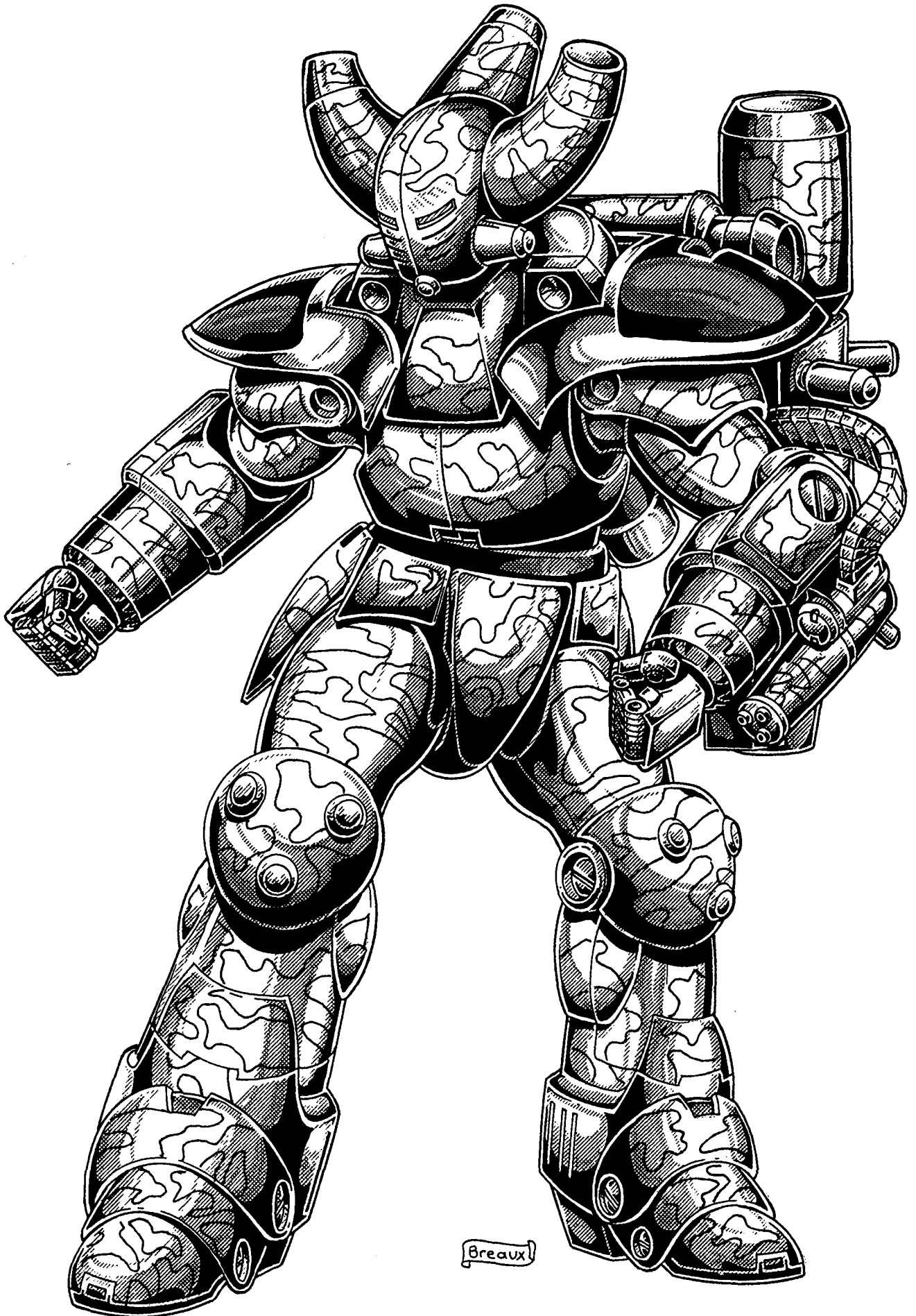

(shock resistant), and no prowl penalty except when camouflage paint is removed (-15%). All bonuses are in addition to the normal Power Armor Training Bonuses.

**5. Sensor Systems:** The Glitter Boy has all the standard power armor features plus:

Passive Nightvision Optics: Amplified light system; 2000 foot (610 m) range.

Infrared and Ultraviolet Optics: This optical system projects a beam of infrared light that is invisible to the normal eye. The infrared beam enables the pilot to see in the dark and to see other infrared beams. The ultraviolet system enables the pilot to see into the ultraviolet spectrum of light and is mostly used to detect the light beams of ultraviolet detection systems. **Note:** The infrared light beam *can* be seen by anybody who also has infrared optics, and the beam can be tracked back to its source. Smoke impairs the infrared beam, making it impossible to see.

Molecular Analyzer: Basically the same as the bionic lung implant. It is a small, computerized mechanism built into the armor and combat data system that can recognize and identify strong chemical signatures in the air, including napalm, toxic gases, strong pollution, smoke/fire, petroleum fumes (oil, gasoline, kerosene, paint, etc.), and even some explosives (mainly plastique and gelatin types). It cannot recognize the scent of specific people or animals.

Closed Circuit Camera: There is a small, closed circuit camera attached over the barrel of the **M-BiLAR-5000** (which may appear to be a targeting sight) **and/or** mounted on the left shoulder; some pilots prefer to wear two cameras. This is a camera which relays and/or records everything seen by the Point Glitter Boy to a mobile Command unit or base outpost. As a result, even if crippled, the reconnaissance pilot has performed his task in relaying data. It also enables Command to dispatch reinforcements, aerial support or extraction teams the second the Point gets into trouble that is beyond its capabilities to escape. Up to 12 hours of video can be recorded.

---

## “Hawkeye” Glitter Boy

---

Glitter Boys whether alone or in units are extremely vulnerable to aircraft, flying power armor and airborne enemies of all kinds. The Glitter Boy's "Boom Gun" poses no threat to bombers and fighter aircraft flying at high altitudes, and even low-flying but fast moving aerial opponents can easily **outmaneuver** the comparatively slow power armor — don't forget that the GB must anchor itself in one place to fire the Boom Gun effectively. Since the GBs are used in place of traditional tanks and armored vehicles, it was decided to create a Glitter Boy with anti-aircraft capabilities, as well as combining the GB with flying defenders like the SAMAS to counter airborne enemies. So it was that the G10A2 Hawkeye came into being.

Using the same basic body as the G10 but fitted with different armaments, the Hawkeye is essentially, a mobile surface to air missile battery. Regular Glitter Boy robots can assault the enemy with virtual impunity while the Hawkeye engages flying opponents. Unlike its counterparts, however, the Hawkeye does not require the use of a pylon system and can maneuver to engage airborne opponents approaching from any direction.

The Hawkeye Glitter Boy is also an effective weapon against armored ground troops, dragons and supernatural menaces. Glitter Boy squads in the Republic of Japan include at least one Hawkeye but often as many as three will be included on missions expecting heavy aircraft contact.

**Model Type:** USA-G10A2

**Class:** Laser Resistant Armored Infantry Personnel Anti-Air Unit

**Crew:** One pilot

**M.D.C. by Location:**

M-BiLAR Laser Gun (1; right shoulder) — 100

GMS-24 Missile Launcher (1; back) — 250

GMS-SAM Mini-Missile Launcher (1; left shoulder) — 55

Forearm Mini-Missile Launchers (2) — 25 each

Head — 290

Arms (2) — 270 each

Hands (2) — 100 each

Legs (2) — 450 each

Reinforced Pilot's **Compartment** — 110

\* Main Body — 770

Note: The head and hands are small and difficult targets to hit. Thus, they can only be hit when a character makes a called shot and even then the attacker is at -3 to hit.

\* Depleting the M.D.C. of the main body will shut the robot down completely, rendering it useless. **Note:** Laser weapons do half damage!

**Speed:**

Running: 60 mph (96 kmph) maximum

Leaping: The inclusion of missile and long-range weapons prevents the G10A2 from performing leaps. Likewise, the **thruster** stabilization system on its back has been replaced with missile launchers and an additional power supply.

**Statistical Data:**

Height: 10 feet, 5 inches (3.1 m)

Width: 4 feet, 4 inches (1.3 m)

Length: 4 feet (1.2 m)

Weight: 1.2 tons fully loaded

Physical Strength: Equal to a P.S. 30

Cargo: Minimal storage space; storage for a rifle, handgun, survival knife, first-aid kit and standard backpack.

Power System: Nuclear; average energy life is 25 years.

Black Market Cost: The Hawkeye Glitter Boy is used exclusively by the military of the Republic of Japan. Only a tiny handful of *rebuilt* or stolen Glitter Boys of any type, are found in the hands of criminals, rival kingdoms, meres or adventurers. Extremely rare.

## Weapon Systems

**1. Multi-Barrel Laser Rifle (M-BiLAR) AT-5000:** The same lightweight but devastating main gun as used by the Point GB. This weapon has no "kick" and allows for maximum **maneuverability**.

Primary Purpose: Anti-Armor and **Anti-Aircraft**.

Secondary Purpose: Assault

Weight: 289 pounds (131 kg)

Mega-Damage: 4D6 M.D. per double blast, **1D4×10+8M.D.** per quadruple blast and **1D6×10 M.D.** per full strength, five barrel laser pulse.

Rate of Fire: Equal to the combined number of hand to hand attacks (usually 4-6).

Maximum Effective Range: 6000 feet (1830 m)

Payload: Effectively unlimited; the M-BiLAR is tied directly into the robot's nuclear power supply.

Advanced Laser Targeting as well as the usual power armor standard features. The M-BiLAR has an advanced laser targeting system that makes it +2 to strike for aimed shots (only). See Power Armor Combat Training in the **Rifts RPG** for other PA bonuses and data.

**2. GMS-24 Medium-Range Missile Launcher:** The traditional ammunition and stabilizer jets have been replaced by a large, back missile launcher that fires unusually small medium-range missiles. The smaller missiles replace the more archaic and inferior missiles used



by the CS and most North American nations. Their range is a bit more limited but are ideal for anti-aircraft purposes and allow for a greater payload; a product of pre-Rifts advances and nano-technology.

Primary Purpose: Anti-Aircraft

Secondary Purpose: Assault

Missile Type & Mega-Damage: GMS-24 medium range-missiles

Types are limited to the following (all are smart bombs, +5 to strike):

High Explosive: 2D6x10 M.D.

Plasma/Heat: 3D6x10 M.D.

Fusion: 4D6x10M.D.

Rate of Fire: One at a time, or volleys of two or four.

Maximum Effective Range: 21 miles (33.7 kg) for each missile type.

Payload: 24 total.

**3. GMS-SAM Launcher (1):** A box-style mini-missile launcher is attached to the left shoulder of the armor. It contains heat-seeking mini-missiles used against low flying enemy targets. The pilot can launch mini-missiles by voice command or with the press of a trigger mechanism.

Primary Purpose: Anti-Aircraft

Secondary Purpose: Assault

Missile Type: Any mini-missile type can be used but standard issue are armor piercing (1D4x10 M.D.) or plasma missiles (1D6x10M.D.).

Mega-Damage: Varies with missile type.

Rate of Fire: One at a time, or volleys of two, four and six.

Maximum Effective Range: Varies with missile type.

Payload: 24 total.

**4. GMS-FAM Launcher (2):** Built into each forearm are a pair of mini-missile launchers. The pilot needs only to point and fire.

Primary Purpose: Anti-Aircraft

Secondary Purpose: Defense

Missile Type: Any mini-missile type can be used but standard issue are

armor piercing (1D4x10 M.D.), plasma missiles (1D6x10 M.D.) or AAD-Dissolvers (anti-armor).

Mega-Damage: Varies with missile type.

Rate of Fire: One at a time, or volleys of two, four and six.

Maximum Effective Range: Varies with missile type.

Payload: Six total; three per arm.

**5. Hand to Hand Combat:** Rather than use a weapon, the pilot can engage in mega-damage hand to hand combat. See Power Armor Combat Training, pages 44 and 45, in the **Rifts RPG**.

Special Combat Bonuses: +3 on initiative due to extended radar, +1 to roll with punch, fall, or impact (very shock resilient). All bonuses are in addition to the normal Power Armor Training Bonuses.

**6. Sensor System:** The Glitter Boy has all the standard power armor features plus:

Advanced Radar System: This radar system can track up to 200 targets simultaneously, with a range of 50 miles (80 km).

Radar Jamming System: This radar jamming system is capable of interfering with all radar within a 5 mile (8 km) radius! Systems affected will see their range, tracking capacity and all other capabilities reduced by half. In addition, the images are blurred, ghosted and generally unreliable; -50% to read sensory instrument skill. Unfortunately, the use of the jamming system has the same effect on the Glitter Boy and those around it.

## Optional GB Weapon Systems

Any of the Glitter Boys can have its standard, main gun replaced with one of the following weapons. This is typically done to accommodate the needs of special circumstances, environments and assignments:

1. **AT-1800** Ail-Purpose Rail Gun: A rapid-fire rail gun designed to engage low flying enemy and armored troops. The three long barrels of the gun makes it **longer/larger** than the Boom Gun and it has an amazing ammunition capacity. The main advantage is that it does not have the jolting kick or sonic blast of the heavier gun, making it better for urban combat and some infantry situations. However, it has a shorter range and inflicts less damage.

Primary Purpose: Anti-Armor and Anti-Aircraft.

Secondary Purpose: Assault

Weight: 475 pounds (215 kg)

Mega-Damage: A burst is 50 rounds and inflicts 1D6x10+10M.D.

Rate of Fire: Equal to the combined number of hand to hand attacks (usually 4-6).

Maximum Effective Range: 6,000 feet (1828 m).

Payload: 9000 rounds, that's 180 bursts! Reloading a drum will take about 5 minutes for those not trained, but a mere one minute by somebody trained in the use of power armor; a strength of 26 or higher is required.

2. Underwater M-BiLAR **AT-5500:** An underwater version of the M-BiLAR 5000. It uses blue-green light beams and is deployed for underwater operations by the **G10** and **G10A1**.

Primary Purpose: Assault

Secondary Purpose: Anti-Armor and Anti-Aircraft.

Weight: 289 pounds (131 kg)

Mega-Damage: 4D6 M.D. per double blast, 1D4x10+8 M.D. per quadruple blast and 1D6x10M.D. per full strength, five barrel laser pulse.

Rate of Fire: Equal to the combined number of hand to hand attacks (usually 4-6).

Maximum Effective Range: Underwater 2200 feet (670.5 m) or 5000 feet (1520 m) in an atmosphere.

Payload: Effectively unlimited; the M-BiLAR is tied directly into the robot's nuclear power supply.

Advanced Laser Targeting as well as the usual power armor standard features. The M-BiLAR has an advanced laser targeting system that makes it +2 to strike for aimed shots (only). See Power Armor Combat Training in the Rifts RPG for other PA bonuses and data.

3. **GMS-APM Launcher:** A mini-missile launcher with 12 missile slots, is mounted above and behind the right shoulder in place of the main gun. If all the missiles have been fired or the launcher is damaged it can be jettisoned. A small explosive charge propels the unit away from the armor. Usually the pilot will only detach the launchers if necessary since they can be reloaded normally.

Primary Purpose: Anti-Personnel and Anti-Armor.

Secondary Purpose: Anti-Aircraft.

Missile Type: Any type of mini-missile can be used, but standard issue are fragmentation (5D6 M.D.), or stun and smoke for riot control.

Mega-Damage: Varies with missile type.

Maximum Effective Range: Usually about one mile (1.6 km).

Rate of Fire: One at a time, or volleys of two, four, six or 12.

Payload: 48 per launcher. Reloading takes 1D4+2 minutes.

Note: The Glitter Boy can also carry and use most hand held weapons designed for cyborgs and robots. A particle beam weapon has not been specifically devised for the Glitter Boy because the GB is considered a heavy armor with long-range weapon capabilities (6000 feet/1830 or greater) and even the most advanced **P-beam** cannon can barely reach 3000 feet (914 m).

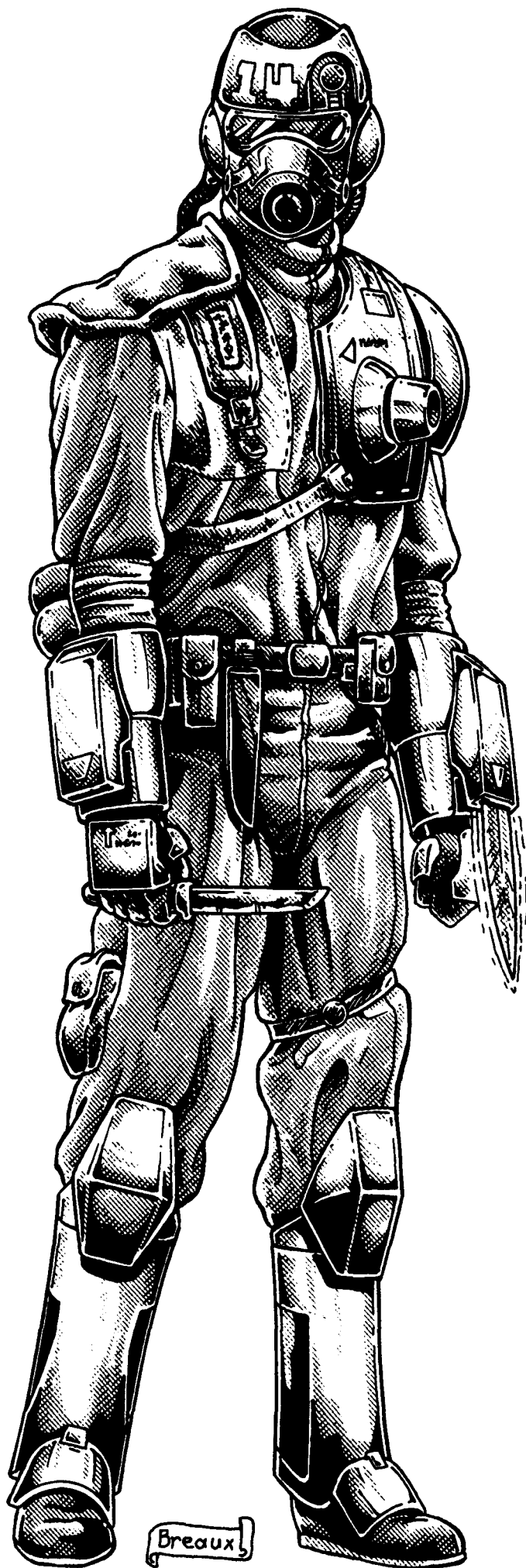

## ATPA-85 "Power-Spy"

The ATPA-85 is the lightest power armor suit in the Republic of Japan's mechanized infantry force. Developed by **ArmaTech** for stealth rather than heavy combat, the Power-Spy is very much a lightweight *exoskeleton* meant to augment the human wearer rather than encase him in armor. The fiber of the environmental covering may appear to be cloth but is a metal and ceramic mesh created through molecular bonding and is 100 times stronger than steel. **Nano-systems** are linked to tiny implants in the wearer's body for maximum response to muscle movement and electrical impulses from the body. An Intel medi-unit is connected to the wearer to monitor his or her physical condition and responds to injury instantly with painkillers, antibiotics, adrenaline, RMK "knitter" surgical **nano-bots**, and **IRMSS** internal (nano) robot medical surgeon system. The Power-Spy armor has earned an excellent reputation and is the favorite armor of reconnaissance troops, spies, saboteurs, assassins and espionage agents.

As with all power armor suits, the ATPA-85 exoskeleton boosts the pilot's natural strength, speed and endurance. A portable jet pack can be worn to provide the wearer with flight capabilities. The Power-Spy provides more mega-damage protection than body armor, although less than the average power armor. The armor is fairly sturdy, reliable, fairly inexpensive and even has a few minor weapon systems built-in. Standard color is black with some minor, dark blue, green or grey highlights.

**Model Type:** ATPA-85 Power-Spy

**Class:** Stealth Combat Power Armor/Exoskeleton

**Crew:** One

**M.D.C. by Location:**

Arms (2) — 30 each

Legs (2) — 60 each

Chest Ion Gun — 30

Forearm **Vibro-Blades** (2) — 25 each

\* **Head/Helmet** — 60

\*\* **Main Body** — 110

\* Destroying the head of the power armor will eliminate all forms of optical enhancement and sensory systems. The pilot must rely on his own human vision and senses. Any power armor bonuses to strike, parry and dodge are lost! **Note:** The head is a small and difficult target to hit. Thus, it can only be hit when a character makes a called shot, but even then the attacker is -3 to strike.

\*\* Depleting the M.D.C. of the main body will shut the armor down completely, rendering it useless.

**Speed:**

**Running:** Adds 20 points to the wearer's natural Spd attribute and the act of running and exertion tires its operator at 20% of the usual fatigue rate thanks to the robot exoskeleton.

**Leaping:** The augmentation of the exoskeleton enables the wearer to jump up to 20 feet (6.1 m) straight up or lengthwise from a standing still position.

**Flying:** The Power-Spy does not have flying capability but has been designed for easy attachment of a jet pack of almost any variety. Most standard models can fly at a maximum speed of **180 mph** (288 kmph), have a maximum altitude of about 4000 feet (122 m) and a fuel capacity of one hour. Many can patch into the power supply of the armor for indefinite flight.

**Statistical Data:**

**Height:** About 6 inches (0.15 m) larger than the wearer.

**Width:** Form fitting; about 6 inches (0.15 m) larger than the wearer.

**Length:** Form fitting; about 6 inches (0.15 m) larger than the wearer. Add another two feet (0.6 m) for a jet pack.

**Weight:** 90 lbs (40.8 kg)

Physical Strength: Equal to a P.S. of 22.

Cargo: None.

Power System: Nuclear, with an average energy life of 10 years.

Market Price: 450,000 credits for an undamaged, fully powered suit. Exclusive to the Armed Forces of the Republic of Japan, although a handful have made it to the Black Market and some secret and criminal organizations. Availability, even on the Black Market, is terrible.

Note: Both **Ichto** and H-Brand make an inferior, heavier, bulkier *version* that costs around 370,000 credits — add 90 pounds (40.8 kg), shoulder, leg, and forearm plates, and increase M.D.C. by 20%, however reduce speed, leaping distance, and P.S. by 10%, and the armor has a prowl penalty of -15%; all weapons are the same as the Power-Spy.

## Weapon Systems

**1. AT-85 Ion Gun:** A stubby ion blaster, hooked to the nuclear power supply of the suit, is mounted in the center of the chest. The stubby barrel can rotate 45 degrees in all directions.

Primary Purpose: Defense

Mega-Damage: 4D6 M.D. per blast

Maximum Effective Range: 800 feet (244 m)

Rate of Fire: Equal to the number of combined hand to hand attacks (usually 4-6).

Payload: Effectively unlimited.

**2. Vibro-Blades (2):** Long, retractable vibro-swords are built into both forearms.

Mega-Damage: 2D6 M.D.

Bonuses: +1 to strike and +2 to parry.

**3. Energy Rifles, Rail Guns** or other hand weapons can be used easily by the man-sized power armor. Officers will also wear a pistol or other **sidearm**.

**4. Hand to Hand Combat:** Rather than using a weapon, the pilot can engage in mega-damage hand to hand combat. See Basic and Elite Power Armor Combat Training in the **Rifts RPG**, page 45. All abilities are the same except as follows:

Normal Punch — 1D4 M.D.

Power Punch — 2D4 M.D., but counts as two attacks.

Leap Kick — 2D6 M.D.

An additional +1 to dodge and roll at level **five**.

+2 to pull punch.

No power armor prowl penalty.

---

# H-Brand “Ninjabot”

---

The H-Brand Ninjabot is a heavy-duty, mass market power armor intended as another method to capture the attention of those fascinated by the mystic ninja and the **ArmaTech** Power-Spy. Other than its **name**, ion chest gun, the power armor's black color and Japanese styling, it has nothing in common with the Power-Spy, ninja or stealth. It is made of a lightweight metal and ceramic plating and is a full environmental suit with an attachment for an optional jet pack.

Real "mystic" ninjas avoid most technological trappings, relying on mystic powers, training and magic, while ninja juicers, tech-ninja and espionage or military specialists would rarely use the cumbersome Ninjabot armor. However, it is popular among adventurers, street punks, bandits and some mercenaries; mainly inexperienced folk who are suckered by the name and sales-pitch.

**Model Type:** H-Brand Ninjabot

**Class:** Stealth Combat Power Armor

**Crew:** One

**M.D.C. by Location:**

Arms (2) — 40 each

Legs (2) — 80 each

Ion Chest Gun (1) — 30

Forearm **Vibro-Blade** (1; right) — 20

Mini-Missile Tube Launchers (6; left shoulder) — 20 each

\* Head — 75

\*\* Main Body — 190

\* Destroying the head of the power armor will eliminate all forms of optical enhancement and sensory systems. The pilot must rely on his own human vision and senses. Any power armor bonuses to strike, parry and dodge are lost! **Note:** The head is a small and difficult target to hit. Thus, it can only be hit when a character makes a called shot, but even then the attacker is -3 to strike.

\*\* Depleting the M.D.C. of the main body will shut the armor down completely, rendering it useless.

**Speed:**

Running: 50 **mph** (80 **kmph**) maximum. Note the act of running does tire its operator, but at 30% of the usual fatigue rate.

Leaping: 10 feet (3.0 m) straight up or lengthwise from a short running start.

Flying: No flying capability but has been designed for easy attachment of a jet pack.

**Statistical Data:**

Height: 7 feet, 5 inches (2.2 m)

Width: 3 feet, 6 inches (1 m)

Length: 2.5 feet (0.75 m)

Weight: 240 **lbs** (108 **kg**)

Physical Strength: Equal to a P.S. of 25.

Cargo: None.

Power System: Nuclear, with an average energy life of 15 years.

Market Price: 1 million credits for a brand new, undamaged suit with fully loaded weapon systems. Fair to good availability. This power armor is illegal in the Republic of Japan and is available only from criminal organizations, usually at 15% above the normal price; poor availability.

## Weapon Systems

**1. H-85 Ion Gun:** A stubby ion blaster, hooked to the nuclear power supply of the suit, is mounted in the center of the armor's chest. The barrel can rotate 45 degrees in all directions. A cheap imitation of the Power-Spy ion gun.

Primary Purpose: Defense

Mega-Damage: 4D6 M.D. per blast.

Maximum Effective Range: 800 feet (244 m)

Rate of Fire: Equal to the number of combined hand to hand attacks (usually 4-6).

Payload: Effectively unlimited.

**2. Vibro-Blade (1):** A retractable vibro-sword is built into the right forearm.

Mega-Damage: 2D6 M.D.

Bonuses: +1 to strike and +2 to parry.

**3. Mini-Missile Tube Launchers (6):** Six tube launchers are built into the oversized plate enclosing the left shoulder. Each contains one mini-missile

Primary Purpose: Assault

Secondary Defense: Defense

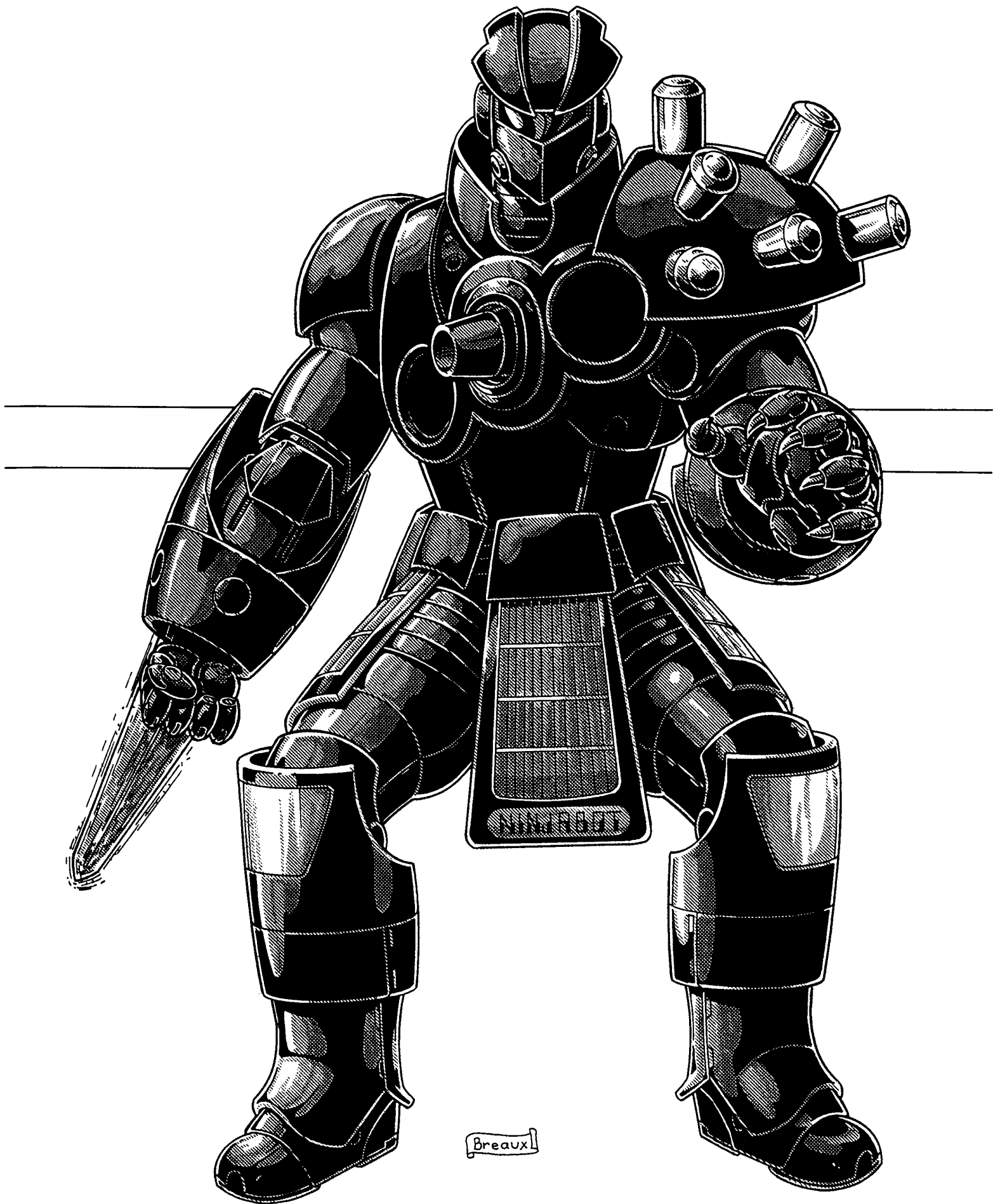



Mega-Damage: Varies with missile type, usually 1D4×10 M.D. or 1D6×10 M.D.

Range: One mile (1.6 km).

Rate of Fire: One at a time, or in volleys of two.

Payload: Six total.

**4. Energy Rifles, Rail Guns** or other hand weapons can be used by the power armor. Weapons vary depending on the pilot's tastes, although vibro-swords and energy rifles are the most common.

**5. Hand to Hand Combat:** Rather than using a weapon, the pilot can engage in mega-damage hand to hand combat. See Basic and Elite Power Armor Combat Training in the **Rifts RPG**, page 45. All abilities are the same except as follows:

An additional +1 to parry.

+1 to pull punch

+1D6 M.D. to slashing and tearing attacks due to retractable claws on the fingers of each hand.

**6. Special features:** Has all the standard power armor features plus the following:

Retractable finger claws (see hand to hand for damage).

A grappling hook and towline can be fired out of a concealed housing in the left forearm. Similar to the *climb cord* bionic system, only the length of the cord is 150 feet (46 m).

Electro-adhesive pads are built into the hands and feet of the power armor. Activated by voice command, these pads allow the suit to climb sheer surfaces containing metal, such as office buildings, robots, etc.

Self-destruct: To prevent the suit from falling into enemy hands, there is a self-destruct mechanism. The suit monitors the pilot's life signs and will detonate when the operator is killed. Detonation can also occur as a result of voice command. When the suit explodes, the blast automatically destroys the power armor but is also channelled outward, causing 4D6×10 M.D. (add 1D4×10 M.D. for every mini-missile) in a 60 foot (18.3 m) radius.

---

# Ichto Power Armor & Robots

---

## IPA-40 Dai-Katana Bugei

In the test runs the IPA-40 prototype proved itself to be everything the design team had hoped for, and more. Ichto accomplished their goal of creating a small but tough armor suit capable of reaching high speeds, delivering heavy **firepower** and augmenting the operator's strength and reflexes. The IPA-40's agility has proven to be a great advantage in combat. A rough translation of Dai-Katana Bugei means "Great Sword Soldier."

It has become the standard power armor suit of the Ichto Armed Forces. As technology improves, Ichto just refits the armor rather than scrapping the combat-proven suit. Over the years, numerous improvements have been made, from the inclusion of a variable frequency laser, to mini-missile launchers, to a forearm **vibro-blade**.

Only slightly larger than man-sized but capable of reaching running speeds in excess of 100 mph (160 kmph), the Dai-Katana Bugei is an extremely versatile power armor. It is perfect for hit and run combat operations, espionage, anti-terrorism and frontline combat. Hovering capabilities and limited flight are provided by a built-in jet pack. The standard colors of the armor are black and grey or dark blue and grey. Ichto's Armed Forces use black and red colors (the red having a flame pattern), while **Otomo** uses dark purple and gold for its military.

**Model Type:** IPA-40 Power Armor

**Class:** Military Assault Exoskeleton

**Crew:** One

**M.D.C. by Location:**

Arms (2) — 90 each

Legs (2) — 140 each

Forearm Blades (2) — 20 each

Shoulder Missile Launchers (2) — 50 each

Rail Gun — 100

**Vibro-Blades** — 20 each

Ammo Drum — 75

Jet Pack — 60

\* Head — 75

\*\* Main Body — 250

\* Destroying the head of the power armor will eliminate all forms of optical enhancement and sensory systems. The pilot must rely on his own human vision and senses. Any power armor bonuses to strike, parry and dodge are lost!

The head (as well as the forearm blades, rail gun, and vibro-blades) is a small and difficult target to hit (shielded by mini-missile launchers). Thus, it can only be hit when a character makes a called shot, but even then the attacker is -4 to strike.

\*\* Depleting the M.D.C. of the main body will shut the armor down completely, rendering it useless.

### Speed:

**Running:** 100 mph (160 kmph) maximum. Note that the act of running does tire out its operator, but at 20% of the usual fatigue rate thanks to the robot exoskeleton.

**Leaping:** The powerful robot legs can leap up to 15 feet (4.5 m) high or lengthwise unassisted by the jet pack. A jet pack assisted leap propels the unit up to 80 feet (24.4 m) high and 100 feet (30.5 m) lengthwise without actually flying.

**Flying:** The rocket propulsion system allows enables the IPA-40 to hover stationary up to 200 feet (61.0 m) or fly. Maximum flying speed is 200 mph (320 kmph), but cruising speed is considered to be around 60 mph (96 kmph). Maximum altitude is limited to about 5000 feet (152m).

**Flying Range:** The nuclear power supply of the jet pack has five years of life, but the jet rockets get hot and need to cool after a maximum of five hours of continuous flight. If the pilot continues to push the jets after the five hour limit, it is likely (01-45% chance) that the jet pack will burn out. A burn out will damage the internal circuitry, rendering the pack useless and the **Katana** will be unable to fly until a new unit is installed.

### Statistical Data:

**Height:** 6 feet, 10 inches tall (2.1 m)

**Width:** 3 feet, 7 inches (1.08 m)

**Length:** 3 feet (0.9 m)

**Weight:** 395 lbs (179 kg)

**Physical Strength:** Equal to a P.S. of 30

**Cargo:** None

**Power System:** Nuclear; average energy life is 13 years.

**Market Price:** 2 million credits for a brand new, undamaged suit with fully loaded weapon systems. The suit is fairly available, and in wide

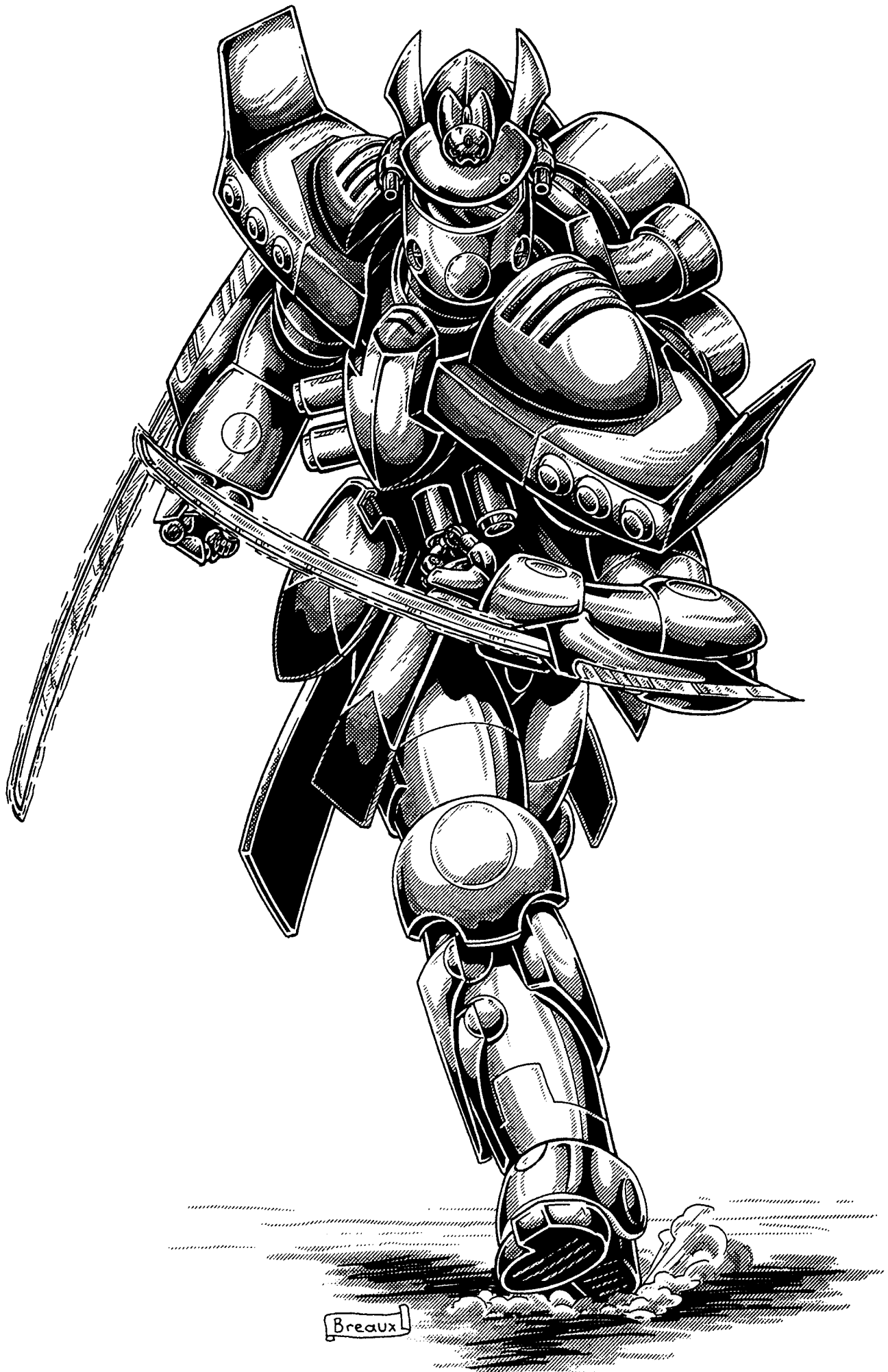

use among the troops in the Ichto and Otomo Shogunates as well as among mercenaries and adventurers. Each year a number of suits "go missing" from military installations. The Dai-Katana Bugei is illegal in the Republic of Japan and is available only from criminal organizations, usually at 25% above the normal price; poor availability.

## Weapon Systems

**1. IR-60 Rail Gun:** The Kantana's standard armament is a general purpose weapon suitable for assault, anti-armor attacks and cover fire in the support of infantry. It is also reasonably effective against low flying enemies. The rail gun is hooked into the armor's nuclear power supply and can be fed by a large ammo drum mounted on the back of the suit or small ammo clips. There is also a reserve clip magazine attached to the rail gun which can be accessed by the flip of a switch. This magazine is usually filled with silver ammunition for use against supernatural opponents.

Weight: 90 pounds (40.8 kg) for the gun, 120 pounds (54 kg) for the ammo-drum.

Primary Purpose: Assault

Mega-Damage: A full damage burst is 40 rounds and inflicts 1D4×10 M.D. At the flip of a switch the weapon can fire 10 shot bursts which inflict 2D6 M.D.

Maximum Effective Range: 4000 feet (1220m)

Rate of Fire: Equal to the combined hand to hand attacks (usually 4-6).

Payload: 2400 rounds per drum for 60 full strength bursts! The comparatively small clip magazine holds 200 rounds, equal to 5 full bursts. Reloading a drum will take about 5 minutes for those not trained, but a mere one minute by somebody trained in the use of power armor; a strength of 26 or higher is required.

**2. Shoulder Mini-Missile Launchers (2):** A pair of small missile launchers are mounted on each shoulder, providing the armor with some anti-armor and anti-aircraft capabilities. The missiles are also used for extra firepower against enemy infantry units, power armor and robot vehicles.

Primary Purpose: Anti-armor & Assault

Secondary Purpose: Anti-aircraft

Missile Type: Any mini-missile can be used, but armor piercing (1D4×10 M.D.) and plasma (1D6×10 M.D.) are standard issue. Fragmentation (5D6 M.D.) are used only for anti-personnel assault operations.

Mega-Damage: Varies with missile type.

Maximum Effective Range: Usually about a mile (1.6 km).

Rate of Fire: One at a time, or in volleys of two or three.

Payload: Six total; three missiles in each shoulder launcher. Reloading requires a second person to insert missiles from the top of the launchers and takes about one minute each.

**3. VL-40 Head Laser (1 or 2):** On the side of the head, parallel with the eyes, is a variable frequency laser. The IPA-40 operator needs only look and fire. The head lasers can be fired via a verbal command by the pilot (voice recognition prevents accidental firing) or by pressing a firing button on the side of the mechanism. The lasers are relatively small and unobtrusive but efficient line of sight weapons. Typically grunts and low ranking officers have one head laser while high ranking officers or Special Forces have two.

Primary Purpose: Defense

Mega-Damage: 2D6 M.D. per single blast or 4D6 M.D. from two.

Maximum Effective Range: 1000 feet (305 m)

Rate of Fire: Standard

Payload: Unlimited; the laser is hooked directly to the nuclear power supply of the suit.

**4. Retractable Vibro-Katanas (2):** A pair of retractable vibro-katanas, 3 feet (0.9 m) long, are located on each of the forearms. The blades are used for close combat, assassination and silent attacks.

Primary Purpose: Defense & Close Combat.

Mega-Damage: 4D6 M.D. each

**5. Forearm Blades (2):** An M.D. blade runs the length of the underside of each forearm like a menacing fin and ends in a point protruding a few inches beyond the elbow. It is used in close combat for slashing and jabbing opponents and to parry vibro-weapons without having to extend the vibro-blades.

Primary Purpose: Defense

Mega-Damage: 1D6 M.D. each.

**6. Energy Rifles, Light Rail Guns** and other weapons can be used by the man-sized **Katana** power armor as a substitute for the standard issue rail gun. Lighter, hand-held weapons are often preferred for espionage and special missions.

**7. Hand to Hand Combat:** Rather than use a weapon, the pilot can engage in mega-damage hand to hand combat. Characters of any Elite RPA O.C.C. get the bonuses found under the Elite Power Armor Combat Training in the **Rifts RPG**, page 45, plus the bonuses listed below. All others must use the bonuses from the Basic Power Armor Combat Training.

Bonuses for Dai-Katana Bugei power armor combat training: In addition to "elite" power armor training, the IPA-40 pilot is +1 on initiative, +2 to pull punch, an additional +1 to parry and dodge, +1 additional attack per melee at level three and suffers no prowl penalties! Further note that all military trained Dai-Katana Bugei (Ichto and Otomo troops and any *Elite RPA O.C.C.*) are skilled swordsmen and get the skills *W.P. sword* and *paired weapons* (can use two swords or daggers simultaneously to parry and strike) as part of their skill package.

**8. Sensor Note:** The Katana has all standard power armor sensors and optical systems, including passive nightvision (light amplification).

---

## IPA-45 Ikusa (or "Warrior")

---

The Warrior power armor has become popular among high-tech warriors of Samurai decent, Shoguns, mercenaries and RPA O.C.C.s. The power armor offers heavy mega-damage protection, durability, formidable weapon systems, and dynamic appearance. The fact that it resembles ancient samurai armor with a demonic face plate and four tall horns or blade-like appendages pointing up from the helmet, seems to enhance its appeal.

An Ikusa "knock-off" called the H-45 Warlord was released on the open market and quickly sold to adventurers, bandits and mercenaries, especially those operating in "The Zone" or waging mainland campaigns. However, Ichto took great offense over the copy and threatened war unless the manufacturing and sale of the **knock-offs** were stopped immediately. In a gesture to keep the peace, **H-Brand** agreed, provided it did not have to recall "the few thousand" they had sold. Ichto agreed, not realizing that over 10,000 had been already sold. Not one to let opportunity pass them by, **H-brand** continues to produce a few hundred a year and sell them on the sly. Ichto suspects as much, but is willing to overlook the infraction as long as numbers stay in the "few" hundred. The Ichto army tries to seize and/or destroy Ikusa knock-offs whenever they can. **Note:** The H-Brand Warlord armor has 20% less M.D.C., is 20% heavier, costs 10% less, but is otherwise identical.

**Model Type:** IPA-45 Ikusa

**Class:** Strategic Combat Power Armor

**Crew:** One

**M.D.C. by Location:**

Arms (2) — 80 each

Legs (2) — 140 each

**Rail Gun — 100**

Ammo Drum — 75

Mini-Missile Launch Tubes (8) — 10 each

Shoulder Laser — 15

Vibro-Swords (2) — 50 each

\* Head — 90

\*\* Main Body — 290



\* Destroying the head of the power armor will eliminate all forms of optical enhancement and sensory systems. The pilot must rely on his own human vision and senses. Any power armor bonuses to strike, parry and dodge are lost!

The head is a small and difficult target to hit. Thus, it can only be hit when an enemy makes a called shot, but even then the attacker is -2 to strike.

\*\* Depleting the M.D.C. of the main body will shut the armor down completely, rendering it useless.

#### **Speed:**

Running: 50 mph (80 kmph) maximum. Note that the act of running does tire its operator, but only at 10% of the usual fatigue.

Leaping: The robot legs can propel the power armor 15 feet (4.6 m) high or lengthwise with a short running start.

#### **Statistical Data:**

Height: 10 feet (3.0 m) from head to toe; add another 2 feet (0.6 m) for the horns/blades.

Width: 4.5 feet (1.4 m)

Length: 4 feet (1.2 m)

Weight: 1100lbs (495 kg)

Physical Strength: Equal to a P.S. of 34.

Cargo: None.

Power System: Nuclear, with an average energy life of 20 years.

Market Price: 6.2 million credits.

## **Weapon Systems**

**1. IR-70 Rail Gun:** Designed to be a general purpose gun, it is suitable for assault, anti-armor attacks and cover fire in the support of infantry. The weapon is mounted and stowed on the back, above and behind the right shoulder, like the Glitter Boy's, and pulled forward when needed. It is connected to the armor's nuclear power supply and is fed by a large ammo drum mounted on the back of the suit. There is a reserve clip magazine attached to the rail gun which can be accessed by the flip of a switch. This magazine is often filled with silver ammunition for use against supernatural opponents.

Primary Purpose: Assault

Mega-Damage: A full damage burst is 40 rounds and inflicts 1D6×10 M.D. At the flip of a switch the weapon can fire 10 shot bursts which inflict 3D6 M.D.

Maximum Effective Range: 4000 feet (1220 m)

Rate of Fire: Equal to the combined hand to hand attacks (usually 4-6).

Payload: 3200 round drum for 80 bursts! The clip magazine holds 200 rounds, equal to 5 full bursts. Reloading a drum will take about 5 minutes for those not trained, but a mere one minute by somebody trained in the use of power armor; a strength of 26 or higher is required.

**2. Mini-Missile Launchers (8):** Several tube style, one-shot mini-missile launchers are mounted along the entire length of the left arm.

These missiles can be fired while holding or using the vibro-swords.

Primary Purpose: Anti-Armor/Assault

Secondary Purpose: Defense

Missile Type: Any mini-missile type can be used but standard issue is armor piercing (1D4×10 M.D.), plasma or Heavy-Hitters (1D6×10 M.D.). Fragmentation or concussion missiles (5D6 M.D.) will be used in anti-personnel missions.

Mega-Damage: Varies with missile type.

Maximum Effective Range: Usually about a mile (1.6 km).

Rate of Fire: One at a time, or in volleys of two or three.

Payload: Eight. The launchers can be manually loaded; each takes about 10 seconds to reload.

**3. Shoulder Laser (1):** Mounted on the left shoulder is a small, snub-nosed laser. It can rotate 180degrees and has a 60 degree arc of fire.

Primary Purpose: Anti-Personnel

Secondary Purpose: Defense

Mega-Damage: 3D6 M.D. per laser blast.

Maximum Effective Range: 1200 feet (365.7 m).

Rate of Fire: Standard

Payload: Effectively unlimited.

**4. Vibro-Swords (2):** In keeping with the samurai motif, a daisho of vibro-swords is standard issue. Both the vibro-katana and wakazashi are giant-sized and deadly. The weapons can be used to parry M.D. attacks, including energy blasts (-6 to parry), arrows and missiles (-4 to parry).

Mega-Damage: Giant Wakazashi: 3D6 M.D.; Giant Katana: 5D6 M.D.

Bonuses: +1 to strike and parry.

**5. Energy Rifles, Rail Guns** or other hand weapons can be used instead or in addition to the standard armaments.

**6. Hand to Hand Combat:** Rather than use a weapon, the pilot can engage in mega-damage hand to hand combat. See Basic and Elite Power Armor Combat Training in the **Rifts RPG**, page 45. All abilities are the same except as follows:

Restrained Punch — 1D4 M.D.

Normal Punch or Kick — 2D6 M.D.

Power Punch — 4D6 M.D. (costs two melee attacks)

Leap Kick — 3D6 M.D. (costs two melee attacks)

Body Flip/Throw — 1D6 M.D.

Body Block/Tackle — 2D4 M.D.

## **IPA-50 "Grenadier"**

The Grenadier was created to give power armor commandos greater capabilities for anti-armor combat. To fight larger opponents, such as dragons or robots, an armor suit with more firepower was obviously necessary. Bristling with weapon systems and covered with extra armor plating, the Grenadier is the anti-armor combatant the army was looking for. Although large and extremely bulky, it still offers greater mobility and versatility than conventional vehicles and many bots and power armor.

A resourceful pilot in the IPA-50 Grenadier power armor is more than a match for most assault robots, slow-moving power armor and ground troops. This tough suit has made a reputation for itself as a "Giant Killer," has chased off dragons and elementals, and has shown favorable results when pitted against Glitter Boys! In fact, many authorities in the Republic of Japan fear that the IPA-50 may have been designed specifically to that end.

**Model Type:** IPA-50 Grenadier

**Class:** Military Assault Power Armor

**Crew:** One

**M.D.C. by Location:**

Hands (2) — 55 each

Arms (2) — 115 each

Legs (2) — 170 each

Shoulder Mini-Missile Launchers (2) — 100 each

Forearm Mini-Missile Launcher (1) — 50

Leg Mini-Missile Launchers (4) — 50 each

Main Gun — 225

Ammo Drum — 120

\* Head — 120

\*\* Main Body — 580

\* Destroying the head of the power armor will eliminate all forms of optical enhancement and sensory systems. The pilot must

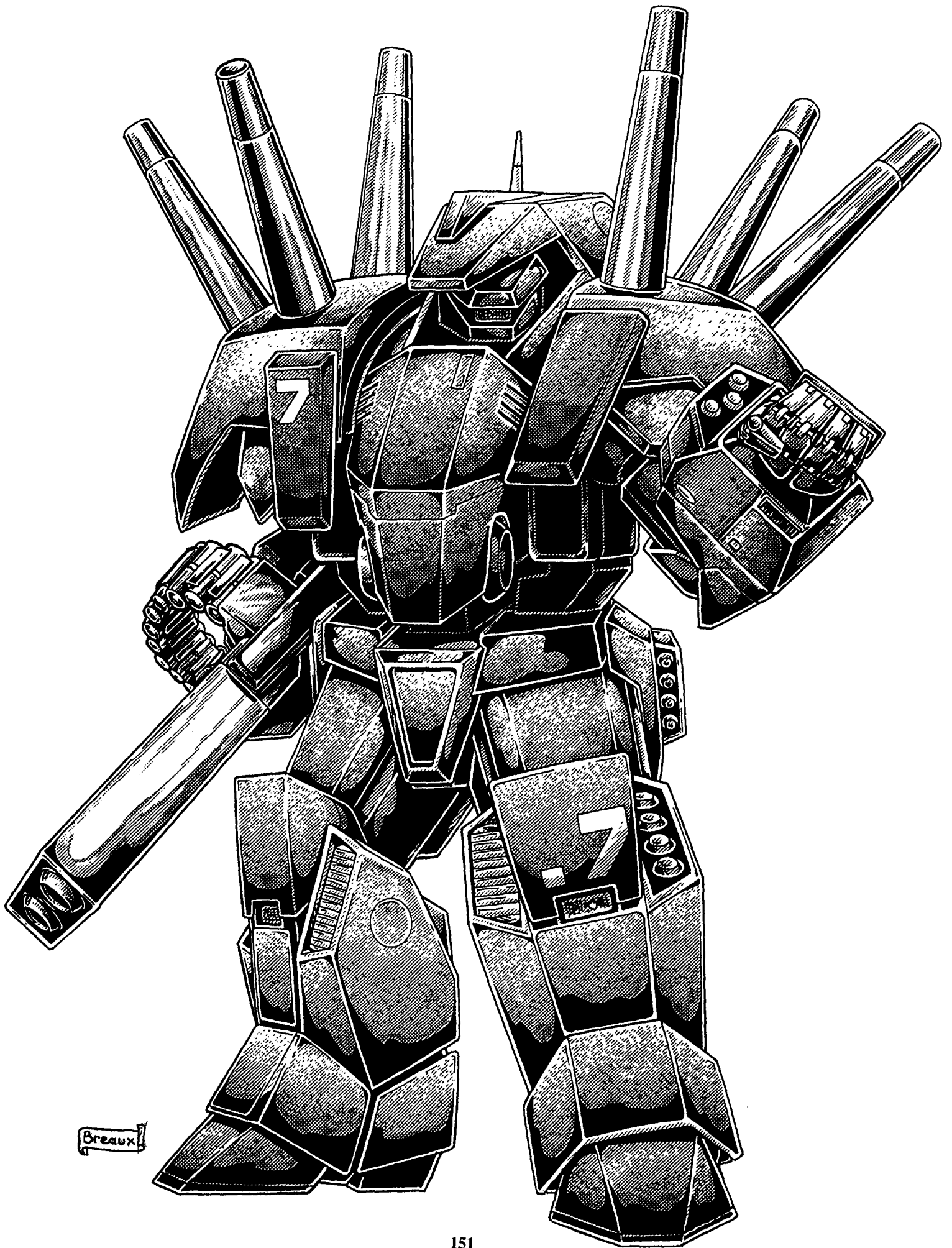

Breaux

rely on his own human vision and senses. Any power armor bonuses to strike, parry and dodge are lost!

The head is a small and difficult target to hit (shielded by mini-missile launchers). Thus, it can only be hit when a character makes a called shot, but even then the attacker is -3 to strike.

\*\* Depleting the M.D.C. of the main body will shut the armor down completely, rendering it useless.

### Speed:

Running: 50 mph (80.46 kmph) maximum. Note that the act of running does tire out its operator, but at 20% of the usual fatigue rate.

Leaping: The bulky robot suit can leap up to 10 feet (3.0 m) high or lengthwise from a short running start.

Flying: Flight is not possible

### Statistical Data:

Height: 9 feet, 4 inches, (2.8 m) from head to toe; the shoulder mounted missile launchers add another foot (0.3 m) to the overall height.

Width: 5 feet, 6 inches (1.65 m)

Length: 4 feet, 4 inches (1.3 m)

Weight: 1.3 tons

Physical Strength: Equal to a P.S. of 35.

Cargo: None

Power System: Nuclear, average energy life is 20 years.

Market Price: 16 million credits for a brand new, undamaged, fully armed Grenadier with complete weapon systems. Availability on the Black Market and even directly from Ichto is very poor. The suit is used prominently by the armed forces of Ichto Robotics. Less than 300 have been sold to the Otomo Shogunate and only a few hundred have been sold to mercenaries and foreigners. It is occasionally available to mercenaries and adventurers, but at twice the usual price. None have ever "gone missing" from military installations.

The IPA Grenadier is illegal in the Republic of Japan and rarely found even among criminal organizations.

## Weapon Systems

**1. IR-50 "Super-Launcher"** (1): A huge, double-barreled, fully automatic, 25 mm grenade launcher with a belt feed serves as the Grenadier's main gun. It resembles a big, bulky rail gun, but fires bursts of grenades.

Primary Purpose: Assault

Secondary: Anti-Armor

Mega-Damage: Multiply the damage from multiple grenades fired in the burst by the number fired, but only increase the blast radius by 5% per each grenade.

**Fragmentation Grenade (antipersonnel; light):** 2D6 M.D. to everything in a blast radius of 20 feet (6.1 m). Cost: 200 credits each.

**Heavy Fragmentation:** 3D6 M.D. to everything in a blast radius of 30 feet (9.1 m). Cost: 250 credits each.

**High Explosive Grenade (anti-armor):** 4D6 M.D. to a 6 foot (1.8 m) blast area. Cost: 150 credits.

**Plasma Grenade:** 5D6 M.D. to a 12 foot (3.65 m) area. Cost: 350 credits.

**Other types of Grenades:** Stun/flash, tear gas, concussion, and smoke types can be used for riot control, anti-terrorism, escape and rescue. AAD-Dissolvers are in high demand but rarely available unless stolen or purchased from the Black Market or adventurers (still stolen goods or the spoils of war).

Maximum Effective Range: 1600 feet (488 m)

Rate of Fire: One at a time or rapid succession like an automatic rifle. Rapid succession fire or burst firing two, four or a maximum of eight grenades fire within a split second of each other. Each burst counts as one melee attack/action.

Payload: 200; the ammo drum is split into two magazines each holding 100 rounds.

**2. Shoulder Mini-Missile Launchers** (2): Two launch-tubes on each shoulder contain mini-missiles.

Primary Purpose: Anti-Armor

Secondary Purpose: Assault

Missile Type: Any mini-missile can be used, but standard issue is armor piercing (1D4×10 M.D.), plasma or Heavy-Hitters (1D6×10 M.D.). Fragmentation and concussion missiles are seldom used.

Mega-Damage: Varies with missile type.

Maximum Effective Range: Usually about a mile (1.6 km).

Rate of Fire: One at a time, or in volleys of two, three, four or six.

Payload: 12 total; 6 per shoulder.

**3. Forearm Mini-Missile Launcher** (1): Mounted atop the left forearm (or right for left-handed pilots) is a three shot mini-missile launcher.

Primary Purpose: Anti-Aircraft

Missile Type: Standard issue missiles are heat-seeking (+5 strike) Heavy-Hitters (1D6×10 M.D.) or plasma (1D6×10 M.D.).

Mega-Damage: Varies with missile type.

Maximum Effective Range: Usually about a mile (1.6 km).

Rate of Fire: One at a time, or a volley of two.

Bonus: Heat-seeking missiles have +5 to strike.

Payload: Three

**4. Leg Mini-Missile Launchers** (4): Small mini-missile launchers, holding four (4) mini-missiles each, are mounted on the calf and thigh of each leg.

Primary Purpose: Anti-Armor

Secondary Purpose: Assault

Missile Type: Any mini-missile can be used, but standard issue is armor piercing (1D4×10 M.D.), plasma or Heavy-Hitters (1D6×10 M.D.). Fragmentation and concussion missiles are seldom used.

Mega-Damage: Varies with missile type.

Maximum Effective Range: Usually about a mile (1.6km).

Rate of Fire: One at a time, or volleys of two, three or four.

Payload: 16; 4 per launcher.

**5. Hand Lasers** (2): Built into the top of each hand is a light, short-range laser that can be used for defense or as a tool.

Primary Purpose: Defense

Secondary Purpose: Anti-Armor/Armor Cutting

Mega-Damage: 2D6 M.D. per laser blast. Simultaneous double blasts are not possible.

Maximum Effective Range: 1200 feet (365 m).

Rate of Fire: Standard

Payload: Effectively unlimited.

**6. Large energy rifles, rail guns** and other hand-held weapons can be used by the giant Grenadier but they are seldom issued or suggested.

**7. Hand to Hand Combat:** Rather than use a weapon, the pilot can engage in mega-damage hand to hand combat. The fingers on the hands are thick and designed to puncture and tear apart armor! The bonuses from Basic or Elite Power Armor Combat Training in the **Rifts RPG**, page 45, apply, plus the following additional considerations.

+1D6 M.D. for normal punch or kick, triple damage from power punch or leap/jump kick, but counts as two melee attacks, and a +1 to roll with punch, fall or impact.

**8. Sensor Systems of Note:** The standard range of optics, sensors and power armor features.



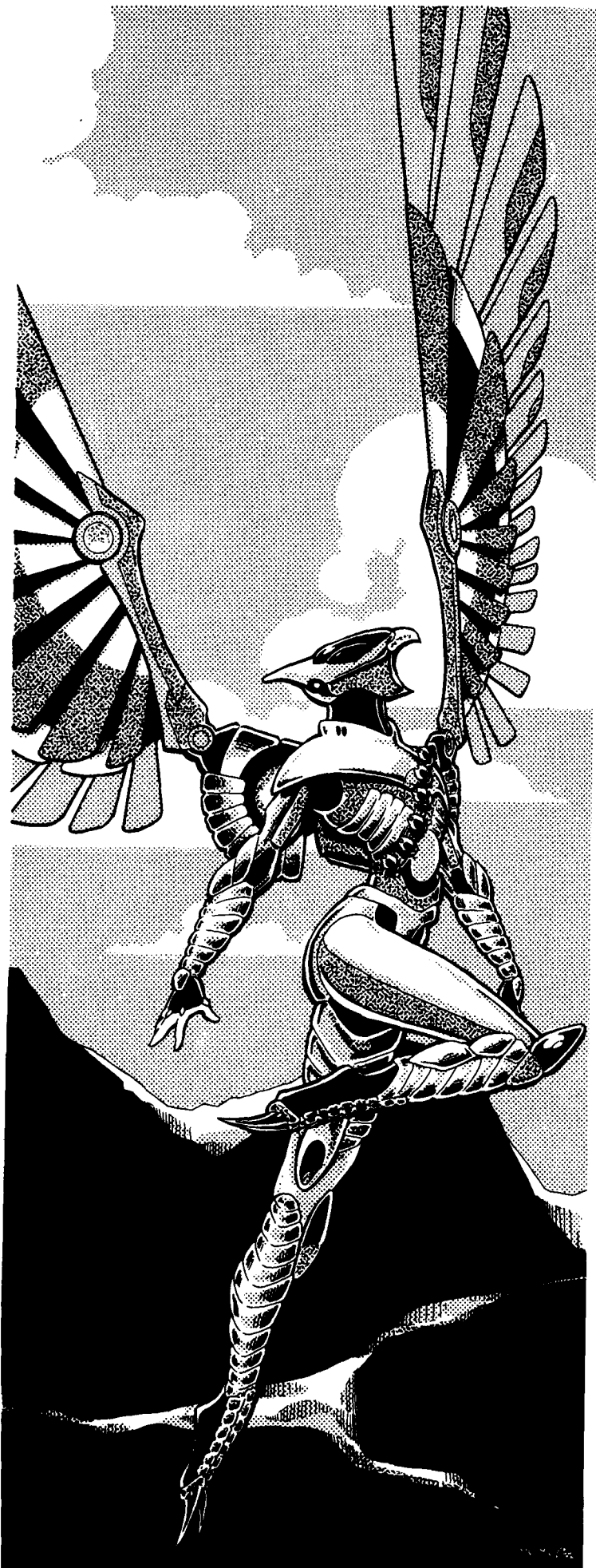

## IPA-60 Tazu-Tengu Power Armor

The IPA-60 Tazu-Tengu armor is named after the ancient bird-like beings from Japanese myth. It is a light suit of flying power armor designed for aerial speed and maneuverability. It has proven to be fast and reliable, but its light armor makes it more vulnerable to missile, robot and power armor attack than others. The IPA-62, described afterwards, is a heavier, but slower combat version.

The power armor has metallic wings patterned after those of a bird and can fold, with feathers retracting, when on the ground. A powerful jet thruster along with a trio of maneuvering jets in the back and additional jets in the feet, provide lift, control and speed. The thrusters are designed for silence, but still make a soft, rumbling motor sound accompanied by the rush of air from the jets. The helmet resembles that of a bird of prey and the feet end in sharp split toes that can be used as raking claws (1D6 M.D. per foot).

The Tazu-Tengu is popular among ordinary people, especially corporate executives for recreation and travel. It is one of the very few suits of power armor that is legal to own in the Republic of Japan, provided it is used safely. The color of the military armor is a soft blue-grey for better concealment in the daytime sky or a jet black for night maneuvers. Civilian suits are often brightly colored to avoid confusion with military and police units.

**Model Type:** IPA-60 Tazu-Tengu Power Armor

**Class:** Military Reconnaissance and Assault Armor

**Crew:** One

**M.D.C. by Location:**

Arms (2) — 70 each

Legs (2) — 100 each

\* Wings (2) — 95 each

Maneuvering Jets (3) — 25 each

Main Jet Thruster (Back) — 75

\*\* Head — 70

\*\*\* Main Body — 200

\* Destroying one wing means the Tengu armor can no longer fly. However, jet propelled leaps and low altitude hovering (100 feet/30.5 m) possible. Destroying the main thruster will reduce speed by 50%! Destroying maneuvering jets reduces aerial maneuvers by 12% per each one destroyed.

\*\* Destroying the head of the power armor will eliminate all forms of optical enhancement and sensory systems. The pilot must rely on his own human vision and senses. Any power armor bonuses to strike, parry and dodge are lost!

The head is a small and difficult target to hit. Thus, it can only be hit when a character makes a called shot, but even then the attacker is -3 to strike.

\*\*\* Depleting the M.D.C. of the main body will shut the armor down completely, rendering it useless.

**Speed:**

Running: 40 mph (64 kmph) maximum. Note that the act of running does tire its operator, but at 30% of the usual fatigue rate.

Leaping: The exoskeleton augmented legs can leap up to 12 feet (3.65 m) high or lengthwise (or 30 ft/9.2m lengthwise with wings extended) unassisted by the thrusters. A jet assisted leap propels the unit up to 100 feet (30.5 m) high and 150 feet (45 m) lengthwise; add 100 feet (30.5 m) to lengthwise if the wings are extended to glide.

Flying: The Tengu's rocket propulsion system enables it to hover stationary in the air or fly. Maximum flying speed is 350 mph (560 kmph), but cruising speed is considered to be around 100 mph (160 km). Glid-

ing speed is usually around 60 mph (96 kmph). A common ploy is to fly near a target and silently glide in for a landing. Maximum altitude is limited to about 10,000 feet (3048 m).

Flying Range: While the nuclear power supply of the Tazu-Tengu has years of life, the **thruster** jets need to cool after a maximum of 10 hours of flight when travelling at speeds above cruising, and twenty-four hours of cruising speed. However, with periodic stops and rest, the armor can function perfectly for days.



#### **Statistical Data:**

Height: 7 feet (2.1 m)

Width: Wings Down: 3 feet, 4 inches (1.0 m)

Wings Fully Extended: 15 feet (4.6 m)

Length: 3 feet, 8 inches (1.1 m)

Weight: 220 lbs (100 kg).

Physical Strength: Equal to a P.S. of 24.

Cargo: None.

Power System: Nuclear, average energy life is 16 years.

Market Price: 825,000 credits for a new, undamaged Tazu-Tengu without weapon systems. Good availability; the suit is extremely popular among security forces, mercenaries, adventurers and even ordinary (but wealthy) people for travel and recreation. It and the Super-Tengu are in heavy use by the **Ichto** and Otomo Shogunates as well as other kingdoms. The Tazu-Tengu is *legal* in the Republic of Japan, but it must be officially registered with the government and used safely.

### **Weapon Systems**

**1. Grenades/Bombs:** A waist belt and bandoleer style chest strap are typically worn by combat units to carry grenades which can be thrown or dropped like bombs. Typically, six to eight grenades are attached to the chest belt while four large military pouches hang from the waist belt with six grenades in each. An additional backpack or sack could contain another 20 to 40 grenades.

Primary Purpose: Assault

Secondary: Anti-Armor

Mega-Damage: Varies with grenade type.

**Fragmentation Grenade (antipersonnel; light):** 2D6 M.D. to everything in a blast radius of 20 feet (6.1 m). Cost: 200 credits each.

**Heavy Fragmentation:** 3D6 M.D. to everything in a blast radius of 30 feet (9.1 m). Cost: 250 credits each.

**High Explosive Grenade (anti-armor):** 4D6 M.D. to a 6 foot (1.8 m) blast area. Cost: 150 credits.

**Plasma Grenade:** 5D6 M.D. to a 12 foot (3.65 m) area. Cost: 350 credits.

**Other types of Grenade:** Stun/flash, tear gas, concussion, and smoke types can be used for riot control, anti-terrorism, escape and rescue. AAD-Dissolvers are in high demand but rarely available unless stolen or purchased from the Black Market or adventurers (still stolen goods or the spoils of war).

Maximum Effective Range: 200 feet (61 m) thrown (augmented by the armor's strength) or 500 feet (152 m) when *dropped* from the sky like a bomb. -2 to strike for each additional 100 feet (30.5 m) of height.

Rate of Fire: Typically, one or two are used/dropped on a target at a time. Each throw or drop of a grenade counts as one melee attack.

Payload: Typically approximately 32 hand grenades.

**2. Energy Rifles, Rail Guns** and other hand-held weapons can be used by this man-sized power armor. Laser rifles are the most popular because laser beams are silent and have excellent range. A **sidearm/pistol** and **vibro-blades** are also common weapons used with this armor.

**3. Hand to Hand Combat:** Rather than using a weapon, the pilot can engage in **mega-damage** hand to hand combat. See Basic and Elite Power Armor Combat Training in the **Rifts RPG**, page 45. There are no special bonuses or sensor systems for this light power armor.

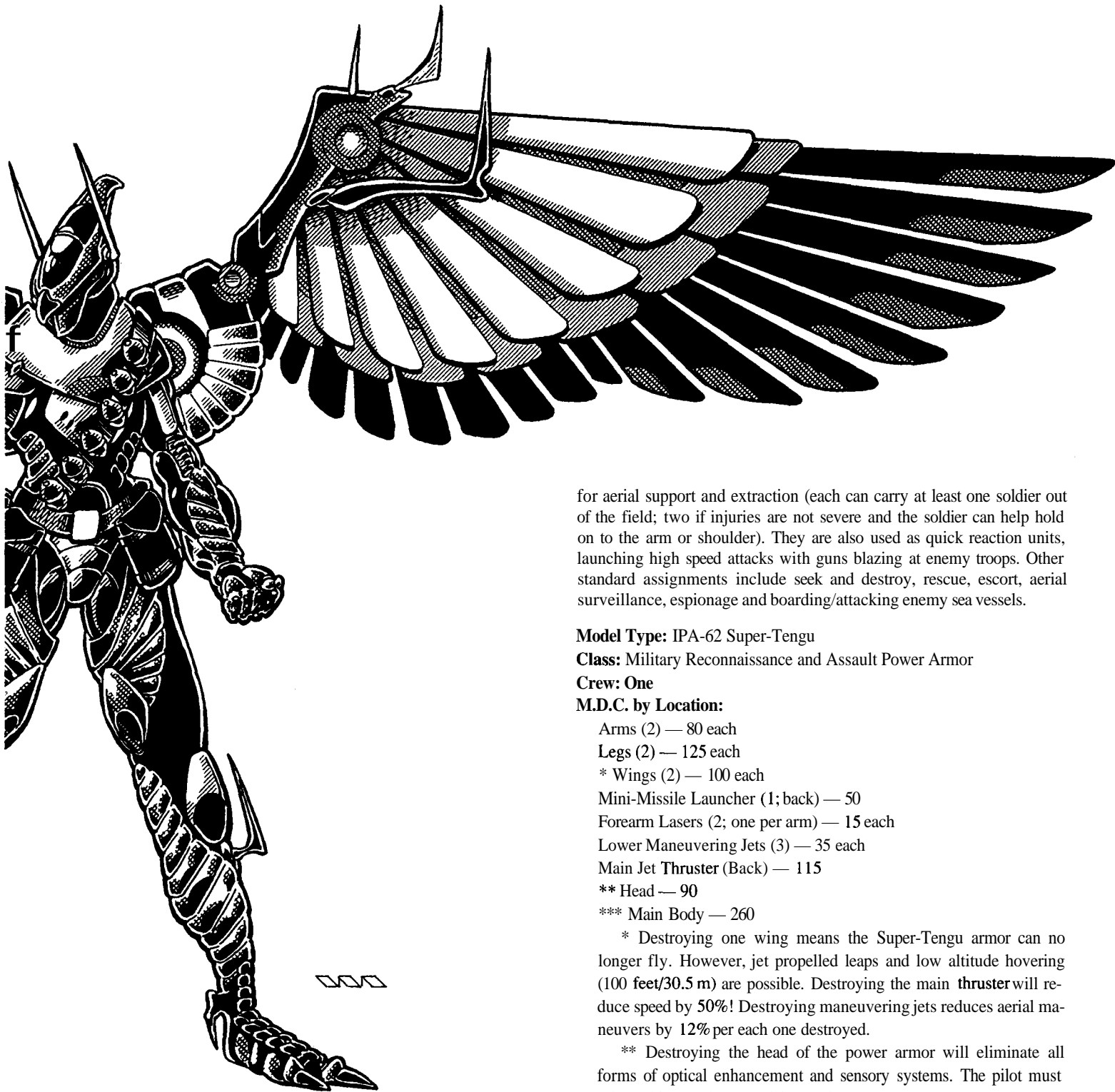

## IPA-62 “Super-Tengu”

The Super-Tengu is a heavier version of the IPA-60 Tazu-Tengu, sacrificing speed and mobility for increased armor and heavy weapons. However, it is still not as heavily armed and armored as many suits designed for ground combat, nor is it truly capable of engaging in air to air combat with fast moving fighter aircraft or assault helicopters.

The Super-Tengu is used in a wide range of missions, especially those which require speed, stealth and reconnaissance. Whenever an infantry unit goes into the field, a few IPA-60 or 62 Tengu will be sent ahead as scouts while several Super-Tengu will be placed on standby

for aerial support and extraction (each can carry at least one soldier out of the field; two if injuries are not severe and the soldier can help hold on to the arm or shoulder). They are also used as quick reaction units, launching high speed attacks with guns blazing at enemy troops. Other standard assignments include seek and destroy, rescue, escort, aerial surveillance, espionage and boarding/attacking enemy sea vessels.

**Model Type:** IPA-62 Super-Tengu

**Class:** Military Reconnaissance and Assault Power Armor

**Crew:** One

**M.D.C. by Location:**

Arms (2) — 80 each

Legs (2) — 125 each

\* Wings (2) — 100 each

Mini-Missile Launcher (1; back) — 50

Forearm Lasers (2; one per arm) — 15 each

Lower Maneuvering Jets (3) — 35 each

Main Jet Thruster (Back) — 115

\*\* Head — 90

\*\*\* Main Body — 260

\* Destroying one wing means the Super-Tengu armor can no longer fly. However, jet propelled leaps and low altitude hovering (100 feet/30.5 m) are possible. Destroying the main thruster will reduce speed by 50%! Destroying maneuvering jets reduces aerial maneuvers by 12% per each one destroyed.

\*\* Destroying the head of the power armor will eliminate all forms of optical enhancement and sensory systems. The pilot must rely on his own human vision and senses. Any power armor bonuses to strike, parry and dodge are lost!

The head is a small and difficult target to hit. Thus, it can only be hit when an attacker makes a called shot, but even then the opponent is -3 to strike. The hands, forearm lasers and back missile launcher are also just as difficult to hit.

\*\*\* Depleting the M.D.C. of the main body will shut the armor down completely, rendering it useless.

**Speed:**

Running: 40 mph (64 kmph) maximum. Note that the act of running does tire its operator, but at 30% of the usual fatigue rate thanks to the robot exoskeleton.

Leaping: Can leap up to 8 feet (2.4 m) high or lengthwise unassisted by the thrusters. A jet assisted leap propels the unit up to 100 feet (30.5 m) high and 150 feet (45 m) lengthwise.

Flying: The Super-Tengu's rocket propulsion system enables it to hover stationary or fly. Maximum flying speed is 260 mph (416 kmph), but cruising speed is considered to be around 100 mph (160 kmph). Gliding speed is around 60 mph (96 kmph). Maximum altitude is limited to about 6000 feet (1828 m).

Flying Range: While the nuclear power supply of the Super-Tengu has years of life, the thruster jets need to cool after a maximum of 10 hours of flight when travelling at speeds above cruising, and twenty-four hours of cruising speed. However, with periodic stops and rest the armor can function perfectly for days.

#### **Statistical Data:**

Height: 8 feet (2.1 m)

Width: Wings Down: 4 feet (1.2 m)

Wings Fully Extended: 16 feet (4.9 m)

Length: 4 feet (1.2 m)

Weight: 320 lbs (144 kg).

Physical Strength: Equal to a P.S. of 28.

Cargo: None.

Power System: Nuclear, average energy life is 16 years.

Market Price: 1.2 million credits for a new, undamaged Super-Tengu with basic weapon systems; missiles not included. Fair availability. The suit is popular among security forces, mercenaries, adventurers and even ordinary (but wealthy) people. The Super-Tengu is in heavy use by the Ichto and Otomo Shogunates as well as other kingdoms.

The Super-Tengu is illegal in the Republic of Japan, but its use is allowed to a handful of security forces under official registration and inspection by the government; very restrictive. The Republic does not use either of the Tengu power armors in its military, preferring to use the SAMAS.

## **Weapon Systems**

**1. Mini-Missile Launcher (1):** On the back, between the wings and above the jet thruster, is a mini-missile launcher.

Primary Purpose: Anti-Aircraft/Armored Vehicle

Secondary Purpose: Assault

Missile Type: Any type of mini-missile can be used.

Mega-Damage: Varies with missile type.

Maximum Effective Range: Approximately one mile (1.6km).

Rate of Fire: One at a time, or in volleys of two, three or four. Payload: 12 mini-missiles.

**2. Grenades/Bombs:** A waist belt and bandoleer style chest strap are typically worn by combat units to carry grenades which can be thrown or dropped like bombs. Typically, six to eight grenades are attached to the chest belt while four large military pouches hang from the waist belt with six grenades in each. An additional backpack or sack could contain another 20 to 40 grenades.

Primary Purpose: Assault

Secondary: Anti-Armor

Mega-Damage: Varies with grenade type. Same as the Tazu-Tengu.

Maximum Effective Range: 200 feet (61 m) thrown (augmented by the armor's strength) or 500 feet (152 m) when *dropped* from the sky like a bomb. -2 to strike for each additional 100 feet (30.5 m) of height.

Rate of Fire: Typically one or two are used/dropped on a target at a time. Each throw or drop of a grenade counts as one melee attack.

Payload: Typically approximately 32 hand grenades.

**3. Forearm Lasers (2):** Each of the forearms has a small, short-range; tactical laser built into it.

Primary Purpose: Defense

Mega-Damage: 3D6 M.D. per single blast or 6D6 M.D. per double blast.

Maximum Effective Range: 1200 feet (365 m)

Rate of Fire: Equal to the number of combined hand to hand attacks (usually 4-6).

Payload: Effectively unlimited.

**4. Energy Rifles, Rail Guns** and other hand-held weapons can be used by this man-sized power armor. Laser rifles are the most popular because laser beams are silent and have excellent range. A **sidearm/pistol** and **vibro-blades** are also common weapons used with this armor.

**5. Hand to Hand Combat:** Rather than using a weapon, the pilot can engage in mega-damage hand to hand combat. See Basic and Elite Power Armor Combat Training in the **Rifts RPG**, page 45. There are no special bonuses or sensor systems for this light power armor.

**6. Special features:** A grappling hook and towline can be fired out of a concealed housing in the left forearm. Similar to the *climb cord* bionic system, only the length of the cord is 150 feet (46 m).

Resistant to electricity and electro-magnetic energy; does half damage and the character is +3 to save.

Prowl penalty of -25%.

---

## **IPA-70 Mizu Mi**

---

Mizu Mi translated means "water serpent." The Ichto development team created the IPA-70 as an all-purpose, underwater power armor suit. Thus, it can be used for underwater exploration, salvage, rescue, mining, scientific study, and combat. The suit features an advanced propulsion system, sophisticated sensor equipment and a handful of weapon systems.

**Model Type:** IPA-70 Water Serpent

**Class:** Underwater Strategic Power Armor

**Crew:** One

**M.D.C. by Location:**

Shoulder Laser — 30

Mini-Torpedo Launcher — 70

Forearm Plasma Cutter — 45

Vibro-Cutter — 25

Underwater Propulsion Pack — 150

Arms (2) — 90 each

**Legs (2) — 160 each**

\* Head — 120

\*\* Main Body — 330

\* Destroying the head of the power armor will eliminate all forms of optical enhancement and sensory systems. The pilot must rely on his own human vision and senses. Any power armor bonuses to strike, parry and dodge are lost! Additionally, if the pilot is in an underwater environment he will quickly drown without the oxygen supply or be crushed by the pressure if deep enough.

The head is a small and difficult target to hit. Thus, it can only be hit when a character makes a called shot, but even then the attacker is -3 to strike.

\*\* Depleting the M.D.C. of the main body will shut the armor down completely, rendering it useless.

**Speed:**

Running: 40 mph (64 kmph) maximum. Note that the act of running does tire its operator, but only at 10% of the usual fatigue rate thanks to the robot exoskeleton.



Breaux!

Leaping: 10 feet (3 m) high or, with a short running start, the suit can leap 15 feet (4.6 m) lengthwise.

Swimming: 25 mph (40 kmph) maximum. The act of swimming, like running, does tire out the pilot but only at 10% of the normal fatigue rate. •

Underwater Propulsion: A built-in underwater propulsion system enables the power armor to rocket underwater up to speeds of 50 mph (80 kmph) and 40 mph (64 kmph) surfaced.

Range: Typically the pilot can operate the armor for 24 hours at maximum efficiency and up to 8 days without food. Air is purged and recycled automatically and will last eight days before becoming too stale to breathe.

Maximum Depth: 1.1 mile (1.8 km).

#### **Statistical Data:**

Height: 9 feet (2.7 m)

Width: 4.5 feet (1.4 m)

Length: 4 feet (1.2 m)

Weight: 350 lbs (158 kg)

Physical Strength: Equal to a P.S. of 38.

Cargo: None.

Power System: Nuclear, average energy life is 17years.

Market Price: 3.1 million credits. Poor availability.

## **Weapon Systems**

- 1. AT-70 Blue-Green Laser Weapon (1):** A small, twin-barrelled, laser blaster is located above the right shoulder. The barrels can rotate 45 degrees in any direction.

Primary Purpose: Defense

Mega-Damage: 2D6 M.D. per blast

Maximum Effective Range: 500 feet (152 m) underwater or 1000 feet (305 m) in an atmosphere.

Rate of Fire: Equal to the combined number of hand to hand attacks (usually 4-6).

Payload: Effectively unlimited.

- 2. Shoulder Mounted Mini-Torpedo Launcher (1):** A mini-torpedo launcher is mounted on the left shoulder.

Primary Purpose: Defense

Secondary Purpose: Anti-Sub/Assault

Torpedo Type: Standard issue is an equal mix of high explosive and plasma mini-torpedoes (1D6×10 M.D.).

Mega-Damage: 1D6×10 M.D.

Range: One mile (1.6 km).

Rate of Fire: One at a time, or in volleys of two, three or four.

Payload: 10 mini-torpedoes.

- 3. AT-90F Plasma Cutter (1):** Mounted atop the right forearm is a plasma torch/cutter. Though it can be used as a weapon in close combat the cutter is meant to be a tool for use in mining, salvage or rescue operations.

Primary Purpose: Tool & Rescue

Secondary Purpose: Defense

Mega-Damage: Three settings: 1D6 M.D., 3D6 M.D. and 6D6 M.D. per blast.

Maximum Effective Range: 12 feet (3.65 m)

Rate of Fire: Equal to the combined number of hand to hand attacks (usually 4-6).

Payload: 50 blasts

- 4. RVB-70 Vibro-Cutter:** A short, broad, flat, retractable vibro-blade is housed in the left forearm. The blade is oddly shaped because it is meant to be used primarily as a tool for digging and cutting, but can be used as a weapon if necessary.

Mega-Damage: 1D6 M.D.

- 5. Energy Rifles, Harpoon Launchers** and other hand weapons can be used easily by the man-sized power armor. The standard issue weapon of Republican Navy troopers is the AT-20 Underwater Assault Rifle. Officers will also be issued a waist belt with holster and energy sidearm.

- 6. Hand to Hand Combat:** Rather than using a weapon, the pilot can engage in mega-damage hand to hand combat. See Basic and Elite Power Armor Combat Training in the **Rifts RPG**, page 45. All abilities are the same except as follows:

Restrained Punch — 6D6 S.D.C.

Full Strength Punch — 2D6 M.D.

Power Punch — 4D6 M.D. (counts as two attacks)

Crush, Pry or Tear — 2D4 M.D.

+1 to dodge; +4 underwater

+2 to roll with impact

- 7. Sensor Systems of Note:** The **IPA-70** has the full range of optical systems, including laser targeting, telescopic, passive nightvision (light amplification), **thermo-imaging**, infrared, ultraviolet, and polarization. It also has all the other features common to most power armor.

A sonar system replaces the conventional radar.

Detectors: **Depth/pressure** gauge, metal detector and mineral analyzer.

Electro-adhesive pads: The hands and feet of the suit have voice activated electro-adhesive pads, allowing the power armor to climb and cling to the metal hulls of ships.

---

# Robots

---

## List of Robots

AT-1053 Ka-Kuma

AT-1063 Hi-Tora

IR-2015 Crab Walker/H-Brand Crawler (knock-off)

IR-2020 Wrecker/H-Brand Battler (knock-off)

IR-2040 Destroyer

IR-2050 Apocalypse

IR-2060 Banshee

IR-2070 Gemini

IR-4000 Tatsu ("Dragon")

---

## AT-1053 Ka-Kuma "Metal Bear"

Ka-Kuma means "Metal Bear," an apt name for this hulking giant. The general shape and slow, plodding movement is also reminiscent of the bear. The AT-1053 is a heavy artillery support infantry robot in the Republic of Japan's Armed Forces. It has proven to be a durable and reliable vehicle many times over in the field of combat. The **AT-1053** has two howitzer-like rail cannons that fire explosive projectiles at long distances. A number of close-range weapon systems adds to the **bot's** overall combat capabilities.

In most combat operations, the AT-1053 robots are kept in reserve as support weapons. As the forward infantry units advance, the "Metal Bear" follows behind at a distance. When the advancing infantry meets with heavy resistance, they radio firing coordinates to a squad of "Metal Bears" who respond with concentrated barrages from their rail cannons. The robot is also used to engage enemy aircraft with its missiles and big

guns. The robot will only be committed to frontline combat if the situation demands it, otherwise they continue to act as support and defensive units. The **Ka-Kuma** is often dispatched to engage giants, dragons, elementals and supernatural horrors. A squad of three "Metal Bears" and five SAMAS has proven to be particularly effective against one or two dragons or greater elementals.

**Model Type:** AT-1053 Ka-Kuma

**Class:** Ground Infantry Artillery Robot

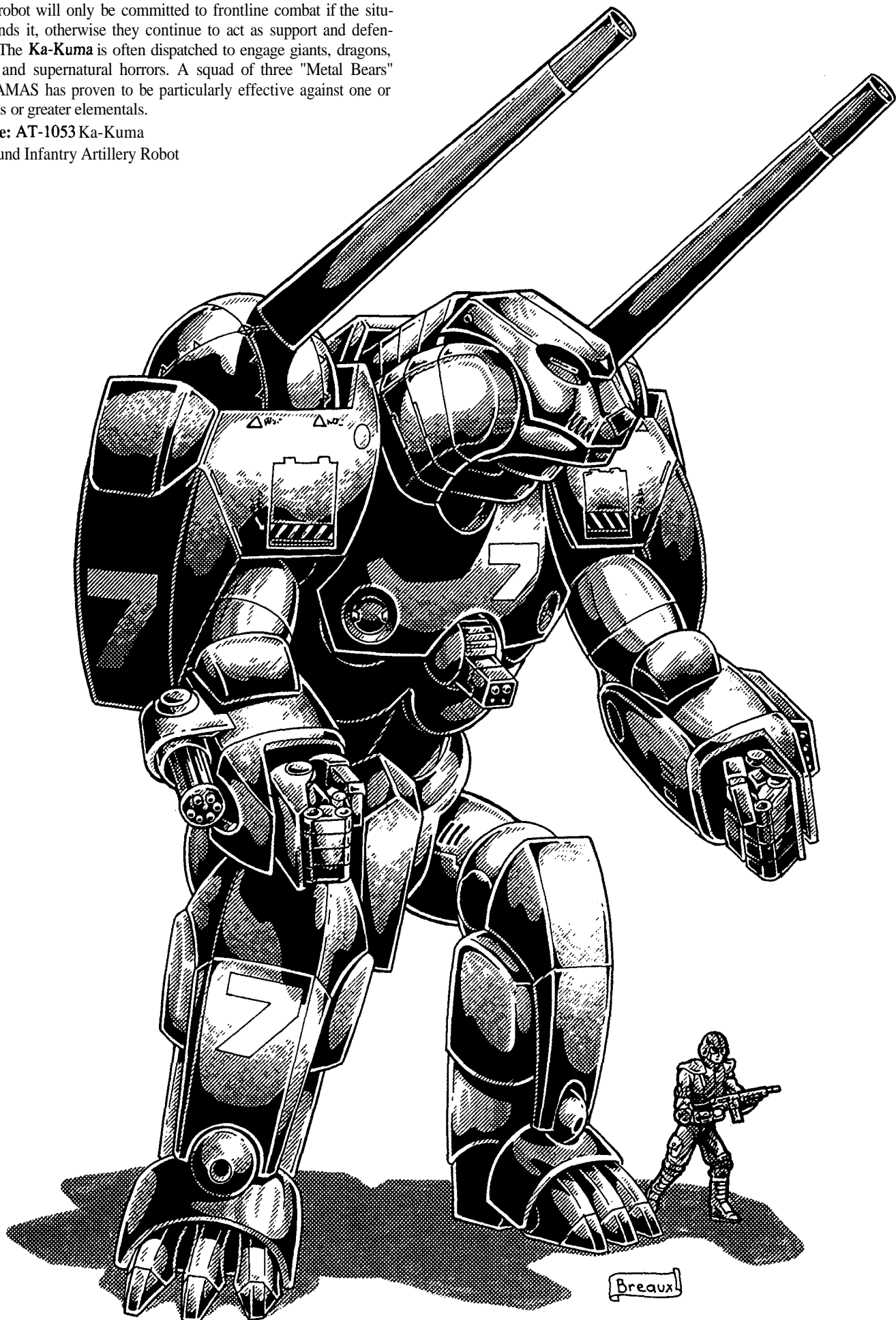



**Crew:** One pilot, co-pilot/communications/radar operator, and two gunners. Two additional passengers can also be accommodated comfortably.

**M.D.C. by Location:**

- Arms (2)** — 170 each
- Hand (1; left)** — 80
- Legs (2)** — 300 each
- Feet (2)** — 120 each
- Rail Cannons (2; shoulders)** — 250 each
- Shoulder Mini-Missile Launchers (2)** — 80 each
- Forearm Short-Range Missile Launcher (1; left)** — 80
- AT-2400 Rail Gun (1; right arm)** — 210
- Laser Belly Gun (1)** — 80
- Particle Beam Eyes (2; head)** — 20 each
- Flamethrowers (2; lower legs)** — 20 each
- Reinforced Pilot's Compartment** — 140
- \* Head** — 125
- \*\* Main Body (heavy plates)** — 590

\* Destroying the head of the robot will eliminate all forms of optical enhancement and sensory systems. The pilot must rely on his own human vision and senses. Any robot bonuses to strike, parry and dodge are lost!

The head is a comparatively small and difficult target to hit (shielded by the shoulder guns and missile launchers). Thus, it can only be hit when a character makes a called shot, but even then the attacker is -2 to strike (the **P-beam** eyes and mini-missile launchers are -5 to strike)

\*\* Depleting the M.D.C. of the main body will shut the armor down completely, rendering it useless.

**Speed:**

**Running:** 40 mph (64 km) maximum. Cruising speed is usually around 20 mph (32 km). Suitable for most terrains, including outer space and underwater; half speed underwater.

**Leaping:** Not possible.

**Flying:** Not possible.

**Statistical Data:**

**Height:** 30 feet (9.1 m)

**Width:** 13 feet (4 m)

**Length:** 10 feet (3.0m) not including the long barrels of the rail cannons.

**Weight:** 32 tons

**Physical Strength:** Equal to a P.S. of 50.

**Maximum Depth Tolerance (underwater):** 2 miles (3.2 km)

**Cargo:** Small area for the crew to store personal items.

**Power System:** Nuclear, average energy life is 17 years.

**Black Market Price:** 38 million credits for a new, undamaged unit with all weapon systems intact.

**Weapon Systems**

**1. AT-1053 Rail Cannons (2):** Two large cannons protrude from the upper chest and shoulder area of the robot. These weapons operate on the same principle as a rail gun but on a much larger scale. Instead of firing multiple rounds in machinegun fashion, the **AT-1503** cannons launch 20 to 50 pound (9-22.5 kg) explosive projectiles. Each cannon has its own gunner so the weapons can operate independently and accurately even while the Metal Bear is involved in other combat or on the move. Each can rotate 90 degrees in all directions and can be locked in any position while travelling.

The cannons are not designed to be used as close-range weapons and cannot fire at targets directly above or beneath the robot or at

targets closer than 1000 feet (305 m) unless they are also giant-sized (at least 15 feet tall/4.6 m). Each cannon is controlled exclusively by a gunner.

**Primary Purpose:** Indirect Fire Support

**Secondary Purpose:** Anti-Armor/Assault

**Mega-Damage:** Fragmentation (30 lbs/13.6 kg): 2D6x10 M.D., with a blast radius of 80 feet (24.4 m).

**High Explosive (HE; 20 lbs/9.1 kg):** 3D4x10 M.D. with a blast radius of 30 ft (9.1 m).

**Plasma (40 lbs/18 kg):** 3D6x10 M.D., with a blast radius of 50 feet (15.2m).

**Nuclear (50 lbs/22.5 kg):** 4D6x10 M.D., with a blast radius of 100 ft (30.5 m).

**Maximum Effective Range:** 7 miles (11.2 km)!

**Rate of Fire:** Four total per melee round; 2 shots per gun per melee round (15 seconds). Each gun is operated by its own gunner.

**Payload:** 100 explosive rounds total; 50 for each cannon. The usual mix for combat includes 40 Fragmentation, 10 High Explosive, 25 Plasma, 25 Nuclear, but can be used in any combination desired or necessary. Smoke missiles (no damage) or tear gas/riot control can also be used to provide cover.

**2. Shoulder Mini-Missile Launchers (2):** Concealed beneath each of the robot's large shoulder plates, under its big guns, is a mini-missile launcher. These launchers are used in close combat against ground troops, light armor, aerial opponents or against missile volleys. Controlled exclusively by the gunners.

**Primary Purpose:** Defense

**Secondary Purpose:** Anti-Armor/Assault

**Missile Type:** Any mini-missile type can be used. The standard complement of missiles include armor piercing (1D4x10 M.D.), plasma or **Heavy-Hitters** (1D6x10 M.D.).

**Mega-Damage:** Varies with missile type.

**Maximum Effective Range:** Usually about a mile (1.6 km).

**Rate of Fire:** One at a time, or in volleys of two, three or four.

**Payload:** 24; 12 in each launcher.

**3. Forearm Short-Range Missile Launcher (1):** Mounted on the left forearm is a four shot, short-range missile launcher. Usually fired by the pilot or co-pilot,

**Primary Purpose:** Anti-Aircraft

**Missile Type:** Any short-range missile type can be used. The standard load is heat-seeking (+5 strike) armor piercing (1D6x10 M.D.) or **plasma** (1D6x10 M.D.).

**Mega-Damage:** Varies with missile type.

**Maximum Effective Range:** Varies with missile type.

**Rate of Fire:** One at a time, or in volleys of two.

**Payload:** Four total.

**Heat-Seeker Bonus:** Once the heat-seeking missiles have locked onto the specific heat signature of a target, they strike with a +5 bonus to hit.

**4. AT-2400 Rail Gun (1):** The right forearm is a wicked looking, gatling-style rail gun with six barrels. The rapid-fire cannon is devastating against light aircraft, power armor and ground troops. Silver ammunition *can* be used instead of the standard ammunition listed below. Usually fired by the pilot or co-pilot.

**Primary Purpose:** Defense

**Secondary Purpose:** Assault

**Mega-Damage:** A burst is 60 rounds and inflicts 2D4x10 M.D.

**Maximum Effective Range:** 6000 feet (1830 m)

**Rate of Fire:** Standard; bursts or wild fire only.

**Payload:** An ammunition drum, located on the robot's back, holds 9000 rounds, that's 150 bursts! A second identical magazine, also on the

back, will begin to feed the cannon when the first has run out. That's 18,000 rounds (300 bursts) total! The ammo drums cannot be loaded in the field; it takes specialized equipment and 5 minutes to reload each magazine.

**5. Belly Laser Turret (1):** A double-barreled laser turret is built into the belly of this mechanical beast to combat ground troops. The turret swings 120 degrees from side to side and 90 degrees up and down. Operated by one of the gunners or the co-pilot.

Primary Purpose: Defense

Secondary Purpose: Assault

Mega-Damage: 3D6 M.D. per single blast or 6D6 M.D. per dual, simultaneous blasts.

Maximum Effective Range: 4000 feet (1220 m)

Rate of Fire: Equal to the combined number of hand to hand attacks of the pilot or co-pilot (usually 4-6).

Payload: Effectively unlimited.

**6. Flamethrowers (2):** A flamethrower is located in the lower portion of both legs. Each is built into a small turret capable of 45 degree rotation in any direction. It can be fired by any crew member.

Primary Purpose: Removal of obstacles.

Secondary Purpose: Anti-Personnel/Anti-Monster.

Mega-Damage: 1D4 M.D. per single blast or 2D4 M.D. per dual simultaneous blast of napalm-like fire. Plus there is a 01-90% likelihood of setting all combustible material, including fuel, wood, dry grass, clothes and body hair, on fire. The fire does an additional 1D4 M.D. per melee round and burns for a minimum of 2D4 minutes.

Maximum Effective Range: 200 feet (61.0 m)

Rate of Fire: Equal to the number of combined hand to hand attacks (usually 4-6).

Payload: A total of 50 blasts, 25 from each leg.

**7. Light Particle Beam Head Blasters (2):** A particle beam weapon is built into each eye of the bear-like head. They are used for self-defense and against enemy ground troops. The head can rotate 120 degrees from side to side and 60 degrees up and down. To shoot the operator simply looks and fires. Operated by one of the gunners or the co-pilot.

Primary Purpose: Defense

Secondary Purpose: Assault

Mega-Damage: 1D4x10 M.D. per single blast or 2D4x10 M.D. per dual, simultaneous blast.

Maximum Effective Range: 1200 feet (365 m)

Rate of Fire: Equal to the combined number of hand to hand attacks of the operator (usually 4-6).

Payload: Effectively unlimited.

**8. Hand to Hand Combat:** Like a bear, the left hand is a shovel shaped paw with four large, protruding claws/spikes used for stabbing and slashing armor, bots and vehicles. Rather than use a weapon, the pilot can engage in mega-damage hand to hand combat. See Basic Robot Combat Training or the **UAR-1 Enforcer** in the **Rifts RPG**, pages 44 and 45. All abilities are the same as the **UAR-1 Enforcer** except as follows:

Restrained Punch — 1D6 M.D.

Full Strength Punch — 3D6 M.D.

Power Punch/Stab/Slash (counts as two attacks) — 1D6x10 M.D.

Crush, Pry or Tear — 1D6 M.D.

Kick — Not possible; too unbalanced.

Body Flip/Throw - 1D6 M.D.

Body Block/Ram - 2D4 M.D.

Stomp - 2D4 M.D. against man-sized targets.

9. **Sensor Systems of Note:** In addition to the standard sensors and communication systems common to most giant combat robots, the **AT-1053** has full long-range radar and can track up to 200 different aerial targets, long-range radio communications and short-range (5 miles/8 km) sonar.

---

## AT-1063

### Hi-Tora "Fire Tiger"

---

This is a fast moving, light infantry support vehicle that is designed specifically for combating supernatural monstrosities. Many supernatural and magical creatures are vulnerable to fire, thus the "Fire Tiger" has a battery of flame based weapons. This unique robot vehicle resembles a cross between a giant samurai and humanoid feline. It can walk and run upright (at half speed) like a humanoid and has human-like arms, but it is designed to run and lope on all fours like a tiger. It stands on two legs to engage other bipedal adversaries, punch and strike like a human, to climb and to better negotiate certain environments and terrains.

This robot combined with the SAMAS, Glitter Boys and Ka-Kuma completes the robot forces of the Republic of Japan.

**Model Type:** AT-1063 Hi-Tora "Fire Tiger"

**Class:** Ground Infantry Robot Vehicle

**Crew:** Three; pilot, co-pilot/communications officer, and a gunner, with room for one passenger although a bit cramped.

**M.D.C. by Location:**

Arms (2) — 115 each

Hands (2) — 50 each

Retractable Finger Claws (8) — 20 each

Shoulder Flamethrowers (2) — 40 each

Legs (2) — 150 each

Feet (2) — 60 each

Reinforced Pilot's Compartment — 140

\* Head — 100

\*\* Main Body — 500

\* Destroying the head of the robot will eliminate all forms of optical enhancement and sensory systems. The pilot must rely on his own human vision and senses. Any robot bonuses to strike, parry and dodge are lost!

The head is a small and difficult target to hit. Thus, it can only be hit when a character makes a called shot, but even then the attacker is -3 to strike.

\*\* Depleting the M.D.C. of the main body will shut the armor down completely, rendering it useless.

**Speed:**

Running: 60 mph (96.5 km) maximum. Cruising speed is usually around 30 mph (48 km). Suitable for most terrains, including outer space and underwater. Half speed underwater.

Leaping: 30 feet (9.1 m) in height or lengthwise from a standing position, double from a running start.

Flying: Not possible.

**Statistical Data:**

Height: 22 feet (6.7 m) standing on two legs; 10 feet (3 m) running on all fours.

Width: 9 feet (2.7 m) from shoulder to shoulder

Length: 10 feet (3.0 m) standing; 17 feet (5.18 m) running on all fours.

Weight: 18 tons

Physical Strength: Equal to a P.S. of 40.

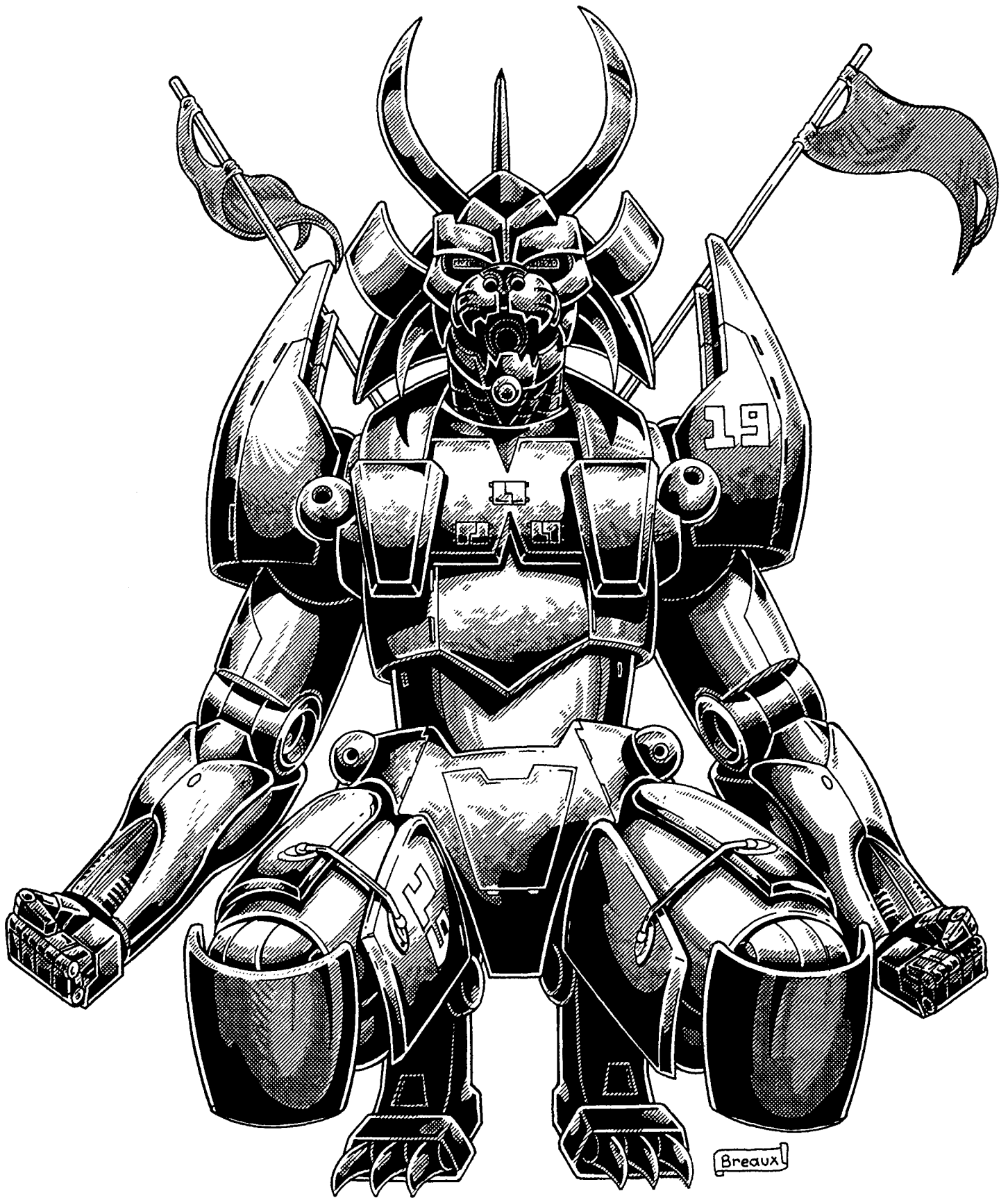

Maximum Depth Tolerance (underwater): 1.5 miles (2.4 km).

Cargo: Small area for the crew to store personal items.

Power System: Nuclear, average energy life is 25 years.

Black Market Price: 32 million credits for a new, undamaged unit with all weapon systems intact.

## Weapon Systems

**1. Mouth Flamethrower (1):** A heavy-duty flamethrower is built into the mouth of the cat-like robot, inflicting more damage than the traditional robot flame weapons.

Primary Purpose: Anti-Monster.

Secondary Purpose: Anti-Personnel.

Mega-Damage: 3D6 M.D. per single blast of napalm-like fire. Plus there is a 01-90% likelihood of setting all combustible material, including fuel, wood, dry grass, clothes and body hair, on fire. The fire does an additional 1D4 M.D. per melee round and burns for a minimum of 2D4 minutes.

Maximum Effective Range: 200 feet (61.0 m)

Rate of Fire: Equal to the number of combined hand to hand attacks (usually 4-6).

Payload: A total of 50 blasts.

**2. Flamethrowers (4):** A flamethrower is located in each shoulder and hip. Each is built into a small turret capable of 45 degree rotation in any direction. It can be fired by any crew member.

Primary Purpose: Removal of obstacles.

Secondary Purpose: Anti-Personnel/Anti-Monster.

Mega-Damage: 1D4 M.D. per single blast or 2D4 M.D. per dual simultaneous blasts of napalm-like fire. Plus there is a 01-90% likelihood of setting all combustible material, including fuel, wood, dry grass, clothes and body hair, on fire. The fire does an additional 1D4 M.D. per melee round and burns for a minimum of 2D4 minutes.

Maximum Effective Range: 200 feet (61.0m)

Rate of Fire: Equal to the number of combined hand to hand attacks (usually 4-6).

Payload: A total of 100 blasts, 25 from each shoulder and leg.

**3. Light Particle Beam Head Blasters (2):** A panicle beam weapon is built into each eye of the robot. They are used for self-defense and against enemy ground troops. The head can rotate 120 degrees from side to side and 60 degrees up and down. To shoot, the operator simply looks and fires. Operated by one of the gunners or the co-pilot.

Primary Purpose: Defense

Secondary Purpose: Assault

Mega-Damage: 1D4x10 M.D. per single blast or 2D4x10 M.D. per dual, simultaneous blasts.

Maximum Effective Range: 1200feet (365 m)

Rate of Fire: Equal to the combined number of hand to hand attacks of the operator (usually 4-6).

Payload: Effectively unlimited.

**4. Laser Fingers (2):** The first finger on each hand conceals a laser blaster. The pilot needs only to point and shoot.

Primary Purpose: Defense

Secondary Purpose: Assault

Mega-Damage: 3D6 M.D. per single blast. Simultaneous blasts are not possible.

Maximum Effective Range: 2000 feet (610 m)

Rate of Fire: Equal to the combined number of hand to hand attacks of the pilot or co-pilot (usually 4-6).

Payload: Effectively unlimited.

**5. Chest Spray:** Each breastplate of the chest contains three sliding compartments. Behind each is a spray mechanism that can fire a variety of chemical agents. The most common are as follows:

**Chemical Stench:** This chemical is often used to repel an enemy like a skunk or to instill some measure of confusion. If used against a living creature, the being will be distracted and repulsed by the horrible smell and is -4 on initiative, -2 to strike, parry and dodge, -20% on all skill performance; half if the character makes a successful save vs non-lethal poison.

If used against other robots and power armor, it has little effect on those inside unless the armor and inner pilot's compartment are breached. However, it will mark and identify the antagonist because the chemical stench lasts 1D4 days and can be smelled 2500 feet

(762 m) away; twice that distance for Dog Boys and other creatures with a sensitive sense of smell (add +10% to track by smell).

**M.D. Acid:** 3D6 M.D. per melee round for 1D6+1 rounds or until washed off with a chemical solution (water won't help) when used against M.D. armor, dragons and most supernatural creatures (only 1D6 M.D. against **elementals**, ancient dragons and gods). Triple damage if sprayed in the eyes, mouth or open wounds of many mega-damage creatures (no extra damage to gods and elementals).

**Tear Gas:** The steaming chemical will instantly affect all characters without protective masks or environmental body armor. The eyes burn, sting and water profusely, causing great discomfort and makes seeing clearly impossible. The gas also makes breathing difficult and irritates exposed skin. The effects last for 3D4 minutes. The 25 foot (7.6) cloud dissipates in about five minutes unless blown away by the wind (dissipating quickly in 1D4 minutes). The victims of tear gas are -10 to strike, parry and dodge, -3 on initiative and lose one melee **attack/action** for each of the next 1D6+1 melee rounds. Those in environmental armor are completely safe and not affected. Effective against most human-like D-bees and even the oni of the One Hundred Demons, but at half the standard penalties and for half as long.

**Fire Retardant Foam:** Each triple spray covers a 30 foot (9 m) diameter.

**Water/Holy Water:** Ideal against vampires and certain oni. A single spray does 1D6x10 damage to vampires, a triple spray does 3D6x10.

Maximum Effective Range: 120 feet (36.6 m); may be 25% to 50% shorter if spraying against a strong wind.

Area of Effect: A single spray covers a diameter of 10 feet (3 m), a double spray 20 feet (6.0 m), and a triple spray 30 feet (9.1 m) in diameter.

Rate of Fire: Equal to the combined number of hand to hand attacks of the pilot or co-pilot (usually 4-6).

Payload: 72 single sprays (24 triple sprays); 12 per each spray housing (3 per breast plate). Typically, only one or two different types of chemicals are used, one type per breastplate.

**6. Hand to Hand Combat:** Four giant-sized **vibro-blades** can project from the knuckles of each hand for a stabbing or slashing claw attack as well as parrying.

Rather than use a weapon, the pilot can engage in mega-damage hand to hand combat. See Basic Robot Combat Training or the UAR-1 Enforcer in the **Rifts RPG**, pages 44 and 45. All abilities are the same as the *UAR-1 Enforcer* except as follows:

Restrained Punch — 1D4 M.D.

Full Strength Punch or Kick — 2D6 M.D.

Power Punch (counts as two attacks) — 3D6+4 M.D.

**Vibro-Claw** Punch/Stab/Slash — 4D6 M.D.

**Vibro-Claw Power Punch/Stab** (two attacks) — 1D4x10+8 M.D.

Crush, Pry or Tear — 1D6 M.D.

Leap Kick (counts as two attacks) — 4D6 M.D.

Body Flip/Throw — 1D4 M.D.

Body Block/Ram — 2D4 M.D.

Stomp — 1D4 M.D. against man-sized targets.

+4 to parry, +3 to dodge and +2 to strike in hand to hand combat.



# IR-2015 Kani "Crab Walker"

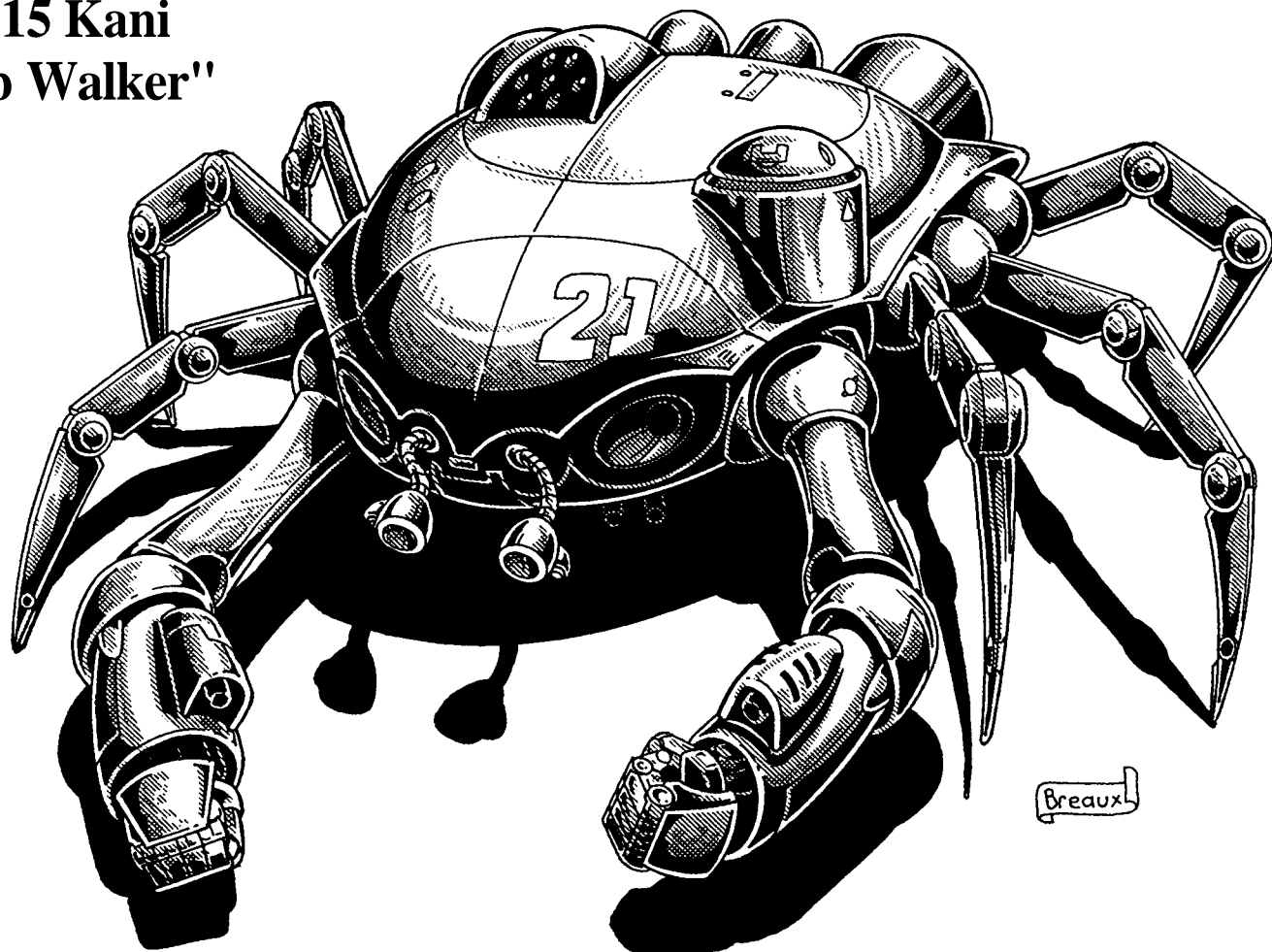

The walker is a three-man robot vehicle with a disk or crab-shaped body, six crab-like legs and a pair of forward arms and hands. This robot was designed as an all-purpose vehicle suitable for reconnaissance, exploration, rescue, labor and salvage above and below the sea.

As an underwater vehicle, the legs fold up and the clam-shaped body can skim across the ocean's surface or be propelled underwater by four powerful thrusters, or the bot can walk along the sea floor. A pair of infrared search lights are mounted on flexible stalks, like the antennae of a crab, so that they can point in any direction or be inserted in narrow crevices and openings. A small video camera attached under each light sends pictures back to the vehicle. The mechanical arms have fully articulated hands and are used for retrieving salvage, collecting specimens, and performing repairs. A laser tool is mounted on the right arm and a plasma torch on the other. The pads of the feet are electromagnetic and can attach firmly to submarines, ships and other vessels made of iron.

The IR-2015 is also suitable for travel and exploration on the surface, including climbing steep mountain trails, ruins and light forest. It also performs adequately under light combat conditions and has become extremely popular among adventurers, travelers, merchants and fishermen. It is used by some mercenaries, but most prefer power armor or heavier combat bots.

Note: The Crab Walker has been knocked-off by H-Brand which calls its model the "All-Terrain Crawler." It has 10% more armor M.D.C and costs 10% less, but is 10% slower and has half the depth tolerance.

## Model Type: IR-2015

Class: All-Terrain Reconnaissance and Work Robot.

Crew: One pilot, and two passengers (usually a co-pilot and communications operator). Two additional passengers can squeeze in, but it makes quarters a bit cramped and uncomfortable, especially for long journeys.

## M.D.C. by Location:

- \* Hands (2) — 25 each
- Forward Arms (2) — 88 each
- Legs (6) — 130 each
- Feet Pads (6) — 40 each
- Rear Jets (4) — 50 each
- \*Directional Jets (8; tiny) — 10each
- \* Forward Spotlights (2) — 5 each
- \* Belly Spotlights (4) — 5 each
- \* Infrared Stalk Lights (2) — 18 each
- \* Belly Laser Turret (1) — 65 each
- \* Forward Mini-Missile Launchers (2) — 18each
- Back/Top Mounted Short-Range Missile Launcher (1) — 90
- \* Plasma Torch (1; left forearm) — 20
- \* Laser Torch (1; right forearm) — 20
- Reinforced Pilot's Compartment — 90
- \*\* Main Body — 200

\* A single asterisk means the item is a small or difficult target to strike and requires the attacker to make a called shot. Each is -4 to strike.

\*\* Depleting the M.D.C. of the main body will shut the armor down completely, rendering it useless.

## Speed:

Running on dry land: 40 mph (64 km) maximum. Suitable for most terrains, including outer space and underwater.

Running Underwater: 25 mph (40 km) maximum.

Underwater: Thrusters give it a maximum underwater speed of 30 knots (35 mph/56 km). Riding on the surface, the vehicle has a speed of 25.8 knots (30 mph/48 km).

Maximum Depth Tolerance (underwater): 1.2 miles (1.9 km)

Leaping: Not possible.

Flying: Not possible.

**Statistical Data:**

Height: 9 feet (2.7 m) when standing on its legs. 5 feet (1.5 m) with legs folded.

Width: Roughly circular; 8 feet (2.4 m) in diameter.

Length: 12 feet (3.65 m) including the rear **thrusters**.

Reach of the arms: 10 feet (3.0 m)

Weight: 2.2 tons

Physical Strength: Equal to a P.S. of 28.

Cargo: Small area for the crew to store personal items.

Power System: Nuclear, average energy life is 20 years.

Market Price: 4 million credits from **Ichto**; 3.2 million from **H-Brand**.

Used Kani can cost as little as 1.5 million, but typically have only 50% of their original M.D.C.

## Weapon Systems

**1. Short-Range Torpedo/Missile Launcher (1):** A missile launcher is mounted on the back of the crab-walker. Torpedoes or air missiles can be used.

Primary Purpose: Anti-Submarine

Secondary Purpose: Defense

Torpedo Type: Standard armament is a mix of high explosive (2D4×10 M.D.) and plasma (1D6×10M.D.) torpedoes, or missiles.

Mega-Damage: Varies with torpedo type.

Maximum Effective Range: 5 miles (8 km)

Rate of Fire: One at a time, or in volleys of two, three or four.

Payload: 8

**2. Forward Mini-Torpedo/Missile Launch Tubes (2):** Located in the front of the robot is a pair of launch tubes that can fire mini-torpedoes or mini-missiles.

Primary Purpose: Anti-Armor

Secondary Purpose: Anti-Monster

Torpedo Type: Any mini-torpedo can be fired. Standard issue torpedoes are high explosive or plasma (1D6×10 M.D.)

Mega-Damage: Varies with torpedo type.

Maximum Effective Range: One mile (1.6 km)

Rate of Fire: One at a time, or in volleys of two.

Payload: Six; three in each launch tube.

**3. Belly Laser Turret (1):** A double-barreled, blue-green laser is mounted on the underbelly of the robot. It can rotate 360 degrees and has a 30 degree arc of fire.

Primary Purpose: Defense

Secondary Purpose: Assault

Mega-Damage: 2D6 M.D. per single blast or 4D6 M.D. per double blast.

Maximum Effective Range: 1800feet (549 m)

Rate of Fire: Equal to the combined number of hand to hand attacks (usually 4-6).

Payload: Effectively unlimited.

**4. Forearm Laser Torch (1):** A short-range laser used as a tool for making repairs and cutting salvage.

Primary Purpose: Tool

Secondary Purpose: Defense

Mega-Damage: Four settings: 2D6 S.D.C., 2D4×10 S.D.C., 1D6 M.D. and 2D6 M.D. per blast.

Maximum Effective Range: 40 feet (12.2m)

Rate of Fire: Equal to the combined number of hand to hand attacks (usually 4-6).

Payload: Effectively unlimited.

**5. Plasma Torch/Cutter (1):** Another tool used for cutting and welding above and below the waves.

Primary Purpose: Tool

Secondary Purpose: Defense

Mega-Damage: Three settings: 1D4 M.D., 2D4 M.D. and 3D6 M.D. per blast.

Maximum Effective Range: 10 feet (3.0 m)

Rate of Fire: Equal to the combined number of hand to hand attacks (usually 4-6)

Payload: Effectively unlimited.

**6. Hand to Hand Combat:** Rather than use a weapon, the pilot can engage in mega-damage hand to hand combat. See Basic Robot Combat Training in the **Rifts RPG**, pages 44 and 45.

Damage & Bonuses from Crab-Walker Combat Training:

Restrained Claw Strike — 1D4 M.D.

Full Strength Claw Strike — 1D6 M.D.

Power Claw Strike — 2D6 M.D. (counts as two attacks)

Crush, Pry or Tear — 1D4×10 M.D.

No Kicks

No Body Flip/Throw

Body Block/Tackle — 6D6 M.D.

Propulsion Assisted Body Block — 4D6 M.D.

+2 to dodge, +4 underwater

+2 to roll with **impact/fall**

Two (2) attacks per melee to start

+1 melee attack at levels six and twelve

**7. Sensor Systems of Note:** Basic robot systems plus radar and sonar, and infrared optics and searchlights.

---

## IR-2020 Wrecker

---

The **IR 2020 Wrecker** is not designed for combat, but for demolition and construction. It is produced by Ichto for use in the mass market. Any decent-sized construction company will own at least one such robot. The Republic of Japan has purchased nearly a thousand of these robots for both military and civilian applications. Wrecker bots are even in use underwater, although these vehicles have undergone modifications.

In construction, the Wrecker is suited to basic tasks such as digging, pulling, lifting, holding items in place, building and, of course, demolition. Two heavy arms, operated by the pilot, are used to pull down buildings, lift girders, pile rubble, etc. Mounted on the forearm of each is a giant-sized, buzz-saw style **vibro-blade** used for cutting girders, sheet metal and destruction of condemned buildings. The first finger of the right hand is also a plasma torch used for cutting and welding. A pair of small, retractable arms are housed in the center of the chest. These are used for handling explosives and light tasks and fine detail work. One small arm has a built-in laser torch/welder while the other has a computer jack.

Although the Wrecker may be intended and predominantly used for construction and demolition, the bot can also be used in combat with reasonable effectiveness. Mini-missile or short or medium-range missile launchers can be mounted on the back or above each shoulder. In the alternative, a laser or ion cannon can be used. These simple and inexpensive (about 1.1 million per weapon system; three maximum) systems provide the lumbering robot with ranged weapons while maintaining good hand to hand combat capabilities. Of course, the small arms can use any assault rifle or light rail gun as well.

In fact, **H-Brand** has designed an exact knock-off called the *Battler-1* (20% less M.D.C. than the Ichto brand Wrecker) and a combat ver-

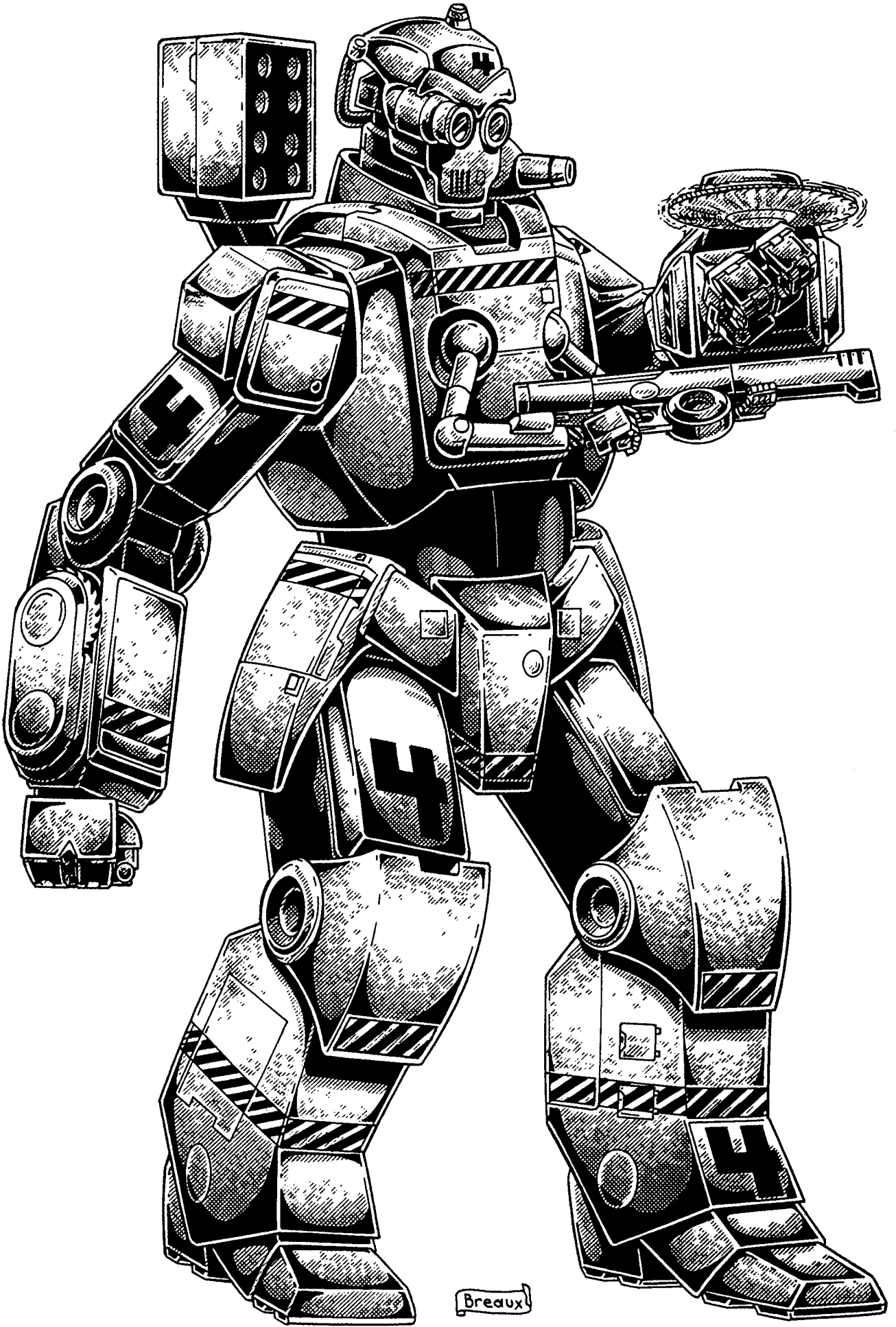



sion known as the **Battler-2**. The combat Battler-2 comes **standard** with a pair of ion turrets mounted on the shoulder and a mini-missile launcher on the back. Further modifications are also possible, such as replacing one or both buzz-saws with forearm blasters, mini-missile launchers, or vibro-swords. **Note:** IR2020 Wreckers are never sent into combat by the Republic of Japan and rarely by the **Ichto** Province or Otomo Shogunate. However, they are frequently used by mercenaries, adventurers and secondary Shogun powers. The Republic considers this an example of Ichto's and **H-Brand's** indiscriminate sale of a dangerous robot that can be easily modified and augmented for combat by anybody who can afford it.

**Model Type:** IR-2020 Wrecker

**Class:** Ground Labor Robot Vehicle

**Crew:** Two; pilot and co-pilot. Pilots using the **bot** for construction and demolition must have the two demolition skills and basic mechanics.

The co-pilot is typically an operator/mechanical **and/or** electrical engineer. There is also room for one passenger, although very cramped.

**M.D.C. by Location:**

Large Arms (2) — 200 each

Large Hands (2) — 90 each

\* Small Grasping Arms & Hands (2) — 60 each

\* Forearm Buzz-Saws (2) — 50 each

Fusion Block Compartment (1; hip) — 72

Optional Shoulder Weapon (1 or 2) — 80 each

Optional Missile Launcher (1 or 3) — 100 each

Legs (2) — 300 each

**Feet (2) — 150 each**

Reinforced Pilot's Compartment — 150

\* **Head — 130**

\*\* Main Body — 480 (384 for **H-Brand** versions)

\* A single asterisk means the item is a small or difficult target to strike and requires the attacker to make a called shot. Each is -3 to strike.

Destroying the head of the robot will eliminate all forms of optical enhancement and sensory systems. The pilot must rely on his own human vision and senses. Any robot bonuses to strike, parry and dodge are lost!

\*\* Depleting the M.D.C. of the main body will shut the bot down completely, rendering it useless.

**Speed:**

**Running:** 40 mph (64 km) maximum. Suitable for most terrain, including outer space and underwater. Half speed underwater.

**Leaping:** The robot legs are not made for leaping, but the bot can leap 10 feet (3.0 m) high and 20 feet (6.1 m) lengthwise with a short running start.

**Climbing & Rappelling:** The robot can climb girders, piles of debris, mountain cliffs and rappel up and down steel cables. Base skill proficiency is **75%/60%**; add 10% if the pilot also has a climbing skill.

**Digging:** 3D6x10 feet (9.1 to 56 m) of tunnelling per hour. Mining is slower (half) because the pilot is looking for mineral deposits.

**Flying:** Not possible.

**Statistical Data:**

**Height:** 24 feet (7.3 m)

**Width:** 12 feet (3.5 m)

**Length:** 6 feet (1.8 m)

**Weight:** 28 tons

**Physical Strength:** Large arms and legs are equal to a P.S. of 48, but the small arms are only P.S. 24.

**Cargo:** Small area for the crew's tool kit and lunch box. A refrigerated water dispenser is standard (10 gallons/37.9 liters). **Power System:** Nuclear, with an average energy life of 20 years.

**Market Price:** 11 million credits for a new construction robot, 7 million for a reconditioned, used bot (has **1D4x10%** less M.D.C.). Replacement arms cost 85,000 credits per small one (frequently destroyed in handling explosives) or 195,000 per large one. Replacement buzz-saws cost 32,000 each.

H-Brand **Battler-1** costs 10 million credits, while the standard combat version, the Battler-2, costs 14 million credits, but includes a basic optic package, radar, targeting and medium-range communications systems. A **special, "full"** modifications package, including enhanced speed (50 mph/80 km), one forearm laser replacing one of the buzz-saws (2000 ft/610 m range, 4D6 M.D.) and full armor (480 M.D.C.) costs 19 million credits. This modified **Battler/Wrecker** is frequently identified as the Battler-3 and is usually the Ichto IR-2020 Wrecker with a weapon and modifications added to it.

## Weapon Systems

**1. Forearm Buzz-Saws (2):** A large circular saw designed for cutting M.D.C. materials.

**Mega-Damage:** 5D6 M.D. each.

**2. Plasma Cutter (1; hand):** The first finger on the right or left hand (depending on the requirements of the pilot) is a plasma torch.

**Primary Purpose:** Cutting and welding.

**Secondary Purpose:** Mining and demolition

**Mega-Damage:** Four settings: 1D6x10 S.D.C., 3D6x10 S.D.C., 3D6 M.D. and 1D4x10M.D. per blast.

**Maximum Effective Range:** 20 feet (6.1 m)

**Rate of Fire:** Equal to the combined number of hand to hand attacks (usually 4-6).

**Payload:** Effectively unlimited.

**3. Laser Torch in the Small Arm (1):** A precision laser torch is built into the forearm of one of the small grasping arms, usually the right one. In addition to construction use, the laser can be used in short-range combat. **Note:** The small arms with their fully articulated, human-like hands can also wield pistols, rifles, swords, clubs and tools. The left arm has a computer jack for linking with computer systems and heavy equipment.

**Primary Purpose:** Cutting and welding tool.

**Secondary Purpose:** Defense

**Mega-Damage:** Four settings: 3D6 S.D.C., 1D6x10S.D.C., 1D6 M.D. and 2D6 M.D. per blast.

**Maximum Effective Range:** 200 feet (61.0 m)

**Rate of Fire:** Equal to the combined number of hand to hand attacks (usually 4-6).

**Payload:** Effectively unlimited.

**4. Fusion Block Compartment (1):** A small compartment is located on the robot's hip. Five to ten fusion blocks are held within the compartment which can be accessed by the large and small grasping arms for placement in demolition. The blocks are armed from the co-pilot's console or by hand with a time delay of anywhere from 30 seconds to 10 minutes. The fusion blocks *are not* designed for throwing, but for strategic placement by the arms.

**Primary Purpose:** Demolition and mining.

**Mega-Damage:** Varies with type, 1D4x10 to 4D6x10M.D. See the CS Explosives section in the **Rifts RPG, pg. 204**, for details.

**Maximum Effective Range:** Blast radius is confined to a 10 foot (3.0 m) diameter. Throwing range by a human is 1D6x10 feet (3.0 to 36.5 m) maximum, but add 20 feet (6.1 m) if thrown by the small robot arms. The robot can lob a block up to 250 feet (76.2 m) with the large arms.

In *all* cases, a thrown fusion block is -4 to strike the desired target area (needs a 16 or better to hit an exact location). There is also a chance that the jarring shock of landing will cause the following.

01-20 Explodes exactly as intended.

21-40 Explodes on impact.

41-60 Time is scrambled and it takes twice as long as intended to explode.

61-80 Time is scrambled and it takes half as long as intended to explode.

81-00 Timer stopped. No explosion, but can be retrieved and reset.

**Rate of Fire:** Setting and placing the bomb takes one full melee round (15 seconds). Setting and throwing the block counts as two melee actions.

**Payload:** 10 fusion blocks maximum. In the alternative: 26 hand grenades or blasting caps, or three satchel charges.

**5. Optional Laser Turrets (1 or 2):** An optional weapon system for use by mercenaries and adventurers. Turrets can rotate 90 degrees from side to side and have a 45 degree arc of fire.

**6. Optional Shoulder Mini-Missiles Launchers (2) and/or Back Launcher (1):** Standard mini-missile or short-range missile launchers.

**Primary Purpose:** Defense

**Secondary Purpose:** Anti-Armor/Assault

**Missile Type:** Any mini-missile type can be used. The standard complement of missiles include armor piercing (1D4×10 M.D.), plasma or Heavy-Hitters (1D6×10 M.D.).

**Mega-Damage:** Varies with missile type.

**Maximum Effective Range:** Usually about a mile (1.6km).

**Rate of Fire:** One at a time, or in volleys of two, three or four.

**Payload:** 24 mini-missiles per launcher or 8 for short-range missiles.

**7. Hand to Hand Combat:** The IR-2020 is not designed for combat since it tends to be slow. The following capacities are available to pilots with basic robot combat or piloting skills.

Restrained Punch — 1D6 M.D.

Full Strength Punch — 3D6 M.D.

Power Punch (counts as two attacks) — 1D6×10 M.D.

Pry, Crush or Tear — 2D4 M.D.

Kick — 3D6 M.D.

Leap Kick (counts as two melee attacks) — 5D6 M.D.

Body Flip/Throw — 2D4 M.D.

Body Block/Tackle — 3D6 M.D.

Stomp — 2D4 M.D. against man-sized targets.

Starts with one attack per melee round plus those of the pilot.

+1 additional attack at levels 4, 8, and 12; available only to operators skilled in piloting robots.

---

## IR-2040 Destroyer

---

The IR-2040 Destroyer was developed specifically for use in urban and mountain combat by the military. The robot has mini-missile launchers, forearm lasers, a rail gun and optional hand-held weapons. Like the IR-2020 Wrecker, a pair of small, retractable arms are housed in the center of the chest. They are used for handling explosives, light tasks and fine detail work. One small arm has a built-in laser torch/welder while the other has a computer jack. The bot also has a detachable jet pack to give it hover and limited flight capabilities.

The high mobility is especially important for carrying the battle into the wilderness and mountains inhabited by the hordes of supernatural monsters, oni, and eta wildmen. This also makes the one-man robot especially appealing to mercenaries, warriors and adventurers. It is extremely popular and surprisingly common.

**Model Type:** IR-2040 Destroyer

**Class:** Ground & Air Infantry Assault Robot

**Crew:** One pilot; there is no room for passengers.

**M.D.C. by Location:**

Large Arms (2) — 100 each

Large Hands (2) — 35 each

\* Small Grasping Arms & Hands (2) — 28 each

\* Grenade Storage Compartment (1; hip) — 35

Shoulder Mini-Missile Launchers (2) — 35 each

\* Forearm Lasers (2) — 25 each

Rail Gun (1; heavy or light)

\* Optional Energy Rifle (1) — 50

Legs (2) — 180 each

\* Feet (2) — 50 each

Detachable Jet Backpack — 100

Reinforced Pilot's Compartment — 100

\* Head — 75

\*\* Main Body — 420

\* A single asterisk means the item is a small or difficult target to strike and requires the attacker to make a called shot. Each is -3 to strike.

Destroying the head of the robot will eliminate all forms of optical enhancement and sensory systems. The pilot must rely on his own human vision and senses. Any robot bonuses to strike, parry and dodge are lost!

\*\* Depleting the M.D.C. of the main body will shut the bot down completely, rendering it useless.

**Speed:**

**Running:** 60 mph (96.5 km) maximum. Suitable for most terrain including outer space and underwater. Half speed underwater.

**Leaping:** Can leap 10 feet (3.0 m) high or lengthwise from a standing position or 25 feet (7.6 m) high or lengthwise with a short running start.

**Climbing & Rappelling:** The robot can climb girders, piles of debris, mountain cliffs and rappel up and down steel cables. Base skill proficiency is 75%/60%; add 10% if the pilot also has a climbing skill.

**Flying:** With the detachable backpack, the robot can fly at speeds of 140 mph (224 km) at a maximum altitude of 8000 feet (2438.4 m). It can also hover stationary and help roll with falls or impact (+2).

**Statistical Data:**

**Height:** 16 feet (4.8 m)

**Width:** 5.6 feet (1.7 m)

**Length:** 5 feet (1.5 m)

**Weight:** 8 tons

**Physical Strength:** Large arms and legs are equal to a P.S. of 38, but the small arms are only P.S. 19.

**Maximum Depth Tolerance:** 1500 feet (457 m)

**Cargo:** Small area for the pilot's food rations, body armor, a first-aid kit, rifle and **sidearm**. A refrigerated water dispenser is also standard (6 gallons/22 liters).

**Power System:** Nuclear, with an average energy life of 20 years.

**Market Price:** 12 million credits for a new constructed robot, 7 million for a reconditioned, used bot (has 1D4×10% less M.D.C.); good availability for both. Replacement arms cost 55,000 credits per small one (frequently destroyed in handling explosives) or 155,000 per large one.

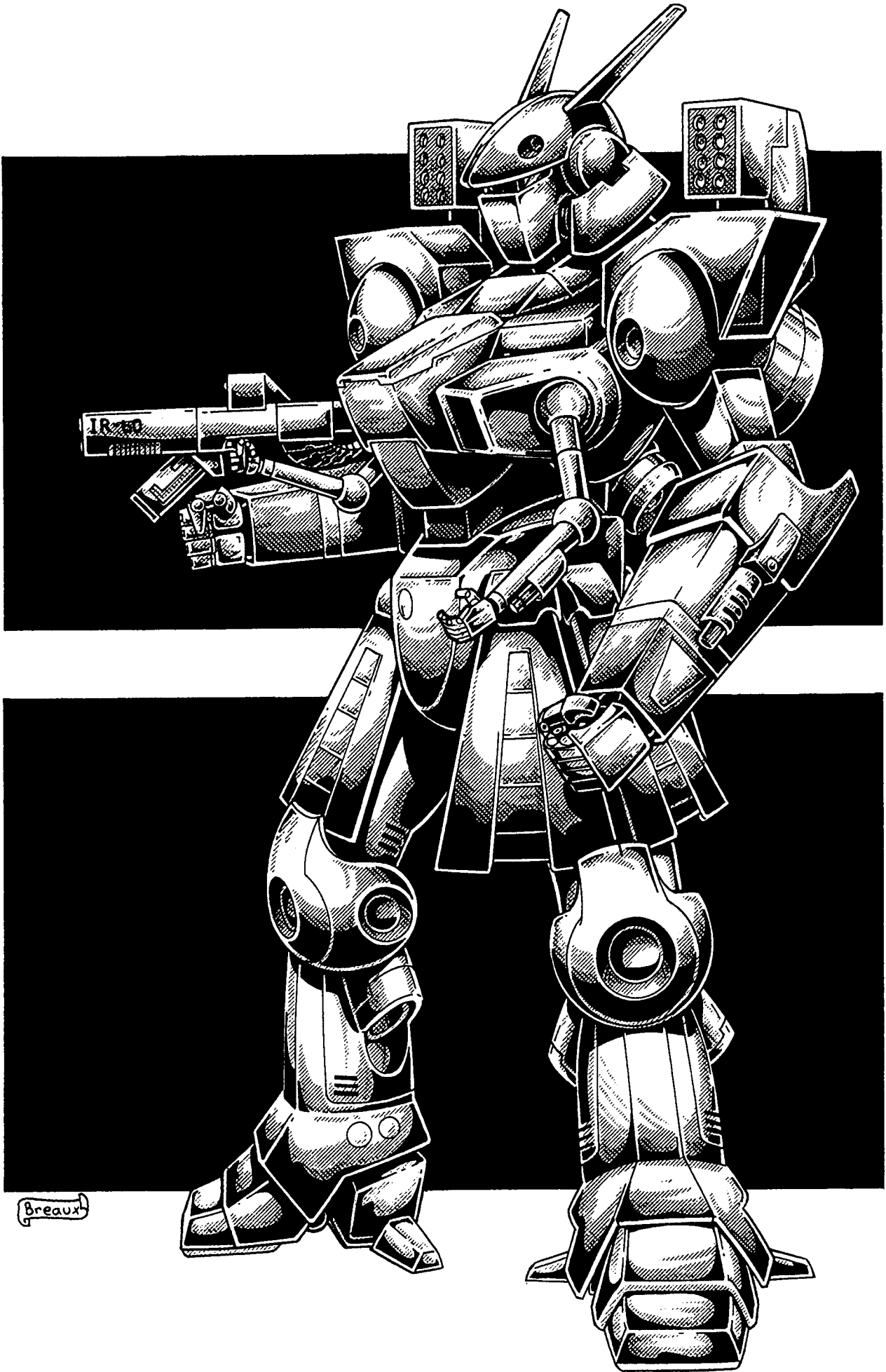

H-Brand is working on a knock-off it plans to call the Warrior, but can't match Ichto's technology. It is likely to have 20% less M.D.C., be 10% slower, have one less attack per melee round, and cost 2 million more. May be out within a year.

## Weapon Systems

**1. Shoulder Mini-Missile Launchers (2):** A small mini-missile launcher is mounted above each shoulder.

Primary Purpose: Assault

Secondary Purpose: Anti-Armor

Missile Type: Any mini-missile type can be used. Standard issue, however, consists of armor piercing (1D4×10 M.D.), plasma or Heavy-Hitters (1D6×10 M.D.) missiles.

Mega-Damage: Varies with missile type.

Maximum Effective Range: Usually about a mile (1.6 km).

Rate of Fire: One at a time, or in volleys of two, three or four.

Payload: 16 total; 8 in each launcher.

**2. IR-60 Rail Gun:** The same rail gun used by the Katanapower armor.

The rail gun is hooked into the robot's nuclear power supply and can be fed by a large ammo drum mounted on the back of the robot (but the pilot cannot use the jet pack) or a smaller ammo drum hooked to the right hip. There is also a reserve clip magazine attached to the rail gun which can be accessed by the flip of a switch. This magazine is usually filled with silver ammunition for use against supernatural opponents.

Weight: 90 pounds (40.8 kg) for the gun, 120 pounds (54 kg) for the ammo-drum.

Primary Purpose: Assault

Mega-Damage: A full damage burst is 40 rounds and inflicts 1D4×10 M.D. At the flip of a switch the weapon can fire 10 shot bursts which inflict 2D6 M.D.

Maximum Effective Range: 4000 feet (1220 m)

Rate of Fire: Equal to the combined hand to hand attacks (usually 4-6).

Payload: 2400 rounds per standard large drum for 60 full strength bursts or 240 short bursts! The small drum has 1200 rounds for 30 full strength bursts or 120 short bursts. The clip magazine holds 200 rounds, equal to 5 full bursts. Reloading a drum will take about 5 minutes for those not trained, but a mere one minute by somebody trained in the use of power armor; a strength of 26 or higher is required.

**3. Forearm Lasers (2):** A high-powered laser is built into the forearm of each of the large arms.

Primary Purpose: Assault

Secondary Purpose: Defense

Mega-Damage: Two settings: 2D6 M.D. and 4D6 M.D. per single blast or 4D6M.D. or 8D6 M.D. per simultaneous double blast.

Maximum Effective Range: 2000 feet (610 m)

Rate of Fire: Equal to the combined number of hand to hand attacks (usually 4-6).

Payload: Effectively unlimited.

**4. Laser Torch in the Small Arm (1):** A precision laser torch is built into the forearm of one of the small grasping arms, usually the right one. In addition to construction use, the laser can be used in short-range combat. **Note:** The small arms with their fully articulated, human-like hands can also wield pistols, rifles, swords, clubs and tools. The left arm has a computer jack for linking with computer systems and heavy equipment.

Primary Purpose: Cutting and welding tool.

Secondary Purpose: Defense

Mega-Damage: Four settings: 3D6 S.D.C., 1D6×10 S.D.C., 1D6 M.D. and 2D6 M.D. per blast.

Maximum Effective Range: 200 feet (61.0 m)

Rate of Fire: Equal to the combined number of hand to hand attacks (usually 4-6).

Payload: Effectively unlimited.

**5. Grenade Storage Compartment (1):** A small compartment is located on the robot's hip that contains hand grenades.

Primary Purpose: Assault.

Mega-Damage: Varies with type, typically 2D6 to 5D6 M.D., or can include smoke, stun and tear gas types.

Maximum Effective Range: 120 feet (36.5 m) when thrown by humans or small robot arms, but the large arms can lob a grenade 300 feet (91.5 m); -1 to strike.

Rate of Fire: Each throw counts as one melee action/attack.

Payload: 10 hand grenades or one satchel charge and two grenades.

**6. Optional Rifle and Sidearms:** The robot's small arms can also use energy rifles, pistols, vibro-blades or other conventional weapons.

**7. Hand to Hand Combat:** The IR-2040 is designed for combat, so it is quick and capable. Basic piloting skills are the same as those listed in the **Rifts RPG**, but elite piloting offers the following capabilities.

Restrained Punch - 1D4 M.D.

Full Strength Punch - 2D6 M.D.

Power Punch (counts as two attacks) - 1D4×10 M.D.

Kick - 2D6 M.D.

Leap Kick (counts as two melee attacks) - 4D6 M.D.

Body Flip/Throw - 1D6 M.D.

Body Block/Tackle - 2D4 M.D.

Stomp - 1D4 M.D. against man-sized targets.

Starts with two attacks per melee round plus those of the pilot.

+1 additional attacks at levels five, 10, and 15.

+1 on initiative

+1 to strike

+2 to parry

+3 to dodge

+3 to roll with impact or fall.

---

## IR-2050 Apocalypse

---

The IR-2050 Apocalypse is a recent Ichto creation that has entered service only five years ago. Ichto likes to keep this robot in reserve for its own armed forces but does *occasionally* sell them to other kingdoms and even to mercenaries. The **Otomo** Shogunate has 24, **Yukamura** 10, **Toshiie** three and approximately 50 others have been sold to meres and independent forces. Of **course**, this greatly concerns the Republic of Japan who placed trade sanctions against Ichto over this issue. Such sales and sanctions only **enflame** the animosity between these two kingdoms.

The towering, 30 foot (9.1 m) robot is a walking arsenal with the face of a demon. The face was included as a design element to enhance the bot's horrific appearance and to mock the oni it is designed to battle. In addition to missile launchers, lasers, and plasma weapons, the IR-2050 has a pair of weapon arms located below its more human-looking limbs. The weapon arms fire mini-missiles, long-range lasers and possess four wicked blades at the tip for parrying and to slash apart the enemy.

Mounted on the back is what appears to be a pair of wings and a rocket. In reality, this is a remote control, flying robot drone. It can be launched at any time and has VTOL capabilities so it can reconnect with the bigger robot at a later time. The drone is controlled by one of the gunners or co-pilot and can be unleashed to strafe ground troops or to engage aerial opponents. Like the big robot, the drone aircraft has a pair of weapon arms that fire high-powered lasers. It also has four mini-missiles.



**Model Type:** IR-2050 Apocalypse

**Class:** Ground and Air Infantry Assault Robot

**Crew:** 4; pilot, co-pilot/communications officer, and two gunners; one for each weapon arm and to pilot the remote control drone.

**M.D.C. by Location:**

Legs (2) — 300 each

Feet (2) — 150 each

\* Hands (2) — 90 each

Arms (2; human-like) — 200 each

\* Forearm lasers (2; one per arm) — 50 each

Weapon Arms (2; additional arms) — 200 each

\* Weapon Arm Blades (8; four per arm) — 70 each

Medium-Range Shoulder Missile Launchers (2) — 120 each

\* Concealed Chest Mini-Missile Launchers (4) — 30 each

\* Leg Mini-Missile Launchers (4; two per leg) — 80 each

Reinforced Pilot's Compartment — 200

\* Belly Plasma Ejector (1) — 100

\* Belly Rail Gun (1) — 100

Robot Drone Aircraft (1) — 110

\*\* Head — 200

\*\*\* Main Body — 625

\* A single asterisk means the item is a small or difficult target to strike and requires the attacker to make a called shot. Each is -3 to strike.

\*\*Destroying the head of the robot will eliminate all forms of optical enhancement and sensory systems. The pilot must rely on his own human vision and senses. Any robot bonuses to strike, parry and dodge are lost!

\*\*\* Depleting the M.D.C. of the main body will shut the bot down completely, rendering it useless.

**Speed:**

**Running:** 40 mph (64 km) maximum. Cruising speed is usually around 20 mph (32 km). Suitable for most terrain, including outer space and underwater, but swimming and walking speed are reduced by half.

**Leaping:** Not possible.

**Flying:** Not possible.

**Statistical Data:**

**Height:** 35 feet (10.7 m) from head to toe, 40 feet (12.2 m) including the shoulder mounted missile launchers.

**Width:** 14 feet (4.3 m)

**Length:** 6 feet, 8 inches (2.0 m)

**Weight:** 50 tons

**Physical Strength:** Equal to a P.S. of 50.

**Maximum Depth Tolerance:** 1500 feet (457 m)

**Cargo:** None.

**Power System:** Nuclear, average energy life is 20 years.

**Market Price:** 68 million credits for a new robot with complete weapon systems. The Apocalypse is rarely available on the open market and is only available from the **Ichto** Robotics Corporation. Replacement aerial drones cost one million credits.

## Weapon Systems

**1. Medium-Range Missile Launchers (2):** A medium-range missile launcher is mounted above each shoulder of the robot. In most cases, the co-pilot fires these missiles.

**Primary Purpose:** Assault

**Secondary Purpose:** Anti-Armor/Anti-Aircraft

**Missile Type:** Any medium-range missile can be fired. Heavy-Hitters (3D4x10 M.D.), high explosive or plasma (2D6x10 M.D. each) missiles are the standard issue. Fragmentation (2D4x10 M.D.) missiles will be used against predominantly infantry units.

**Mega-Damage:** Varies with missile type.

**Maximum Effective Range:** Varies with missile type.

**Rate of Fire:** One at a time, or in volleys of two, four and eight

**Payload:** 8; four in each launcher.

**2. Chest Mini-Missile Launchers (4):** Multiple shot mini-missile launchers are concealed beneath the armor plating of the chest. Before the missiles are fired, a hatch will snap open, revealing the deadly payload. The pilot and/or co-pilot usually controls these missiles.

**Primary Purpose:** Assault

**Secondary Purpose:** Anti-Armor

**Missile Type:** Any mini-missile type can be used. Standard issue, however, consists of armor piercing (1D4x10 M.D.), plasma or Heavy-Hitters (1D6x10 M.D.) missiles.

**Mega-Damage:** Varies with missile type.

**Maximum Effective Range:** Usually about a mile (1.6 km).

**Rate of Fire:** One at a time, or in volleys of two or four.

**Payload:** 40; 10 in each launcher

**3. Forearm Lasers (2):** Mounted on each forearm is a double-barrel, high-powered laser. The pilot controls this weapon; point and shoot.

**Primary Purpose:** Assault

**Secondary Purpose:** Anti-Aircraft and Anti-Missile

**Mega-Damage:** 1D4x10 M.D. per single blast or 2D4x10 M.D. per simultaneous blast from both arms.

**Maximum Effective Range:** 2000 feet (610 m).

**Rate of Fire:** Equal to that of the pilot.

**Payload:** Effectively unlimited.

**4. Belly Rail Gun (1):** A rail gun is built into the lower abdomen of the robot. It can rotate 90 degrees in any direction. Silver ammunition can be used instead of the standard ammunition listed below.

**Primary Purpose:** Anti-Personnel

**Secondary Purpose:** Assault

**Mega-Damage:** A burst is 60 rounds and inflicts 2D4x10 M.D.

**Maximum Effective Range:** 6000 feet (1830 m)

**Rate of Fire:** Bursts or Wild fire only.

**Payload:** An internal 12,000 round ammunition drum for a total of 200 bursts! It takes specialized equipment, a trained crew of technicians and several minutes to reload the ammo drum.

**5. Plasma Belly Gun:** A powerful plasma ejector is located in the belly area of the robot. The gun can swivel 90 degrees in any direction.

Operated by the co-pilot or one of the gunners.

**Primary Purpose:** Assault

**Secondary Purpose:** Anti-Supernatural Beings

**Mega-Damage:** 1D6x10 M.D. per blast.

**Maximum Effective Range:** 1600 feet (487.6 m)

**Rate of Fire:** Equal to the combined number of hand to hand attacks of the gunner (usually 4-6).

**Payload:** Effectively unlimited.

**6. Leg Mini-Missile Launchers (4):** On the side of each hip are two mini-missile launchers. These missiles are launched by the gunners.

**Primary Purpose:** Anti-Personnel

**Secondary Purpose:** Assault

**Missile Type:** Any mini-missile type can be fired. Fragmentation missiles (5D6 M.D.) are the standard load though.

**Mega-Damage:** Varies with missile type.

**Maximum Effective Range:** Usually about one mile (1.6 km).

**Rate of Fire:** One at a time, or in volleys of two or five.

**Payload:** 40; 10 per each launcher.

**7. Main Weapon Arms (2):** A second pair of devastating weapon arms are located under the large, human-like arms. Each is operated by

a gunner and can fire a long-range, high-powered laser and short-range missiles. In addition, four large, M.D. blades protrude beyond the gun barrel and launch tube for close combat.

**Short-Range Missile Launchers (1 per weapon arm):** A short-range missile launcher, holding eight shots, is located in each arm.

Primary Purpose: Anti-Personnel/Assault

Secondary Purpose: Anti-Armor

Missile Type: Any short-range missile can be used but plasma (2D6×10 M.D.) and armor piercing missiles (1D6×10 M.D.) are the most often used.

Mega-Damage: Varies with missile type.

Maximum Effective Range: Typically four miles (6.4 km).

Rate of Fire: One at a time, or in volleys of two or four.

Payload: 16; eight in each arm.

**High-Powered Laser Cannon (1 per weapon arm):**

Primary Purpose: Assault

Secondary Purpose: Anti-Aircraft and Anti-Missile

Mega-Damage: 1D4×10 M.D. per single blast or 2D4×10 M.D. per simultaneous blasts from both arms.

Maximum Effective Range: 6000 feet (1830m).

Rate of Fire: Equal to that of the gunner.

Payload: Effectively unlimited.

**Four Pronged Blades:** For hand to hand.

Mega-Damage:

4D6 M.D. from a slash attack

6D6 M.D. stab attack

1D6×10 M.D. Power Stab (counts as two attacks).

**8. Hand to Hand Combat:** Rather than use a weapon, the pilot can engage in mega-damage hand to hand combat. See Basic Robot Combat Training in the **Rifts RPG**, page 44. Special Training in piloting the IR-2050 provides the following:

Restrained Punch — 2D6 M.D.

Full Strength Punch — 4D6 M.D.

Power Punch (counts as two attacks) - 8D6 M.D.

Blade Slash Attack — 4D6 M.D.

Blade Stab Attack — 6D6 M.D.

Blade Power Stab — 1D6×10 M.D. (counts as two attacks).

Crush, Pry or Tear — 2D6 M.D.

Kick — 4D6 M.D. (leap kick not possible)

Body Flip/Throw - 2D6 M.D.

Body Block/Tackle - 5D6 M.D.

Stomp - 2D4 M.D. against man-sized targets.

**9. Sensor Systems of Note:**

1. Full optical systems, including laser targeting, telescopic, passive night vision (light amplification), **thermo-imaging**, infrared, ultraviolet, and polarization. Plus all other features common to most robots.

2. Long-range radar and radio communications. Independent drone control and tracking system.

## The Unmanned Drone Aircraft

**Class:** Remote Control Aerial Combat Drone.

**M.D.C. by Location:**

Wings (2) — 75 each

Jet Thrusters (3) — 40 each

Weapon Arms (2) — 35 each

Main Body — 110; considered to be disposable.

Maximum Flying Speed: 250 mph (400 km); VTOL capable.

Effective Range: 50 miles (80 km) before radio control becomes dangerously weak and susceptible to jamming. Ideal range is within 5 miles (8 km) of the IR-2050. Can fly and engage in combat for seven hours before it loses power.

Bonuses: Only +2 to dodge and those of the remote control operator; do not include the bonuses from the robot piloting skill.

Height: 10 feet (3 m); diameter of the body.

Width: Wings Fully Extended: 25 feet (7.6 m)

Length: 20 feet (6 m)

Weight: 4 tons

Physical Strength: Weapon arms P.S. 20.

Cargo: None.

Power System: Power cells that require recharging.

Market Price: One million credits, considered disposable.

Weapon Systems of the Drone:

**1. Weapon Arms:** A pair of small weapon arms are located on the underside of the drone. They can fire independently or simultaneously at the same target or at two different targets (-1 to strike in the latter instance). Each can rotate 360 degrees and has a 100 degree arc of fire.

Primary Purpose: Assault and Anti-aircraft

Secondary Purpose: Reconnaissance

Mega-Damage: 1D4×10+8 M.D. per single blast or 4D6×10 per double blast at the same target.

Maximum Effective Range: 300 feet (91.4 m)

Rate of Fire: Equal to the number of hand to hand attacks of the operator of the remote control, +2 attacks per melee round.

Payload: 200 blasts; 100 per arm before requiring recharging. To recharge, the drone must be reattached to the back of the IR-2050 (or similar power supply) where it draws on the big bot's energy supply.

**2. Mini-Missiles:** Attached to the underside of each wing are two mini-missiles.

Mega-Damage: 1D4×10 M.D. each

Maximum Effective Range: One mile (1.6 km)

Rate of Fire: One or two at a time.

Payload: Four mini-missiles.

---

## IR-2060 Banshee

---

The Banshee was developed specifically for combat in the campaign to reclaim The Zone by other kingdoms. It has only been in service for two years, but has been involved in dozens of military operations. Response from pilots has, thus far, been overwhelmingly positive, the robot is "durable as all hell and packs a nasty wallop," is a common catch-phrase.

The sleek design of the bot actually evolved around the main gun for the Banshee, an incredibly powerful sonic cannon prototype that is attached to the front side of the right or left shoulder and can be locked in an upward or forward position. It also has a pair of retractable vibro-blades, a light wrist laser, clawed fingers, and mini-missiles mounted on the wings. It can also use oversized borg energy rifles, rail guns and other hand-held weapons if desired.

For a robot vehicle, the Banshee is surprisingly quick and agile in the air and on the ground. The robot's versatility makes it excellent as a support weapon for power armor and infantry units as well as to engage in reconnaissance, search and destroy, rescue operations, strategic strikes, and urban combat. The Banshee is quickly becoming the work-horse of the **Otomo** Shogunate who has purchased 244 bots (along with 800 Super Tengu and 400 Tazu Tengu) and is incredibly popular among mercenaries and eta.

The Banshee has metallic wings like the Tengu power armor, but all similarities end there. The body of the robot is much bulkier and a pair of large jet **thrusters** protrude from its back. It also has **thrusters** in the feet and several, tiny maneuvering jets are strategically located on the



body. Rather than a bird-like head, the robot has a somewhat skull-like head.

This is another of Ichto's creations that has put a serious strain on its relationship with the Republic of Japan. **Armotech** believes the Banshee was created specifically to support the Tazu-Tengu and Super Tengu power armor, and to counter the Armotech SAMAS power armor and fighter aircraft. And to give **Ichto** air superiority (an arguable point, as the Republic remains a powerhouse in the air and on the ground — tiny Ichto just doesn't have the resources of the new Japanese nation, although it does wield a disproportionate amount of power for its size). The fact that the robot is sold on the mass market to whomever can afford one causes tremendous consternation and concerns to the Republic (and to the New Empire). The Republic of Japan has demanded that Ichto restrict the sale of the robot, but the Province has refused and recently lowered the price of the Banshee and the Tengu by 10% (the prices in this book represent the lowered prices). **Note:** In addition to being available to adventurers, mercenaries and the wealthy, the Banshee and two Tengu power armor suits have fallen into the hands of criminals, bandits, and pirates. Two different factions of **Horune** pirates have recently added both the Tazu-Tengu and Banshee to their arsenal. The flying machines have proven to be wonderful for reconnaissance at sea, waging surprise attacks and boarding ships.

**Model Type:** IR-2060 Banshee

**Class:** Ground & Air Infantry Assault Robot

**Crew:** Two; pilot and co-pilot/gunner; there is no room for passengers.

**M.D.C. by Location:**

Hands (2) — 60 each

Arms (2) — 140 each

Forearm Vibro-Swords (2) — 50 each

Legs (2) — 230 each

Feet/Thrusters (2) — 75 each

Main Jet Thrusters (2; back) — 110 each

Maneuvering Thrusters (10) — 15 each

\* Wings (2) — 220 each

Mini-Missile Launchers (2; wings) — 90 each

Sonic Cannon — 155

Reinforced Pilot's Compartment — 120

\*\* Head — 120

\*\*\* Main Body — 400

\* Destroying one wing means the Banshee can no longer fly. However, jet propelled leaps and low altitude hovering (100 feet/30.5 m) are possible. Destroying the main **thrusters** will reduce speed by 50%! Destroying maneuvering jets reduces aerial maneuvers by 3% per each one destroyed. Destroying the feet reduces speed and maneuvering by 30%.

\*\* Destroying the head of the robot will eliminate all forms of optical enhancement and sensory systems. The pilot must rely on his own human vision and senses. Any robot bonuses to strike, parry and dodge are lost!

The head is a comparatively small and difficult target to hit. Thus, it can only be hit when an attacker makes a called shot, but even then the opponent is -3 to strike. The hands, feet, forearm weapons, and maneuvering thrusters are also just as difficult to hit.

\*\*\* Depleting the M.D.C. of the main body will shut the **bot** down completely, rendering it useless.

**Speed:**

**Running:** 60 mph (96 km) maximum. Cruising speed is considered to be around 25 mph (40 km). Suitable for most terrain, including outer space and underwater, but speed is half underwater.

**Leaping:** Can leap up to 15 feet (4.6 m) high or lengthwise unassisted by the thrusters. A jet assisted leap propels the unit up to 100 feet (30.5 m) high and 150 feet (45 m) lengthwise.

**Flying:** The Banshee's rocket propulsion system enables it to hover stationary or fly. Maximum flying speed is 260 mph (416 km), but cruising speed is considered to be around 100 mph (160 km). Gliding speed is around 60 mph (96 km). Maximum altitude is limited to about 6000 feet (1828 m). Maximum speed underwater is 40 mph (64.3 km).

**Flying Range:** The robot has years of life, but the **thruster** jets need to cool after a maximum of 10 hours of flight when travelling at speeds above cruising or twenty-four hours of continuous flight at cruising speed. However, with periodic stops and rest of 30 to 60 minutes, the thrusters can function indefinitely.

**Maximum Depth Tolerance:** 2000 feet (610 m)

**Statistical Data:**

**Height:** 17 feet, 8 inches (5.4 m)

**Width:** 7 feet (2.1 m) from shoulder to shoulder.

**Wings Down:** 10 feet (.03 m)

**Wings Fully Extended:** 30 feet (.19 m)

**Length:** 5 feet, 4 inches (1.6 m) without the shoulder cannon, 9 feet (2.7 m) including the sonic cannon.

**Weight:** 22 tons

**Physical Strength:** Equal to a P.S. of 40.

**Cargo:** Only a small area for the crew's personal belongings and a pair of light body armor suits.

**Power System:** Nuclear, with an average energy life of 20 years.

**Market Price:** 28 million credits for a brand new, fully charged robot with complete weapon systems; missiles included. Fair to good availability. The robot is popular among security forces, mercenaries, adventurers and even ordinary (but wealthy) people. It is a major part of the defenses in the Ichto Province and **Otomo** Shogunate as well as other kingdoms. The Banshee is illegal in the Republic of Japan.

## Weapon Systems

**1. Sonic Cannon:** A large sonic cannon is mounted above the right shoulder, a marvel of technology which survived the coming of the Rifts. The weapon, which is hooked into the robot's nuclear power supply, fires a concentrated blast of sonic energy. Although the weapon does make a considerable amount of noise, only the target is adversely affected by the blast.

**Primary Purpose:** Assault

**Secondary Purpose:** Anti-Personnel

**Mega-Damage:** 1D6×10 M.D. per blast, plus 3D6 M.D. to a 10 foot diameter around the blast area. Double damage and range underwater.

**Maximum Effective Range:** 2000 feet (610 m)

**Rate of Fire:** Equal to the combined number of hand to hand attacks (usually 4-6).

**Payload:** Effectively unlimited.

**2. Wing Mini-Missile Launchers (2):** Hooked to the armature of each wing is a mini-missile launcher.

**Primary Purpose:** Anti-Aircraft and Anti-Missile.

**Secondary Purpose:** Assault

**Missile Type:** Any mini-missile can be fired. The standard complement, however, consists of an even mix of 10 fragmentation (5D6 M.D.) and 10 plasma (1D6×10 M.D.) missiles.

**Mega-Damage:** Varies with missile type.

**Maximum Effective Range:** Usually about one mile (1.6 km).

**Rate of Fire:** One at a time, or in volleys of two, four or five.

**Payload:** 20; 10 missiles in each launcher.

**3. Light Wrist Laser (2):** In the wrist area of each forearm is a blue-green laser. The pilot simply raises the hand, points and shoots.

**Primary Purpose:** Defense

**Secondary Purpose:** Assault

**Mega-Damage:** 3D6 M.D. per blast



Maximum Effective Range: 2000 feet (610 m)

Rate of Fire: Equal to the combined number of hand to hand attacks (usually 4-6).

Payload: Effectively unlimited.

**4. Forearm Vibro-Swords (2):** Five foot (1.5 m) long, retractable vibro-swords are housed in the forearms of the robot.

Mega-Damage: 5D6 M.D.

**5. Hand to Hand Combat:** See Basic Robot Combat Training in the **Rifts RPG**, page 44, for general piloting bonuses, but Special Training in piloting the **IR-2060** provides the following:

Damage & Bonuses from Banshee Combat Training:

Restrained **Claw Strike** — 1D6 M.D.

Full Strength **Claw Strike** — 3D6 M.D.

Power **Claw Strike** — 1D4x10M.D. (counts as two attacks)

Crush, Pry or Tear — 3D6 M.D.

Kick — 3D6 M.D.

Leap Kick — 1D4x10M.D. (counts as two attacks)

Body **Flip/Throw** — 1D6 M.D.

Body **Block/Tackle** — 3D6 M.D.

Stomp — 1D6 M.D. to man-sized targets.

+1 on initiative

+1 to strike

+1 to parry

+2 to dodge; +4 to dodge when flying.

+3 to pull punch

+2 to roll with fall or impact

Starts with two melee round attacks plus those of the pilot.

+1 additional melee attack at levels **five** and **ten**.

**6. Sensor Systems of Note:** All the basic robot systems plus sonar.

when within 100 feet (30.5 m), 30% chance within 200 feet (61 m), 10% chance within 300 feet (91.5 m) or beyond. It is virtually invisible to fast moving (100+ mph) aircraft even when flying at tree-top level. Reduce range by half when underwater.

**Note:** Add +15% to being seen by the naked eye when the bot is moving, fighting or in smoke or grit filled air — the sound of movement, fighting, and movement of vegetation and objects as the bot passes by them helps to reveal its nature and location. Add an additional +10% at night, because the blurred outline of the cloaked robot tends to shimmer at night when it moves, like waves rippling across an otherwise quiet pond (no night penalty when standing motionless). It is also vulnerable to infrared and **thermo-imaging**, motion detection, and sonar, plus other problems may arise. However, against many of the supernatural monsters that plague the islands, the cloaked Gemini is beyond detection except at close range.

**Model Type:** IR-2070 Gemini

**Class:** Ground Infantry Assault Robot

**Crew:** One pilot and a gunner or co-pilot, with room for one additional passenger.

**M.D.C. by Location:**

\* Hands (2) — 90 each

**Arms (2) — 180 each**

Legs (2) — 230 each

**\* Feet (2) — 100 each**

Shoulder Mini-Missile Launchers (2) — 80 each

\* Forearm Laser (1; right arm) — 100

\* Forearm **Vibro-Blade** (1; left arm) — 70

Optional Rail Gun (1) — 100

Reinforced Pilot's Compartment — 180

**\*\* Head — 140**

**\*\*\* Main Body — 500**

\* A single asterisk means the item is a small or difficult target to strike and requires the attacker to make a called shot. Each is -3 to strike.

\*\* Destroying the head of the robot will eliminate all forms of optical enhancement and sensory systems. The pilot must rely on his own human vision and senses. Any robot bonuses to strike, parry and dodge are lost!

\*\*\* Depleting the M.D.C. of the main body will shut the bot down completely, rendering it useless.

**Speed:**

Running: 50 mph (80 km) maximum. Cruising speed is considered to be around 25 mph (40 km). Suitable for most terrain, including outer space and underwater; half speed underwater.

Leaping: The robot legs can reach a height of 10 feet (3.0 m) or a distance of 15 feet (4.6 m) lengthwise. With a short running start the bot can double the leaping distance.

Flying: Not possible.

**Statistical Data:**

Height: 21 feet, 8 inches (6.6 m)

Width: 8 feet (2.4 m)

Length: 5 feet, 4 inches (1.6 m)

Weight: 23 tons

Physical Strength: Equal to a P.S. of 45.

Cargo: None.

Power System: Nuclear, with an average energy life of 6 years.

Black Market Price: Not available on the black market. If a prototype somehow found its way onto the illegal market it would retail for 50 million credits or **more!**

---

## IR-2070 Gemini

---

One of latest **Ichto** robots is the IR-2070 Gemini prototype which hasn't yet finished its testing period. Twenty-four are currently being field tested by the **Ichto** Defense Force and a dozen have been sold to known **meres** active in **The Zone** for their use under real combat conditions.

The robot is called the Gemini because it has two faces, the visible visage of a combat bot and an invisible blur! A revolutionary new cloaking device has been installed in the Gemini robot. Special materials have been bonded to the armor plating on a molecular level that allow the Gemini to bend light, making itself virtually invisible! For infiltration behind enemy lines, rescue operations or prisoner snatch operations, the Gemini is proving to be an excellent choice. It also excels at search and destroy operations and can penetrate enemy territory, and call in artillery or aircraft support to destroy the enemy units while the pilot stays safely cloaked behind the scene.

To help its concealment, the body is designed to be low profile with no sharp angles, spikes or protruding weapons that could get caught on vegetation or get in the way. The Gemini is a large bot to accommodate a powerful generator.

As exciting as the cloaking system is, it has its problems. The system draws massive amounts of energy which reduces the range and damage of energy weapons by 50% when the cloak is activated. Furthermore, it reduces the life of the power system from an average of 20 years to about six. Additionally, the cloak system fails when the armor of the main body has lost 70% of its M.D.C. Nor is the cloak of invisibility 100%. When the cloaking system is engaged there is still a 10% chance of locating the robot on radar and there is a distortion area like a blurry silhouette of the bot which can be seen by the naked eye. This is especially true in close combat: 60% of robot being seen and attacked

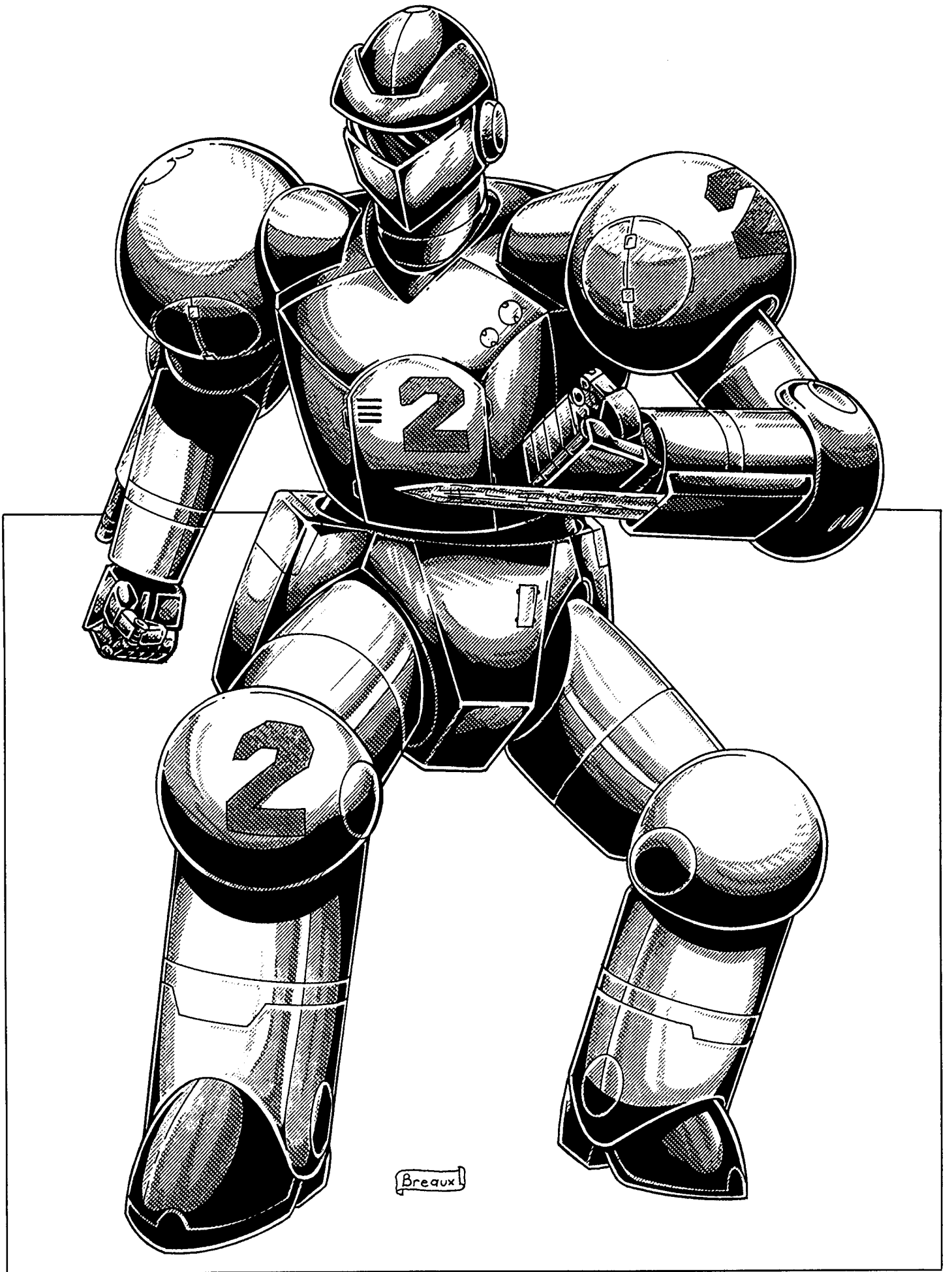

## Weapon Systems

**1. Shoulder Mini-Missile Launchers (2):** A small mini-missile launcher is located in each shoulder of the robot.

Primary Purpose: Anti-Aircraft

Secondary Purpose: Assault

Missile Type: Any mini-missile type can be used. The standard load is either armor piercing (1D4×10 M.D.) or plasma (1D6×10 M.D.) heat-seeking missiles.

Mega-Damage: Varies with missile type.

Maximum Effective Range: Usually about one mile (1.6 km).

Rate of Fire: One at a time, or in volleys of two, three or four.

Payload: 24; twelve in each launcher.

**2. Forearm Laser:** Mounted on the right arm is a high-powered laser.

Primary Purpose: Assault/Anti-Armor

Secondary Purpose: Anti-Aircraft

Mega-Damage: 5D6 M.D. per blast; half when cloaked.

Maximum Effective Range: 3000 feet (910 m); half when cloaked.

Rate of Fire: Equal to the combined number of hand to hand attacks (usually 4-6)

Payload: Effectively unlimited.

**3. Forearm Vibro-Sword (1):** A retractable, five foot (1.5 m) long vibro-sword is housed in the left forearm.

Mega-Damage: 5D6 M.D.

**4. Optional IR-120 Rail Gun:** A giant version of the IR-60 rail gun used by the Katana power armor. It has been created as an alternative to energy weapons that are drained by the cloaking device. The rail gun has its own portable generator attached to the ammo drum. Silver coated ammunition may be provided for use against supernatural opponents.

Weight: 290 pounds (130 kg) for the gun, 600 pounds (270 kg) for the ammo-drum and generator unit which attach to the back of the bot.

Primary Purpose: Assault

Mega-Damage: A full damage burst is 60 rounds and inflicts 1D6×10 M.D. At the flip of a switch the weapon can fire 10 shot bursts which inflict 2D6 M.D.

Maximum Effective Range: 7000 feet (2133 m)

Rate of Fire: Equal to the combined hand to hand attacks (usually 4-6).

Payload: 24,000 round per standard large drum for 400 full strength bursts or 2400 short bursts! Reloading a drum will take about 5 minutes for those not trained, but a mere one minute by somebody trained in the use of power armor; a strength of 26 or higher is required.

Cloaking Glitch: Every time the rail gun is fired, the electro-magnetic pulse causes the invisibility to blink off for two seconds. This blinking off and on obviously reveals the bot's position, although it can have an eerie effect. Other problems may also appear with this experimental, giant rail gun.

**5. Hand to Hand Combat:** Rather than use a weapon, the pilot can engage in mega-damage hand to hand combat. See Basic Robot Combat Training in the **Rifts RPG**, page 44, for rudimentary piloting bonuses. Specific training provides the following:

Damage & Bonuses from Gemini Combat Training:

Restrained Punch — 1D4 M.D.

Full Strength Punch — 2D6 M.D.

Power Punch (counts as two attacks) - 4D6 M.D.

Crush, Pry or Tear — 1D6 M.D.

Kick — 2D6 M.D.

Leap Kick — 4D6 M.D. (counts as two attacks)

Body Flip/Throw - 1D6 M.D.

Body Block/Tackle - 2D6 M.D.

+2 on initiative when invisible.

+1 to strike

+3 to parry

+1 to dodge, 44 when invisible.

+2 to roll with impact or fall

Starts with two melee round attacks plus those of the pilot.

+1 additional melee attack at levels five and ten.

**6. Sensor Systems:** All standard robot features, plus long-range communications and a self-destruct mechanism to keep the robot out of enemy hands. The explosion is designed to completely atomize the cloaking system and destroy the robot. Does 2D4×10 M.D. to a surrounding 30 foot (9.1 m) radius.

---

## IR-4000 Tatsu “Dragon”

---

The Tatsu (meaning "dragon") is a giant, robot dragon! The mechanical behemoth was inspired by Armatech's dragon-borgs, but always trying to out do their old rivals, Ichto developed a giant robot vehicle that looks like an oriental dragon sheathed in armor! The tatsu is strangely beautiful and terrifying at the same time. It is roughly three times larger than most, real Japanese dragons and dragon borgs, and has gone toe to toe in combat with a great horned dragon! Its body is covered in a combination of small and large overlapping plates that look like huge scales. Spiny ridges help protect the body and three large horns crown the head.

This devastating weapon of destruction is used exclusively by the Ichto Robotics Corporation to defend the province and protect its holdings. Currently, there are only 16 active robots, with four undergoing repairs and 24 more scheduled for production over the next two years (4 others have been destroyed in combat and one is missing in action, presumed destroyed).

**Model Type:** IR-4000 Tatsu

**Class:** Ground Infantry Assault Robot

**Crew:** One pilot, co-pilot/communications/radar operator, and two gunners. One additional passenger can also be accommodated comfortably.

**M.D.C. by Location:**

\* Clawed Hands (2) — 75 each

Front Arms/Legs (2) — 135 each

Rear Legs (2) — 300 each

Rear Feet (2) — 150 each

Tail (1) — 100 per 20 foot (6.1 m) length

\* Chest Spotlights (2) — 15 each

Tail Laser Turret (1) — 65 each

Shoulder Missile Launcher (1) — 300

Snout Mini-Missile Launchers (2; nostrils) — 80 each

\* Plasma Thrower (1; inside mouth) — 20

\* Plasma Cannon (1; inside mouth) — 50

Reinforced Pilot's Compartment — 150

\* Eyes (2; head sensors and optics) — 50 each

\* Horns (3; head) — 90 each

\*\* Head — 300

\*\*\* Main Body (heavy plates) — 1000

\* A single asterisk means the item is a small or difficult target to strike and requires the attacker to make a called shot. Each is -5 to strike.

\*\* Destroying the head of the robot will eliminate all forms of optical enhancement and sensory systems as well as all head attacks (plasma, bite, horns). The pilot must rely on his own human vision and senses. Any robot bonuses to strike, parry and dodge are lost!

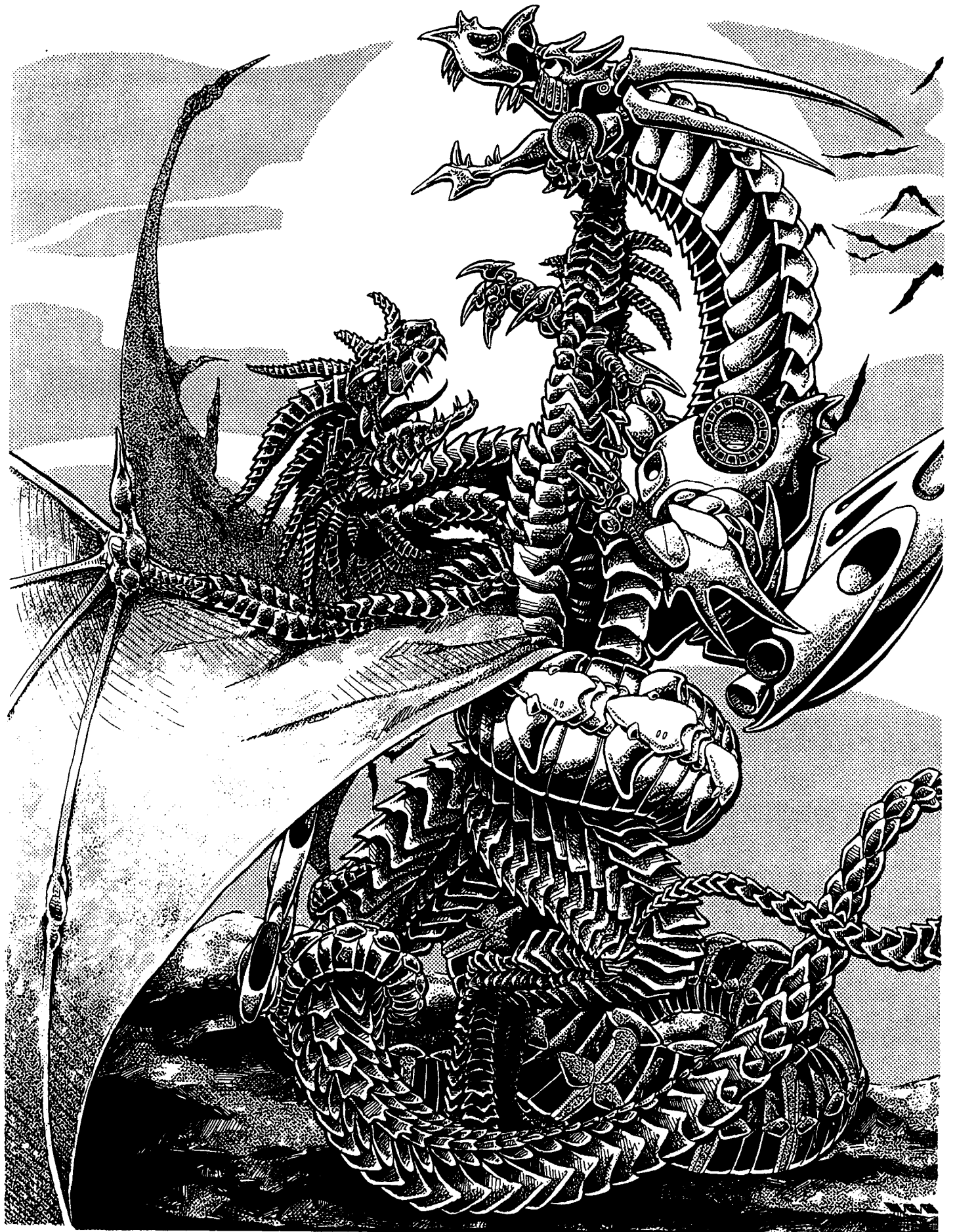

\*\*\* Depleting the M.D.C. of the main body will shut the robot down completely, rendering it useless.

### Speed:

Running: 40 mph (64 km) maximum. Cruising speed is usually around 20 mph (32 km). Suitable for most terrains, including outer space and underwater; half speed underwater.

Leaping: Not possible.

Flying: Not possible.

### Statistical Data:

Height: 20 feet (6.1 m) when standing on all fours, 50 feet (15.2 m) standing erect on rear legs!

Width: 12 feet (3.65m); long and narrow.

Length: The main body, from the tip of the nose to the hind legs is approximately 45 feet (13.7 m). The flexible and prehensile tail adds another 60 feet (18.3 m) for an overall length of 105 feet (32.0 m)!

Weight: 132 tons

Physical Strength: Equal to a P.S. of 50.

Maximum Depth Tolerance (underwater): 2 miles (3.2 km)

Cargo: Small area for the crew to store personal items.

Power System: Nuclear, average energy life is 25 years.

Black Market Price: Not available. Costs 750 million credits to build each one.

## Weapon Systems

**1. Plasma Mouth Weapons:** Inside the mouth is a plasma thrower for close-range attacks and a plasma cannon for long-range combat.

**Mouth Plasma Thrower (1):** A heavy-duty flamethrower is built into the mouth of the dragon. The robot simply opens its mouth and breathes flame.

Primary Purpose: Anti-Monster

Secondary Purpose: Anti-Personnel

Mega-Damage: 3D6 M.D. per single blast of napalm-like fire. Plus there is a 01-90% likelihood of setting all combustible material, including fuel, wood, dry grass, clothes and body hair, on fire. The fire does an additional 1D4 M.D. per melee round and burns for a minimum of 2D4 minutes.

Maximum Effective Range: 200 feet (61.0 m)

Rate of Fire: Equal to the number of combined hand to hand attacks (usually 4-6).

Payload: A total of 50 blasts.

**Plasma Cannon (1):** Also inside the mouth is a powerful plasma cannon. The long, flexible neck enables the head to twist, look and fire in all directions. To shoot, the operator simply looks, opens the mouth and fires. Operated by the pilot or the co-pilot.

Primary Purpose: Defense

Secondary Purpose: Assault

Mega-Damage: 1D4×10M.D. per blast.

Maximum Effective Range: 1600 feet (487 m)

Rate of Fire: Equal to the combined number of hand to hand attacks of the operator (usually 4-6).

Payload: Effectively unlimited.

**2. Snout Mini-missile Launchers (2):** Each nostril of the robot is actually a mini-missile launcher! Can be fired by the pilot, co-pilot or gunner.

Primary Purpose: Defense

Secondary Purpose: Anti-Armor/Assault

Missile Type: Any mini-missile type can be used. The standard complement of missiles include armor piercing (1D4×10 M.D.), plasma or Heavy-Hitters (1D6×10M.D.).

Mega-Damage: Varies with missile type.

Maximum Effective Range: Usually about a mile (1.6 km).

Rate of Fire: One at a time, or in volleys of two, three or four.

Payload: 24; 12in each launcher.

**3. Biting Head & Horns:** The head of the dragon is equipped with a powerful biting jaw and fangs.

A trio of horns, one on the top of the head and two on the sides, are used for stabbing, slashing and parrying. Each can rotate 180-degrees to point completely forward, upward or back.

Mega-Damage:

Bite: 4D6 M.D.

Power Bite: 1D6×10 (counts as two melee attacks)

Impaling horns: 6D6 M.D. and +2 to parry.

Head Butt (without horns): 2D6 M.D.

**4. Palm Lasers (2):** Located in the palm of each hand is a laser blaster.

The pilot needs only to point and shoot.

Primary Purpose: Defense

Secondary Purpose: Assault

Mega-Damage: 2D6 M.D. per single blast or 4D6 M.D. per simultaneous blasts.

Maximum Effective Range: 2000 feet (610 m)

Rate of Fire: Equal to the combined number of hand to hand attacks of the pilot or co-pilot (usually 4-6).

Payload: Effectively unlimited.

**5. Shoulder Missile Launcher:** This versatile weapon can launch medium or long-range missiles. Typically, only the most devastating missiles are used. Controlled exclusively by the gunners.

Primary Purpose: Anti-Aircraft

Missile Type: Any medium or long-range missile type can be used. The standard load is smart bombs (+5 strike) with plasma (4D6×10 M.D.) or multiple warheads (5D6×10 M.D.).

Mega-Damage: Varies with missile type.

Maximum Effective Range: Varies with missile type.

Rate of Fire: One at a time, or in volleys of two or three.

Payload: 12 total.

Heat-Seeker Bonus: +5 to strike.

**6. Tail Laser:** Located halfway down the tail is a double-barreled laser.

This weapon is controlled exclusively by the gunners and used for easy strikes at enemies from the rear and sides.

Primary Purpose: Defense

Secondary Purpose: Assault

Mega-Damage: 3D6 M.D. per single blast or 6D6 M.D. per simultaneous blasts.

Maximum Effective Range: 2000 feet (610 m)

Rate of Fire: Equal to the combined number of hand to hand attacks of the pilot or co-pilot (usually 4-6).

Payload: Effectively unlimited.

**7. Prehensile Tail:** The long, mechanical tail can be used like a whip to strike at opponents or to entangle them.

P.S. Attribute of Tail: 50

Mega-Damage: 3D6 M.D. per strike

**8. Hand to Hand Combat:** Rather than use a weapon, the pilot can engage in mega-damage hand to hand combat.

Damage & Bonuses from Tatsu Combat Training:

Restrained Punch — 1D6 M.D.

Full Strength Punch/Claw — 3D6 M.D.

Power Punch (counts as two attacks) — 1D4×10M.D.

Crush, Pry or Tear — 2D6 M.D.

Kicks — Not possible

Bite — 4D6 M.D.

Power Bite (counts as two melee attacks) — 1D6×10

Impaling horns — 6D6 M.D.



Head Butt (without horns) — 2D6 M.D.

Body Flip/Throw — 2D4 M.D.

Body Block/Ram/Tackle — 4D6 M.D.

+1 strike with tiny hands.

+2 to strike with head/bite

+2 to strike with tail and weapons.

+2 to parry with horns.

+4 to parry with tail.

+3 to dodge for the head.

+1 to dodge with its entire body.

+2 to roll with impact or fall.

Three attacks per melee round to start, plus those of the pilot! +1 additional attack per round at levels 5, 10, and 15.

**9. Sensor Note:** Full robot sensor array and optics, plus long-range communications, radar and sonar.

---

# Body Armor

---

## Body Armor

AT-A11 Kuru Street Armor	IA-130 Sumo
AT-A14 Trooper	HA-4 & 5 Hiker
AT-A15 Marine	HA-6 & 7 Frontiersman
IA-100 Infiltrator	HA-20 Juicer Environmental Armor

---

A wide variety of environmental body armor is found throughout Japan. Only the most significant models are described below. Others may have different colors, blades, spikes, accents, detailing, and styling (there are hundreds of different helmets — thousands if one includes customization by individuals, including demonic faces, horns, blades, crescents, and other features), but other than the appearance, the helmet and/or armor, most are fundamentally one of a handful of specific types. **Ichto** and **H-Brand** are the primary manufacturers of armor for adventurers and mercenaries. **ArmaTech** only makes body armor for the military, police and security forces in the Republic of Japan.

In addition to those listed here, the basic types known as the Gladiator, Crusader, Urban Warrior, Juicer Assassin armor and the Huntsman, as described in the **Rifts RPG**, are also available.

Air filtration, circulation and cooling systems, temperature control, radiation proofing, and fire resistance are standard features. *All* environmental body armors are contained environmental systems like a space-suit. An independent oxygen supply (which engages as necessary) protects the wearer from gases such as toxic fumes, smoke, riot control agents, chemical weapons and pollution. Only if the armor is breached is the environmental protection compromised; like having a hole blasted through part of it, a cracked helmet, or serious damage.

**Optional damage considerations:** Loss of the environmental containment of body armor *and* power armor is *likely* if the M.D.C. of the main body is reduced by 75% or more. Roll percentile dice for each additional damaging attack or impact when the suit has lost 75% or more of its M.D.C.

**01-60%** means everything is still holding okay. Lucky.

**61-80%** means some systems failure like sensors, communication or special optics, weapons, or internal cooling are out. Stress cracks and other signs of structural strain may appear.

**81-00%** means structural failure! Oxygen is leaking out and fumes, gases, disease, radiation, heat, cold, water, etc., can (and are?) leak in!

When all M.D.C. is depleted, the suit is literally torn or blasted to shreds.

## Most combat style environmental body armors have the following properties:

- A minimum of 50 M.D.C.
- Depth tolerance (underwater): 500 feet (152 m) maximum.
- Complete environmental battle armor suitable for use in all hostile environments, including underwater and outer space.
- Computer controlled life support system.
- Internal cooling and temperature control.
- Artificial air circulation systems, gas filtration, and humidifier.
- Computer controlled, independent oxygen supply and purge system that automatically engages in low oxygen or contaminated air environments. Five hour oxygen supply.
- Insulated, high temperature resistant shielding for up to 300 degrees centigrade. Normal fires do no damage. Nuclear, plasma, and magic fires do full damage.
- Radiation shielded.
- Built-in loudspeaker; 80 decibels.
- Directional, short range radio built into the helmet. Range is 5 miles (8 km). All transmissions are automatically **scrambled/unscrambled** in pre-programmed frequencies for military units.
- Some helmets have a Heads Up Display system (HUD).
- Standard optical enhancements include light filtration and passive **nightvision** (2000 ft/610 m). Many also have telescopic sights (5x to 10x magnification, 6000 ft/1830m range).
- A mini-computer located on the wrist has oxygen level, damage, time, date and compass readouts. The computer is used to adjust the temperature of the suit and to switch between different optics modes.
- Waist and/or shoulder belts for ammo, supplies and equipment. Grenades, pistol holster, and additional pouches can be attached both to the waist and shoulder belts.
- The armor is designed for quick and easy attachment of a jet pack, or other backpacks, directly to the suit.
- Suit-up time: A trained soldier or mercenary can suit-up in environmental armor in one minute! The untrained will take 1D4+1 minutes.

## KM-200 Jet Pack

The **Kiramitsu Motors 200** is a universal jet pack designed to be used with any body armor and is also suitable for most types of light power armor. Fast, reliable and easily maintained, the KM-200 is extremely popular, especially among adventurers, bandits, mercenaries and city rats.

- Maximum Speed: 120 mph (192 km)
- Maximum Range: 360 miles (576 km) for liquid fuel types. Theoretically, a nuclear powered pack should have an unlimited range, but it requires a cooling period for every three hours of use, or risk overheating. When the pack overheats, the inner systems and circuitry are burned out, rendering it useless. For every half hour, after the initial 3 hours of use, there is a **01-50%** chance that the pack will overheat and conk-out.
- Weight: 32 lbs (14.4 kg)
- Length: 2.5 feet (0.75 m)
- M.D.C.: 20
- Engine Type: Electric/rechargeable battery with a 6 hour energy supply, or liquid fuel (20 minutes), or nuclear with a 10 year life.
- Market Cost: 54,000 credits for electric or liquid fuel; 460,000 credits for nuclear.

## KM-250 Underwater Propulsion Pack

Kiramitsu Motors designed this underwater propulsion pack specifically for use underwater by body and power armor operatives. The pack attaches easily to the back of most types of body armor with clamps and/or a magnetic link. In addition to underwater propulsion, the pack provides an additional oxygen supply and is reasonably quiet. The KM-250 is suitable only in underwater environments, it is useless on dry land or in outer space.

- Maximum Speed: 35 mph (56 km) underwater; 30 mph (48 km) riding on the water's surface.

- Maximum Range: 400 miles (640 km) for models using fuel. Other propulsion units are nuclear powered and can run indefinitely.
- An additional oxygen supply: 3 hours.
- Maximum Depth Tolerance: 1200 feet (366 m).
- Weight: 45 lbs (20.25 kg)
- Length: 3.5 feet (1.0 m)
- M.D.C.: 30
- Market Cost: 60,000 credits for fuel powered, 500,000 credits for nuclear powered.

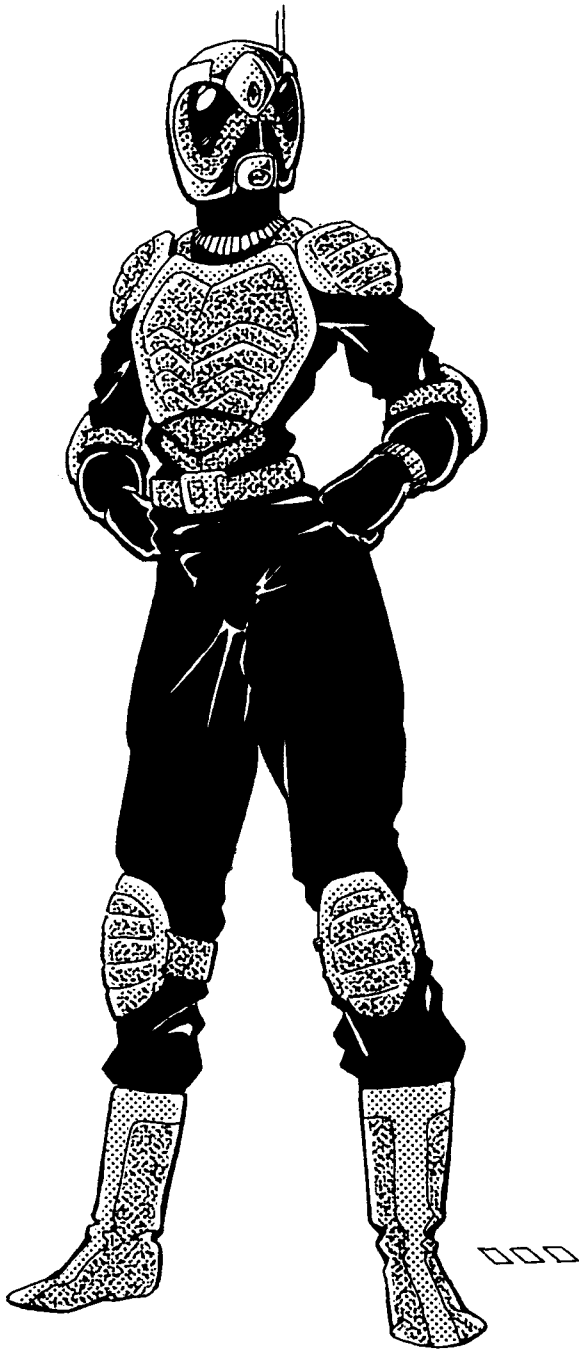

## Republic of Japan

### Military & Police Body Armor

The ArmaTech company holds the exclusive contract for all standard issue body armor of the Armed Forces and police in the Republic of Japan. Each suit of mega-damage armor consists of lightweight padded plates of plastic and metal, bonded on a molecular level, making it stronger than steel.

### AT-A11

### Kuru Street Armor (police)

### Standard for the Republic of Japan Armed Forces

This armor resembles a black cotton jump suit with a high-tech helmet enclosing the head, metal chest plates, guards for the shoulder, elbow and knees, and tight fitting, gauntlet style gloves. The fabric of the jump suit is made of the same lightweight mesh used in the Power-Spy power armor and is stronger than steel.

The armor is standard issue to the police and military Special Forces and special operatives. It has also become a favorite among mercenaries, assassins, and high-tech thieves and criminals. However, it is rarely available through the Black Market or smugglers. It is illegal for ordinary citizens of the Republic of Japan to own any kind of body armor without a special permit and military authorization.

- M.D.C.: 65
- Weight: 15 lbs (6.8 kg)
- Excellent mobility, -5% prowl penalty.
- Market cost: 30,000 credits; 50% more through the underworld.
- Colors: Black, navy blue, and charcoal grey (the latter is usually reserved for civilian security forces). The military also has a white "snow" suit for winter and mountain use. The police armor is always black.

**Knock-off Note:** H-Brand and Ichto make a similar style of suit for ninja, ninja juicers, ninja crazies and spies.

- M.D.C.: 50 to 75 depending on styling and the amount of plating. See the ninja crazy and ninja juicer O.C.C.s for examples of additional styling.
- Weight: 20 lbs (9 kg)
- Good mobility, -10 prowl penalty.
- Market cost: 35,000 to 40,000 credits.
- Colors: Black, white or a dark, blood red.

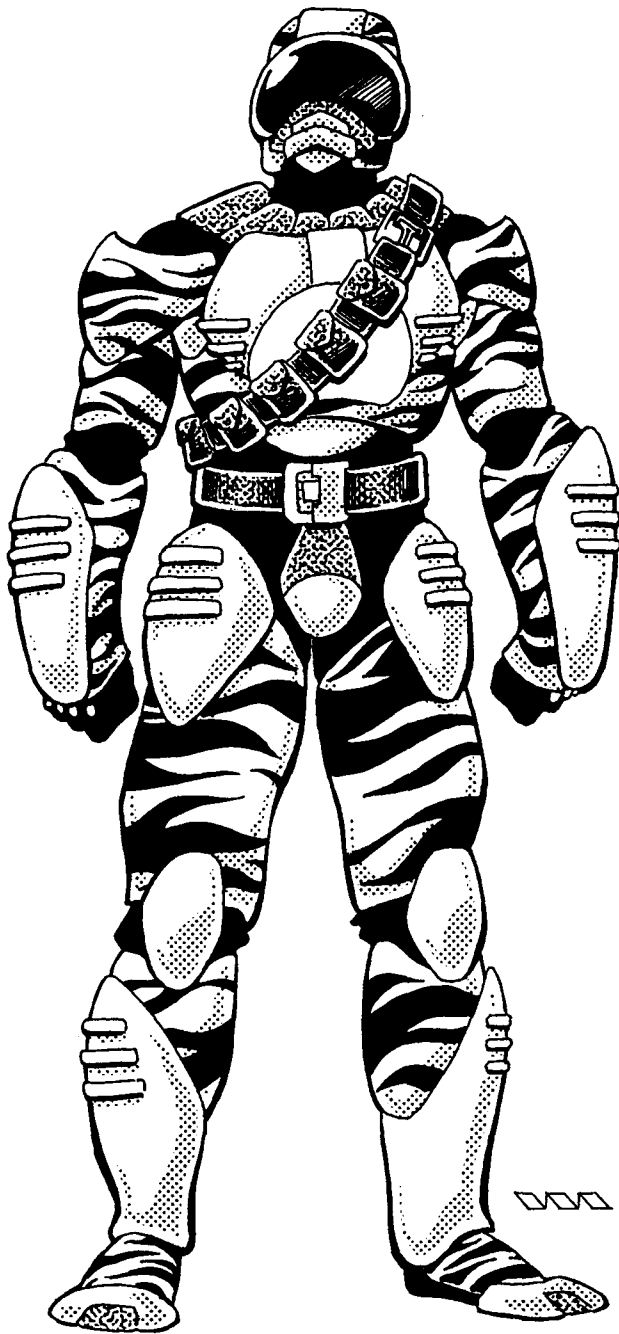

## AT-A14 Infantry "Trooper" Body Armor

### Standard for the Republic of Japan Armed Forces

Designed to be a universal armor, the "Trooper" suit has a high level of protection and good mobility. It is a combination of ceramic and metal plates and padding, with the Power Spy mesh used around joints and the waist for maximum flexibility and mobility. Plates and laminate cover the upper torso, arms, and most of the legs. Sections of the plating can be removed by technicians to allow characters with bionic weaponry to wear the suit while maintaining the environmental integrity and allowing access to (or exposure of) its special bionic limbs and/or weapons.

The AT-A14 is standard issue for the infantry of the Republican Army. Robot Power Armor (RPA) operators and robot pilots can also

wear this armor or the AT-A11 armor inside their robot vehicles. Police SWAT teams, special police operatives, EOD officers, and authorized security/guard agencies also use this armor.

- M.D.C.: 95
- Weight: 25 lbs (11.3 kg)
- Good mobility, -10% prowl penalty. Acrobatics, gymnastics, swimming and similar physical skills are performed at -15%.
- An electromagnetic pad is built into the back of the armor to which standard issue army rucksacks can be magnetically sealed. The pad is activated and deactivated by the wrist computer.
- A sound filtration and muffler system is built into the helmet to protect the wearer against explosions and rail gun fire, as well as the sonic boom of the Glitter Boy's Boom Gun.
- Thermo-imaging (2000ft/610 m), laser distancing (1000 ft/305 m) and a targeting sight (+1 to strike) are also standard features of the helmet.
- Colors: Black, white, woodland camouflage or tiger-striped. Officers are differentiated by a dark green rank insignia emblazoned on the armor and a different helmet styling.
- Market Cost: 38,000 credits; 48,000 credits on the black market; poor to fair availability.

## AT-A15 Marine Heavy Combat Body Armor Exclusive to the Republic of Japan Armed Forces

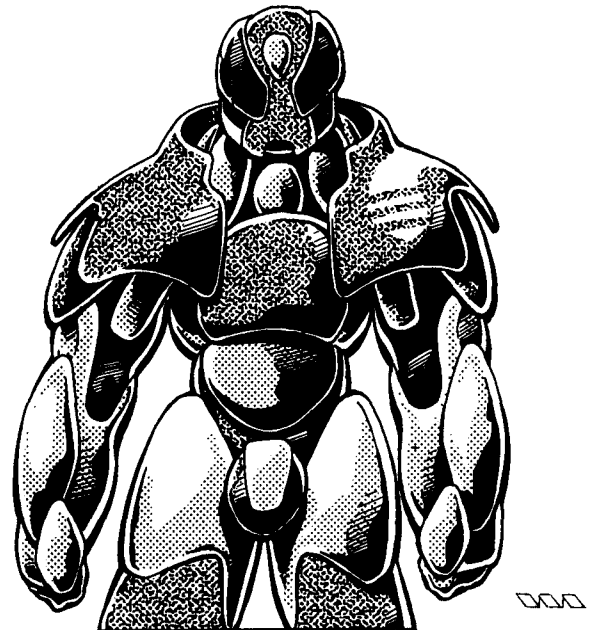

The Marine Combat armor is a full suit of heavy, plate armor that affords maximum protection, enhanced strength (exoskeleton), additional oxygen supply and all standard optics plus a HUD system. It is used in heavy combat situations by elite combat troops, Marines, and officers. It has also proven excellent for undersea combat, exploration and labor. The AT-A15 is exclusively used by the Republican Army.

- M.D.C.: 120
- Weight: 40 lbs (18 kg)
- Poor mobility, -35% prowl penalty.
- Exoskeleton adds 8 points to the wearer's natural P.S. attribute, +8 to spd, +10 feet (3.0 m) to leaps, and reduces the rate of fatigue by 50%.

- An electromagnetic pad is built into the back of the armor to which standard issue army rucksacks can be magnetically sealed. The pad is activated and deactivated by the wrist computer.
- A sound filtration and muffler system is built into the helmet to protect the wearer against explosions and rail gun fire, as well as the sonic boom of the Glitter Boy's Boom Gun.
- **Thermo-imaging** and telescopic sight (2000 ft/610 m), laser distancing, passive nightvision, infrared vision (all 1000 ft/305 m), and a targeting sight (+1 to strike) are also standard features of the helmet.
- Depth and pressure readouts are displayed on the **wrist computer** and HUD.
- Depth tolerance: 1000 feet (305 m) maximum.
- Colors: Black, white, woodland camouflage or tiger-striped. Officers are differentiated by a dark green rank insignia emblazoned on **the** armor and a different helmet styling. Armor for military underwater use is blue-grey; SEAL armor is black in color, with no insignia. Officer armor is navy blue with grey insignia.
- Black Market Cost: 85,000+ credits; rarely available.

## Ichto & H-Brand Armor

### IA-100 Infiltrator Body Armor

The Ichto corporation produces a light stealth armor it calls the "Infiltrator." It has been secretly adopted by some ninja clans in Japan and is also popular among spies, assassins and mercenaries. The armor consists of polycarbonate, metal plates, and padding.

The knuckles typically have claws overhanging the fingers (used for climbing and combat) or are covered with spikes. The left arm typically contains a spike or grappling hook launcher and cord for climbing. The right arm typically has a light laser or retractable **vibro-blade** (both do 2D4 M.D.; the laser has a 300 ft/91.5 m range). A video camera combined with a telescopic lens (8x magnification) and passive nightvision is mounted on the helmet over the right eye. As many as 16 hours of video (two 8 hour mini-disks) can be recorded. A transmitter/receiver backpack can be used to transmit or receive recordings.

- **M.D.C.:** 60
- Weight: 20 lbs (9.1 kg)
- Excellent mobility; -8% prowl penalty.
- Environmental with standard features; +5% to climb skill.
- Electro-adhesive pads on the hands and feet allow the wearer to climb metallic structures easily.
- Concealed wrist computer used to activate adhesive pads, show oxygen and damage levels, date, time and compass direction. It can also be used to interface with other computers and has a number of pre-loaded programs to aid in computer hacking, or cracking electronic locks (+5% bonus to each skill).
- Color: Dull black, dark green, dark red, or camouflage.
- Available only on the black market. Illegal in the Republic of Japan. Black Market Cost: 45,000 credits; fair availability.

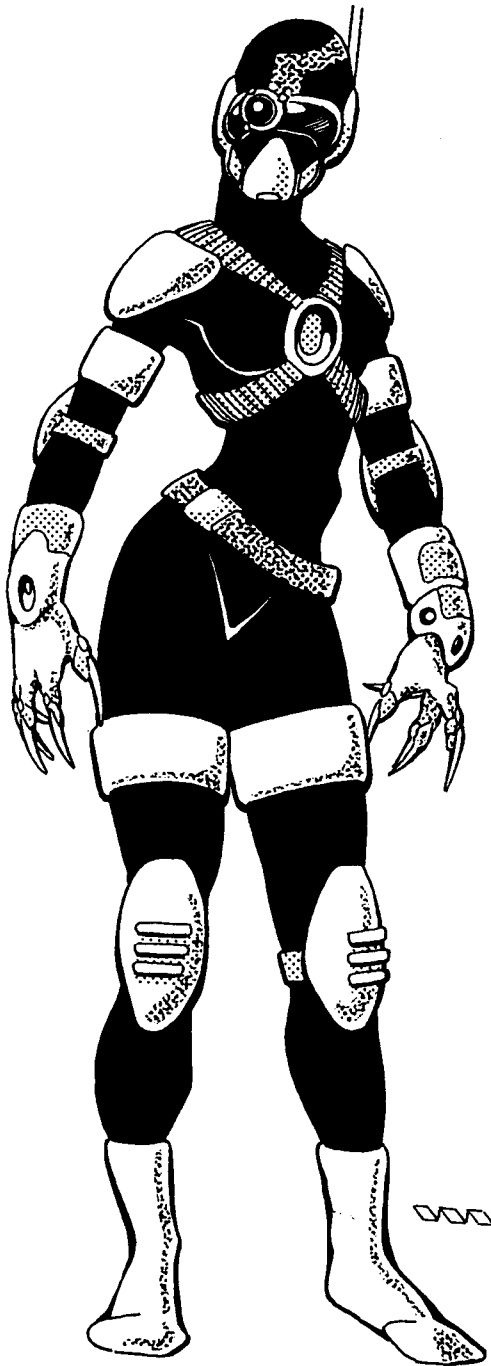

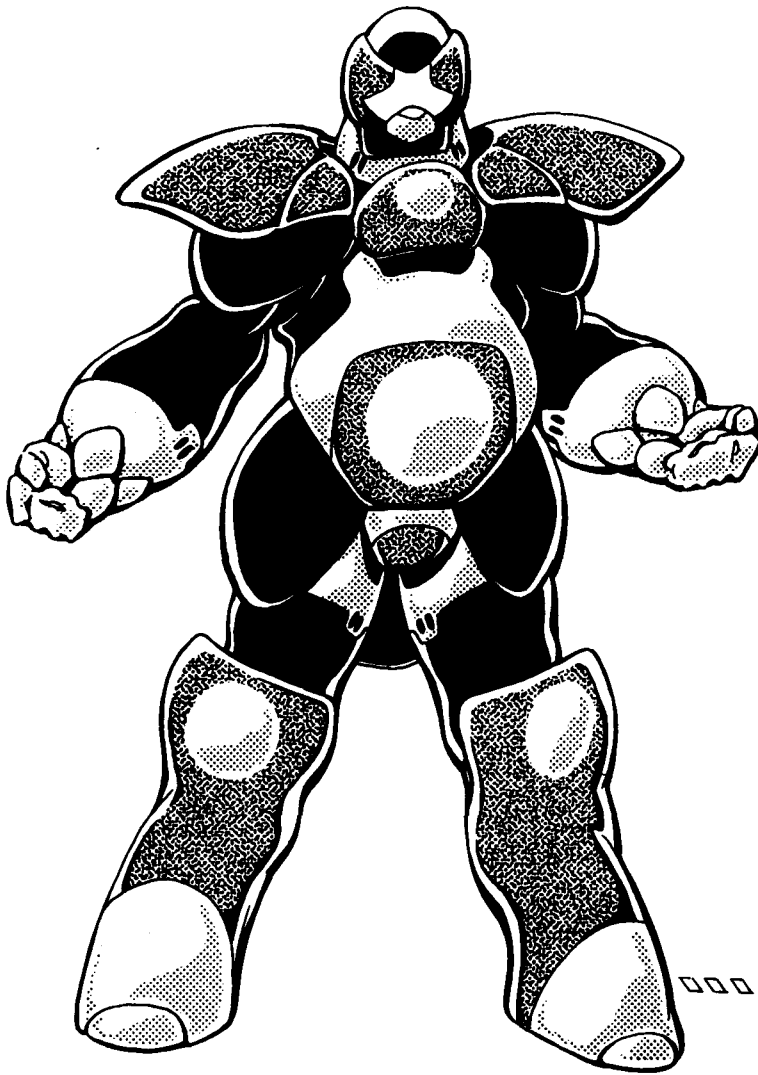

## IA-130 "Sumo" Body Armor

The Ichto corporation's "Sumo" armor gets its name from the fact that it is very bulky and has a pot-belly appearance. It is a heavily armored, full environmental suit augmented by a light exoskeleton to support its weight and make it reasonably **maneuverable**. The armor is generally considered a failed experiment and is popular only among adventurers and traveling merchants. Its bulk and poor mobility make it unappealing to most warriors.

- M.D.C.: 145
- Weight: 80 lbs (36 kg)
- Terrible mobility, -60% prowl penalty and reduce speed by 20%. Acrobatics, gymnastics, swimming and other physical skills are performed at -60%. Takes twice as long to suit up.
- Fully environmental with standard features.
- The exoskeleton adds +6 to P.S. and is +1 to roll with impact or fall.
- Market Cost: 40,000 credits; scarce availability. Illegal in the Republic of Japan.

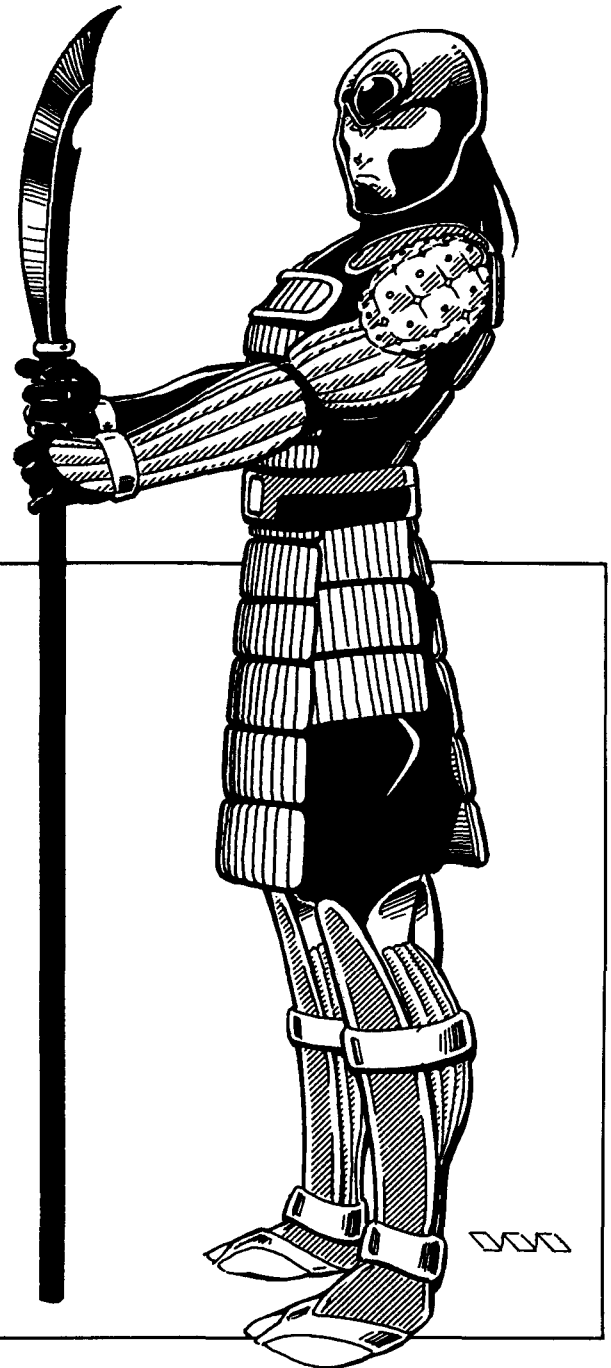

## HA-4 & 5 "Hiker" Body Armor

A light, non-environmental, **H-Brand** body armor of padded mega-damage plates, with a helmet and gas mask. It offers reasonable protection, good mobility and is comfortable to wear. It comes in a variety of body stylings, but most are simplistic. This armor is especially popular among farmers, travelling merchants, security guards, explorers and adventurers living, working or travelling outside the safety of the big cities.

- M.D.C.: 45
- Weight: 16 lbs (7.2 kg)
- Good mobility, -10% prowl penalty.
- Color: Produced in light and dark blue, tan, rust, gold, silver and grey.
- Market Cost: 18,000 credits, good availability. Legal in the Republic of Japan, provided the armor is registered with the police and a permit is issued.

**Note:** The HA-5 is fundamentally the same type of armor but is made to look like traditional splint laminate or bamboo samurai armor. All stats are the same except the armor weighs 22 pounds (10 kg) and costs 21,000 credits. It is extremely popular.

## HA-6 & 7

### "Frontiersman" Body Armor

A more heavily armored **H-Brand** suit that is a full *environmental armor*. Thousands of the suits have been sold to colonists in The Zone, adventurers and mercenaries. It is a bare bones armor with respectable mobility, good protection and fair price.

- **M.D.C.:** 70
- **Weight:** 24 lbs (10.9 kg)
- Fully environmental with standard features.
- Colors include woodland camouflage, olive green, tan, rust, black, white and grey.
- **Market Cost:** 27,000 credits, good availability. Sold by **H-Brand** and **Ichto**. Illegal in the Republic of Japan.

**Note:** The HA-7 is fundamentally the same type of armor but is made to look like traditional samurai armor. All stats are the same except the armor costs 30,000 credits.

## HA-20 Juicer Environmental Armor

This is a fully enclosed, environmental armor used by many of the Juicers of Japan. The armor vaguely resembles the armor in North America, but has a more Japanese/samurai flavor to its design. The helmet completely encloses the head and has a menacing, skull or demonic appearance. Many Juicer suits are covered in spikes.

- **M.D.C.:** 75
- **Weight:** 20 lbs (9.1 kg)
- Good mobility, -10% prowl penalty.
- All standard features plus the following:
- A sound filtration and muffler system is built into the helmet to protect the wearer against explosions and rail gun fire, as well as the sonic boom of the Glitter **Boy's** Boom Gun.
- **Thermo-imaging** and telescopic (2000 ft/610 m), laser distancing and a targeting sight (+1 to strike; 1000 ft/305m range), HUD system, and passive **nightvision** are standard features of the helmet.
- **Colors:** The armor is often multi-colored but the colors are usually suitable for night maneuvers and combat. Black and silver/grey, **black/grey** and red, and gold and black are among the most popular combinations, but greens, blues and other colors are available.
- **Market Cost:** 38,000 credits on the black market; fair to good availability. Illegal in the Republic of Japan.

**Note:** Ichto also makes a similar suit of armor for Juicers.

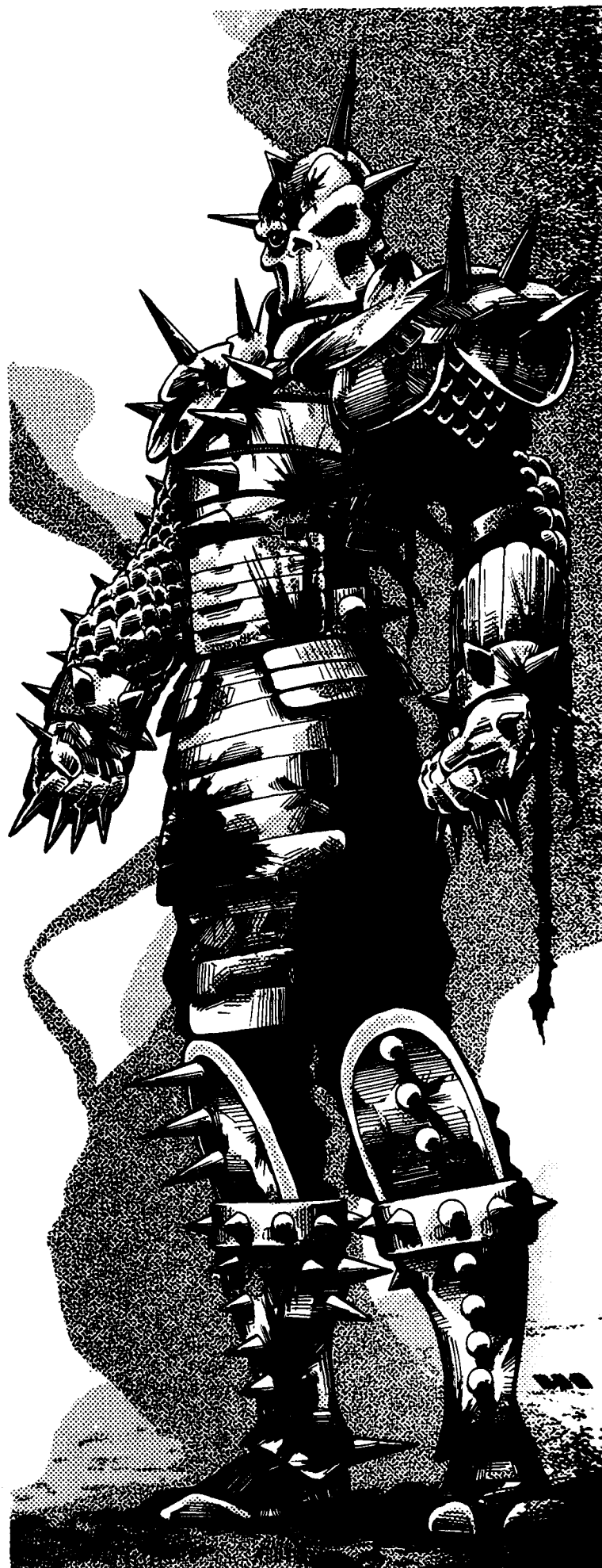

---

# Japanese Skills of Note

---

## Alphabetical List of New Skills by Category

### Communications:

Electronic Countermeasures

### Domestic:

Bonsai

Calligraphy

Floral Arrangement

Gardening

Go

Poetry (Haiku)

### Espionage:

Imitate Voices/Impersonation

### Mechanical:

Basic Mechanics

### Military:

Armorer

Camouflage

Nuclear, Biological, & Chemical Warfare

Parachuting

### Physical:

Hand to Hand: Aikido

Hand to Hand: Basic Martial Arts/Judo

Hand to Hand: Karate

Hand to Hand: Kendo

Hand to Hand: Jujitsu

Hand to Hand: Ninjitsu (see Ninja O.C.C.)

Hand to Hand: Teng-jutsu (see Tengu R.C.C.)

Hand to Hand: **Zanji Shinjinken-Ryo** (see True Samurai O.C.C.)

Pilot:

Horsemanship: Exotic Animals

### Pilot Related:

Radar/Sonar Operations (Read Sensor Equipment)

### Rogue:

Find Contraband, Weapons & Cybernetics:

### Technical:

Japanese Mythology

Lore — Magic

### Weapon Proficiencies:

W.P. Bow

W.P. Cross Bow

W.P. Forked/Trident

W.P. Grenade Launcher

W.P. Mouth Weapons (blow guns)

W.P. Slingshot

W.P. Small Thrown Weapons

W.P. Spear

W.P. Staff

W.P. Whip

**Communications: Electronic Countermeasures (Jamming):** Useful for preventing the enemy's communications from working. Since all armor, power armor and robot vehicles are linked by radio transmissions, jamming can cause unit confusion and disrupt communications. Military organization breaks down, causing a loss of effectiveness for all but the best of units.

Just about any high-powered radio can be used for jamming. Armed with a radio, a small guerrilla unit can completely disrupt the maneuvers of large enemy groups. This skill also enables the radio operator to "follow" the enemy's attempted transmissions over jammed frequencies to trace their general location, a specific building, or direction. This tactic is extremely useful in finding and eliminating lone power-armor troopers. **Base Skill:** 30% +5% per level of experience. Note: If the G.M. likes, he can make this part of the *Radio: Scrambler* skill, but still with a base of 30%.

**Domestic: Bonsai:** Tending, trimming and growing tiny miniature trees known as the "Bonsai." Experts can tell the difference between new (under 50 years old) and truly ancient bonsai (hundreds of years old). The character can also estimate the value and quality of the miniature tree. Bonsai is a common pastime of the noble castes in the New Empire. **Base Skill:** 50% +4% per level of experience.

**Domestic: Calligraphy:** The ability to produce beautiful Japanese letters using a brush, ink and paper with great skill and legibility. He can also copy Chinese characters/symbols and, if the character has taken the Chinese language and literacy skills, he can write Chinese.

Traditionally, any person of culture and education, especially a noble, is expected to be able to produce gorgeous ideograms. Calligraphy is a skill almost as necessary as literacy for traditionalists.

**Base Skill:** 35% +5% per level of experience.

**Domestic: Floral Arrangement (Ikebana):** The artful and creative arrangement of flowers appreciated by everyone throughout the orient. A painstakingly difficult art that takes years to really master. The creation of a good floral arrangement is a matter of honor to those who practice Ikebana; a bad job will be scorned even if done by the most heroic of warriors. This "art" is appreciated in modern and traditional Japan. **Base Skill:** 30% +3% per level of experience.

**Domestic: Gardening:** This skill offers a basic understanding of plant care and garden design. It can be both the ability to grow enough food to eat well, and/or the skill at creating beautiful, decorative gardens (with plants and rocks) that create a feeling of tranquility and harmony with nature; Zen gardening. This "art" is appreciated in modern and traditional Japan. **Base Skill:** 34% +4% per level of experience.

**Domestic: Go:** As chess is the most widely accepted intellectual game of the west, so Go is accepted as the most "enlightening" game of the eastern world. In many cases one's skill at Go is seen as much more important than ability in the fighting arts. A victory at the intelligent game of Go easily outweighs any ten wins in single combat. **Base Skill:** 30% +5% per level of experience.

**Domestic: Poetry (Haiku):** Creating good, and sometimes inspirational, poetry, "Haiku" are short, three line, seventeen syllable poems that are the national poetry of Japan. Poetry often accompanies important events in society. For example, a samurai compelled to commit ritual suicide is expected to compose a "death poem." **Base Skill:** 35% +5% per level of experience.



**Espionage/Ninja: Imitate Voices & Impersonation:** The ability to imitate the voice, accent and expressions of another person or area. This skill is common among ninja, spies, and priests as well as tengu and oni. The first number indicates the character's ability to change his voice and imitate accents, inflections and expressions from other regions. A successful roll means he has disguised his normal/true speaking voice and accent, and convincingly sounds like he is from another region or part of the world.

The second number indicates the character's ability to accurately imitate the voice, inflections and attitude of a *specific person!* This is much more difficult, and the character will either need to know the person being imitated very well or have spent hours studying him/her. **Base Skill:** 36%/16% +4% per level of experience.

**Note:** When combined with the disguise and intelligence skills, the character is able to completely impersonate another person or type of occupation (soldier, ninja, priest, etc.). This is likely to include a knowledge of the enemy/subject of impersonation, military procedure, dress, command, rank, and will usually require speaking the language fluently. This means the character can convincingly impersonate a general type of person/soldier/advisor with accurate disguise, proper action, and language. **Base Skill:** 16% +4% per level of experience; +12% to impersonate general personnel and occupations.

**Mechanical: Basic Mechanics:** A general familiarity and understanding of basic mechanics. This character can fix a toaster, repair a bicycle, replace a belt on a motor, repair or replace a switch, handle or a knob, replace a spark plug, change oil, assist in automobile repairs, maintain machinery, read a schematic and similar fundamental tasks. **Base Skill:** 30% +5% per level of experience.

**Military: Armorer:** This is a somewhat simplistic version of the weapons engineer as it applies to infantry weapons. A competent armorer character can maintain, fix, modify, mount, **reload/charge** ammunition, and figure out most small arms. They can repair all types of pistols and rifles, adjust targeting sights, use optical enhancements, reload missiles and ammo drums, recharge **E-clips**, install/mount a rail gun or machinegun on a vehicle, and even fix most small robot and bionic weapons like forearm blasters and retractable blades. **Base Skill:** 40% +5% per level of experience.

**Military: Camouflage:** The skill of concealing a fixed base position, vehicle, **bot**, equipment or individual, using natural or artificial materials. A fair amount of time is involved in the preparation of a larger position. Large cargo nets, cut branches or underbrush are used most often in camouflage. This skill is also used to conceal traps. **Base Skill:** 20% +5% per level of experience.

**Military: Nuclear, Biological, & Chemical Warfare (NBC):** This is the knowledge of safety precautions to protect oneself and others from the effects of nuclear, biological or chemical warfare, waste and contamination. The character is also knowledgeable in the safe handling and "clean-up" and containment of such hazardous materials. **Base Skill:** 35% +5% per level of experience.

**Military: Parachuting:** The skill of parachuting includes the methods, procedures, and techniques of parachuting, packing the chute, sky-diving techniques, precision landing, landing without **injury**, and practice of jumping from a high **altitude** aircraft. The advantage of parachuting is secrecy, since the troopers' insertion into enemy territory is silent and often goes unnoticed. The following three methods are the ones most commonly used by modern paratroopers:

**High-Altitude-High-Opening (HAHO)** jumps take place from a height of 25,000 to 30,000 ft. As the paratroopers drop they travel laterally to the desired drop zone (DZ) where they wish to land. This

technique is used to "throw off enemy units since they will probably search for paratroopers directly beneath the path of the aircraft.

**High-Altitude-Low-Opening (HALO)** operations also begin at 25,000 to 30,000 ft (7620 to 9144 m) but the paratrooper does not pop the chute until an altitude of 4,000 ft (1220 m), or even less. The jump takes place so rapidly that there is little chance for the paratroopers to be viewed after the chutes open.

**The most dangerous method is Low-Altitude-Low-Opening (LALO) drops.** The jump is made at the mere height of 300 to 500 ft (91.4 to 152 m). If there are any complications (a failed roll) the paratrooper is likely to be injured (broken bones) or killed (30% **chance**)! Even if the jump goes without a hitch, there is a 20% chance of taking 6D6 S.D.C. from an awkward landing, even if wearing M.D. armor.

Failure on a parachuting roll indicates that there are complications somewhere along the jump. This might mean an improperly packed chute, tangling of lines, etc. On a high altitude jump, the character gets a second roll for their reserve chute. If the second roll also fails then the character falls to his death! There is not enough time on a low altitude drop to use a reserve chute, so a failed roll means the character hits the ground (humans die!) without a second chance. Parachuting can be selected as a Military or Pilot Related skill. **Base Skill:** 40% +5% per level of experience.

**Pilot: Horsemanship: Exotic Animals:** This skill is basically the same as the original horsemanship skill, except that the character is experienced in riding other types of "tame" animals. This can include elephants, camels, lamas, pegasus, dragonductyls, gryphons, demon hounds, fury beetles, giant insects, Wormwood parasites, and other alien or monstrous beasts trained to be riding animals. Wild, untamed creatures cannot be ridden (except by the likes of the Simvan monster riders). **Base Skill:** 30%+4% per level of experience.

**Note:** Characters with the traditional "horsemanship" skill for riding Earth horses and other very horse-like animals can quickly figure out how to ride exotic and alien riding animals, but at a skill penalty of -12% to ride ground/running animals and -14% to ride flying or tree climbing and leaping animals. Similarly, D-bees not familiar with riding the fast and sleek Earth horse are -10% to ride them.

**Pilot Related: Radar/Sonar Operations (Read Sensor Equipment):** The ability to use radar (radio echo bounces) and sonar (underwater sound echo bounces) equipment and correctly read the information to precisely locate and follow aircraft, ships and submarines. This is all included in the skill ability to *read sensor equipment*. **Base Skill:** 30% +5% per level of experience.

A note about sonar: In submarines there are two methods or types of sonar operations, passive and active. To use active sonar, the sub must give a pulse of sound to bounce off any nearby ships or objects. This is very dangerous since it immediately gives away the position of the ship; most subs will not use active sonar unless absolutely necessary.

Most submersibles will rely on *passive sonar* systems. This is much more difficult since the sonar operator must sift through the background noise to find any enemy ships. Sometimes they will not be able to distinguish the location of a ship from the background static. Despite this fact passive sonar is used because it does not give away the location of the sub. **Skill Penalty:** -15% on read sensory equipment skill.

**Rogue: Find Contraband, Weapons & Cybernetics:** The character with this skill knows where to find arms dealers, smugglers, body chop-shops, M.O.M. and Juicer conversions, criminal cyber-docs

and illegal medical treatment, as well as how to spot them. He is also familiar with their practices, **hang-outs**, gang or criminal ties, general practices, code of conduct, pricing structures and modes of operation. Likewise, the character has a good idea of what black market weapons and cybernetics should cost and what these people pay for contraband items (typically about 20% of what they sell it for). The character also knows the penalty for being caught with an illegal weapon, implant or bionics. For most societies, any M.D. weapons, concealed weapons and **sidearms** are forbidden inside large population centers.

This skill is especially appropriate in the modern cities of Rifts Japan, as well as in large cities of the Coalition States, the NGR, Atlantis, and other large, modern cities. **Base Skill:** 26% 44% per level of experience. Note: This skill *should* be considered a separate skill apart from streetwise.

**Technical: Japanese Mythology:** Includes extensive knowledge of the vast library of works on Japanese myths relating to ghosts, spirits, **demons/oni**, goblins, faerie folk, monsters, dragons, immortals, undead, elemental forces, supernatural animals and gods. Japanese mythology has so many gods and supernatural beings, including Buddhist and Shinto, that the phenomenon had been called by some 20th Century scholars, the "rush hour of the gods." **Base Skill:** 30%+5% per level of experience. This skill also gives the character a fair understanding of Chinese Buddhist gods and demons (-10% skill penalty) and even Hindu and Brahmin gods (-20% skill penalty).

**Technical: Lore — Magic:** This area of study does not give the character any magic powers or the ability to read magic symbols. What it provides is general information about magic, magic creatures and

myths about magic. For example, a character with this skill knows about the general powers and abilities of infamous magic creatures such as the various types of dragons, sphinxes, unicorn, and so on. He'd know what the main types of magic (on Earth or at least his geographic area) are, such as spell casting, summoning, rifting, **techno-wizardry**, stone magic, temporal magic, bio-wizardry, rune magic, necromancy, and so on. Likewise, the character is likely to know about powerful magic items, magic places, magic curses and legends. Although the character cannot read runes or mystic symbols, he is should be able to recognize whether the symbol is a real magic ward, rune or warning. The following abilities come with this layman's skill: **Base Skill (general knowledge):** 25% +5% per level of experience. **Recognize magic wards, runes and circles:** 15% +5% per level of experience. **Recognize enchantment:** i.e. magic items, people under charms and curses, etc.; 10% +5% per level of experience.

## Weapon Proficiencies:

**Ancient Weapon Proficiency: W.P. Forked/Trident:** Includes sai, tiger forks, tridents, and other weapons with tines. **Bonuses:** Start with +1 to Strike and +2 to Entangle at level one. +1 to Strike at 3rd, 5th, 7th, 9th, 12th and 15th levels. +1 to Parry at 5th, 9th, and 13th levels. +1 to Entangle at 2nd, 5th, 8th, 10th, 12th and 14th levels.

**Ancient Weapon Proficiency: W.P. Spear:** Combat skill with large and small spears. The use of a rifle equipped with a bayonet also falls into this category. **Bonuses:** +1 to strike and parry at levels 1, 4, 7, 10, and 13. +1 strike when thrown at levels 2, 4, 8, 12, and 15.

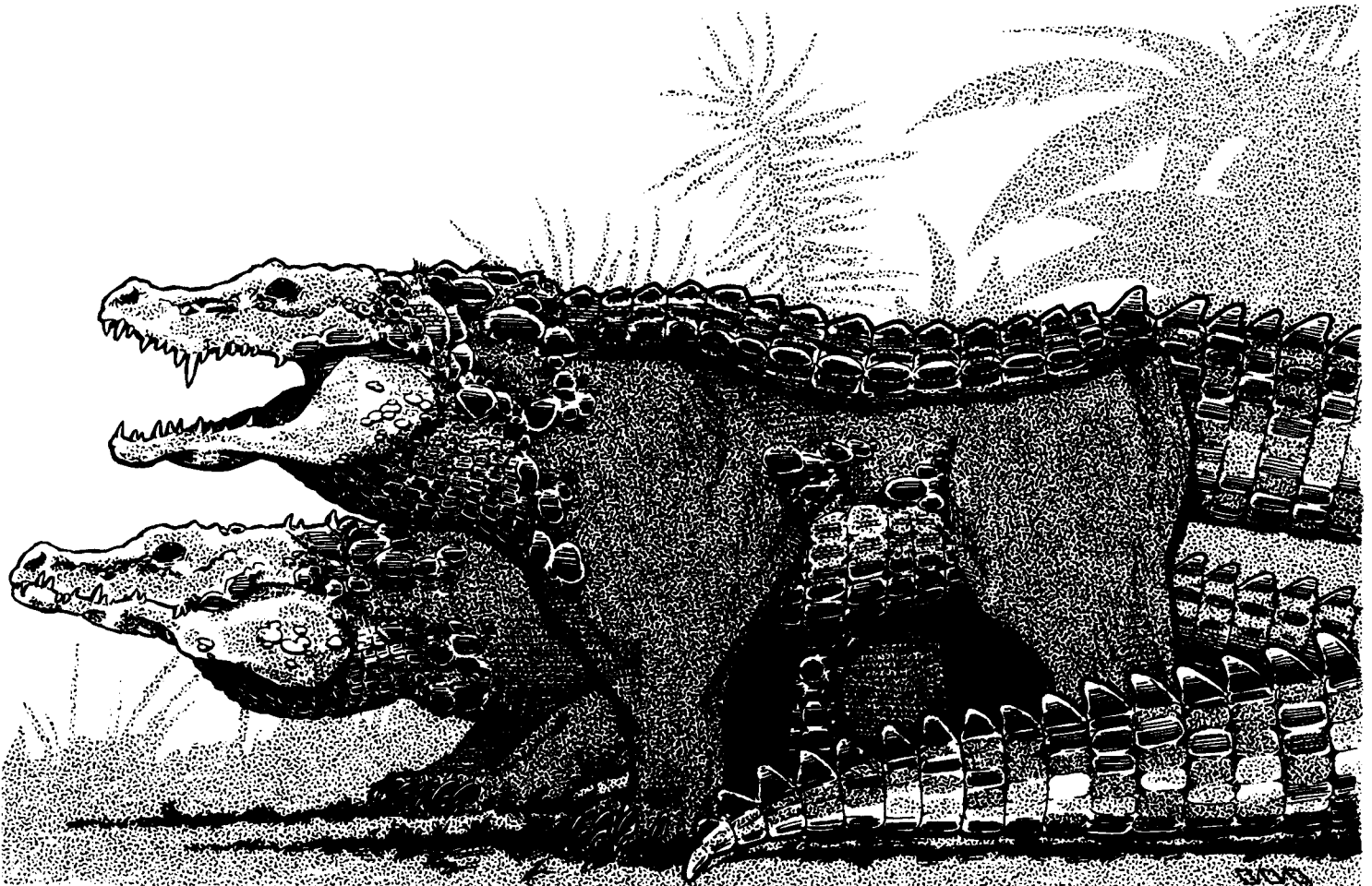

**Ancient Weapon Proficiency: W.P. Staff:** Combat skill with large and small staves. **Bonuses:** +1 to strike at levels 1, 3, 7, 10 and 13. +1 to parry at 2, 5, 8, 11 and 14. +1 to strike when thrown levels 4, 8, and 14.

**Ancient Weapon Proficiency: W.P. Whip (New!):** Skill at "whipping" or snapping with long, flexible, light weapons. **Bonuses:** Start with +1 to Strike at level one. +1 to strike at 3rd, 5th, 7th, 9th, 11th and 13th levels. +1 to damage at 4th, 8th, and 12th. +1 to entangle at 2nd, 6th, 8th, 10th, and 14th levels.

## Projectile Weapons (not guns)

Includes Bows, Crossbows, Slingshots and small thrown Weapons. The number of shots per melee is totally independent of the character's attacks per melee round.

**W.P. Mouth Weapons (Ninja!):** Includes blowpipes, mouth darts, and other weapons that depend on a person's lungs and aim out of the mouth. **Bonuses:** Start with +1 to strike at 1st level. Add +1 to strike at 4th, 8th and 12th levels. An extra shot per melee round is added at 3rd, 7th and 11th levels.

**W.P. Small Thrown Weapons:** Includes shuriken, throwing spikes, etc. **Bonuses:** Start with being able to throw three per melee round. +1 to throw at 4th, 7th, 10th and 13th levels. Extra shot per melee at 2nd, 3rd, 5th, 6th, 8th, 9th, 11th, 12th, 14th and 15th levels.

**W.P. Bow:** Includes short bow, long bow, Samurai bow, Mongol bow, and Ninja short bow, as well as modern compound bows. **Bonuses:** Start with +1 to strike and two shots per melee round. Add +1 to strike at 2nd, 4th, 7th, 10th, 13th and 15th levels. An extra shot per melee round is added at 2nd, 4th, 5th, 8th, 10th, 12th and 14th levels.

**W.P. Crossbow:** Includes both heavy and light crossbows. **Bonuses:** 1 shot per melee at first level. +1 to strike at 2nd, 4th, 6th, 8th, 10th, 12th and 14th levels. An extra shot per melee round is added at 2nd, 5th, 7th, 9th, 11th, 13th and 15th levels.

**W.P. Slingshot:** Includes both ancient slings and modern slingshots. **Bonuses:** +1 to strike and 2 shots per melee at first level. +1 to strike and an extra shot per melee at 2nd, 4th, 6th, 8th, 10th, 12th and 15th levels.

**Modern Weapon Proficiencies: W.P. Grenade Launcher:** Any device, including certain rifle models, that fire grenades. This skill includes the use of the Triax pump-weapons (i.e. TX-16) and the launcher of the CS-14 "Firebreather." +1 to strike at levels 3, 7 and 11.

culture and history. However, a number of oriental martial arts have survived in China and Japan. Both the modern warriors of the Republic and the traditionalists of the New Empire know and practice the martial arts, particularly the latter. Furthermore, some of the gods and supernatural creatures like the tengu, know and occasionally teach some of the old fighting arts to a new generation.

Typically, martial arts are studied from an early age and practiced for years. Hence, most martial arts offer the character some physical bonuses in addition to fighting skill.



---

# Hand to Hand Combat

---

Most Japanese martial arts are based on fighting styles that have evolved and been known for a thousand years. Most are much more advanced than the fundamental forms of hand to hand fighting skills presented in the **Rifts RPG**. Many of these fighting techniques and styles were created because under the rule of the ancient military dictatorships of the Shogun, only the samurai (and some fighting monks) were allowed to carry weapons. To counter this, several styles of "hand to hand" combat were developed. This is why *ninjitsu* was created by the ninja clans, along with the ninja's small, easy to conceal weapons like throwing stars and spikes, short sword and nunchuku. Other fighting styles grew out of the use of a particular weapon, like the *zanji shin-jinken-ryo* martial arts of the samurai.

Most forms of the **pre-Rifts** martial arts known throughout the world were lost because of the Great Cataclysm, along with much of human

## Martial Arts Combat Terms & Moves

**Note:** The following combat maneuvers are applicable to many martial arts, in addition to the basic moves listed in the combat section of the **Rifts RPG**. A specific martial arts skill will indicate which of these moves are available.

**Automatic Body Flip/Throw:** Certain martial artists can do a body flip/throw *in place of a parry*. This means, that instead of blocking or deflecting the blow, the character attempts to leverage the attacker's own force into a flip. Success requires beating the attacker's roll to strike, just like a parry, but using the bonuses for body flip (not parry). Failure means taking full damage from the attack, without a chance to roll with **punch/fall/impact**. A successful roll means the character has grabbed his opponent and sent him flying in a judo-style throw.

**Automatic Dodge:** Certain martial art forms enable the character to automatically *dodge* an attack without using up a melee **attack/action**, just like a parry. It is purely a defensive move. Roll for a dodge as normal, just don't add the movement penalty of losing a melee action.

**Back flip: Defense:** The back flip involves throwing oneself backwards with the arms and shoulders, flipping the legs completely up, over, and back down on the ground into a standing position. The result is that one quickly moves backwards by a full body. Doing a back flip counts as one melee **attack/action**.

If used in place of a dodge, the character must roll over the opponent's strike roll using only the bonus to back flip. Failure to beat the strike means taking full damage *without a chance to Roll with Punch*. Success means avoiding the attack like a dodge.

**Back flip: Escape.** If used in place of a strike (when it's the back-flipping character's turn to strike) this removes the character from combat and requires the opponent to use up an **attack/action** to move into range. This also gives the back flipping character the initiative.

**Back flip: Attack.** This is especially useful against someone attempting some kind of back strike. Once the opponent is detected in the rear, the back flip moves back into combat range. A back flip can also be used as a combined Strike against an opponent to the rear of the character. Use with either an axe kick, snap kick, or backhand strike. If striking with a back flip use only the bonus to back flip (not strike). Cannot be used with death blow or **knock-out/stun**.

**Body Block/Tackle:** This is a combination of a damage causing body block and a knockdown attack. A successful attack does **1D4** damage (P.S. damage bonuses apply) and the opponent is knocked down. The victim can do only one of the following two defensive moves: a dodge or maintain balance. A successful dodge means no damage and no knockdown, but failure means damage, knockdown and the loss of one attack that melee round.

A successful maintain balance means the victim is not knocked down but loses an attack and takes full damage.

**Body Flip/Throw:** A judo style throw or flip that uses an attacker's own momentum and leverage to "flip" or "throw" him off his feet and onto the ground. Damage is **1D6** points but the victim also loses initiative (if he had it) and one melee attack. The P.S. damage bonus should be added to the damage inflicted. A victim of a throw can try to *roll with impact/fall* to diminish the damage (half if successful), but other penalties are unchanged.

**Body Flip/Throw: Critical:** Characters with this attack inflict double damage; typically **2D6** + P.S. bonuses by rolling a certain "natural" die roll (a high number not modified with bonuses). The victim of a critical body throw loses initiative and *two* melee actions/attacks as a result of being thrown. This move cannot be done with an automatic body flip/throw because it is an attack, while the latter is a defensive move.

**Break fall:** Also known as "**ukemi**," this is an advanced version of roll with **punch/fall/impact**. The character takes **no** damage if the break fall is successful, and only half damage if the roll for break fall fails! It can also be used against a knock-out attack. A successful roll against knock-out means the character takes normal damage, but is not stunned or unconscious. Note: The break fall uses up one melee attack each time it is used.

**Cartwheel (Attack):** Holding the body rigidly extended, the character rolls like a wheel by using the arms and legs as spokes. This maneuver can be used to move quickly into combat range. A cartwheel can also be used as part of a combined strike against an opponent to the rear of the character when used with either an Axe kick, Wheel kick

or Knife Hand. If striking with a cartwheel, use only the cartwheel bonus. Must be used as the first attack in a melee round. Note: Cannot be used with death blow or **knock-out/stun**.

**Critical Strike:** A powerful, special or nerve shattering strike that inflicts double the usual damage.

**Death Blow (revised):** A special attack designed to kill an opponent in one or two strikes! This attack is often limited in hand to hand combat to the roll of a "natural" high strike number; i.e. death blow on a natural **18-20**. Whenever the words "death blow" are presented without limitation, the character can use a death strike whenever he desires; however, such a devastating attack counts as two melee attacks/actions.

**Human vs Human:** Against humans and S.D.C. creatures, the attack does double the normal damage, plus P.S. bonuses direct to hit points. This attack can be used with punches and kicks or hand held weapons such as swords, clubs, etc. It is not applicable to guns and does not work through armor; the armor must be removed or penetrated.

**Mega-damage creature vs Mega-damage creature:** The attack does double normal damage, plus P.S. bonuses, and it is so devastating to the creature's body that it cannot *bio-regenerate* injury from a death blow for **1D4** hours! This attack is not applicable against M.D.C. bots, **borgs** and power armor, unless the M.D.C. attacker is making a called shot to the head or power supply, in which case double damage is inflicted to that part of the robot or armor.

**Note:** The yamabushi, monk, demon queller and samurai can use a *chi death blow* attack against oni/demons and other mega-damage beings with the same effect as above! See the *True Samurai O.C.C.* for details.

**Drop Kick:** This is the combination of falling to the ground, a dodge and a kick. The kick can be either a kick attack, a snap kick or a crescent kick. It's done in place of a dodge (or as an attack) as a defensive move. First, make the roll to Dodge. If successful, then roll to Kick. The opponent can defend normally. No bonuses to dodge, strike, kick or damage apply for this move. Uses up one melee **attack/action**.

**Damage:** The following are some of the typical damage amounts inflicted by the various types of punches and kicks. Each inflicts roughly the same equivalent S.D.C. or M.D. damage depending on whether the attacker is an S.D.C. being (like humans) or a mega-damage being (like power armor, bots, oni, dragons and supernatural beings). Remember to add P.S. attribute bonuses to damage.

Hand Strikes:

Backhand Strike — **1D6**

Body Flip — **1D6**

Human Fist (punch) — **1D4**

Knife Hand — **2D4**

Karate Strike — **2D4**

Palm Strike — **2D4**

Elbow/Forearm — **1D6**

Power Punch — does double damage, but counts as two melee attacks. Applicable to all hand strikes.

Foot Strikes:

Kick Attack - **2D4**

Karate Kick Attack — **2D6**

Jump Kick — **3D6x2**

Roundhouse Kick — **3D6**

Snap Kick - **1D6**

Wheel Kick — **2D6**

Knee - **1D6**

**Backward Sweep** - No damage, but knocks down opponent if strike is successful (he loses one melee action and initiative).

**Tripping/Leg Hook** - No damage, but knocks down opponent if the strike is successful (he loses one melee action and initiative).

**Power Kick** — Does double damage, but counts as two melee attacks. Applicable to all kick/foot strikes that inflict damage, except leap and jump kicks.



**Disarm:** The act of disarming is simply getting rid of the opponent's weapon; it does no damage. It can be used as a defensive move in place of a dodge or parry, or can be done as an attack/strike.

The disarm move is a strike, hold or grappling maneuver that causes an opponent to drop his weapon or whatever he's holding. Counts as one melee **attack/action**. Disarm does not give the weapon to the character making the disarm move. True, the item is forced out of the victim's grasp, but it is either knocked away or falls to the ground.

Typically an opponent is disarmed on a roll of a natural 19 or 20 when used as a defensive move. Roll a disarming strike to attack as usual — high roll wins. A failed disarming attack does no damage and means one's opponent remains armed, is probably mad, and ready to strike.

**Hold (optional):** Using both hands, the attacker grabs on to some part of the opponent's body and attempts to immobilize him. If the strike is successful, then the victim is helpless until released. Holds do no damage. Neither the attacker nor the victim can attack, parry or dodge while the hold is working. It's easy for the attacker to hold the victim so that some third character can attack unopposed or attack from the rear.

Getting out of a hold requires agility. Both the victim and attacker roll twenty-sided dice and add in their P.P. attribute scores. The person doing the hold also gets to add in all his bonuses to hold and from the P.P. attribute (if any). High roll wins! If the attacker wins, then the hold continues. If the victim wins, then the hold is released and combat can continue.

**Types of Holds Include:**

Arm Hold	Body Hold
Leg Hold	Neck Hold

**Arm Hold:** This involves twisting the arm around to the victim's back. Any items in the hand of the arm being held can be easily removed.

**Leg Hold:** The victim is on the ground with his leg held up. There's no way for him to get up until the hold is released.

**Body Hold:** Any number of wrestling holds. The victim can be held on the ground or in a standing position.

**Neck Hold:** The victim is held around the neck from behind. This leaves the victim totally vulnerable to attacks from any other character.

**Kick Attack & Flying Jump Kicks:** There are a whole range of foot-based attacks. Each kick attack works differently and does different amounts of damage.

**Kick Attack:** This is a conventional, karate-style, kick. It starts with bringing the knee, folded, up to chest level, then the foot is completely extended. Does 2D4 damage.

**Snap Kick:** A very short, very fast kick. Usually delivered low, striking the opponent somewhere below the waist. It works well in confined spaces and in grappling range but does relatively little damage; only 1D6 damage.

**Roundhouse Kick:** By turning the body and swiveling the hips, there's tremendous power packed into this kick. Can be used only once per melee round, and no other kicks can be used in that melee round. Does 3D6 damage.

**Wheel Kick:** A damaging kick that involves sweeping the leg completely around the body. Cannot come right before or right after another kick. Does 2D6 damage.

**Crescent Kick:** A swivel-hipped kick that sends the foot out on a sweeping arc. Does 2D4+2 damage.

**Axe Kick:** A very high kick that goes up and over the opponent, coming down on the neck or shoulder. Can't be used in the same melee round with any other kicks. Does 2D6 damage.

**Backward Sweep:** Used only against opponents coming up behind the character. Does no damage, it's purely a knock-down attack. Cannot be parried.

**Tripping/Leg Hook:** An attack on the opponent's legs. Does no damage, it's purely a knock-down attack. Cannot be parried.

**Jump Kicks** are performed by leaping completely off the ground and attempting to land foot-first on an opponent. Jump kicks can be used only by those skilled in hand to hand martial arts. The advantage of a jump kick is that it works as a critical strike and doubles the normal damage inflicted. The disadvantage of a jump kick is that no other attack may be performed in that melee round (all attacks for that melee are used up in the kick). The jump kick must be the character's first attack of that melee round. For the rest of the melee round, the character can only parry, dodge or move into position.

**Jump Kick:** Critical strike inflicting 6D6 damage!

**Flying Jump Kick:** Must be made from long range. The character launches into the air, taking a position that will smash one foot into the opponent. Does 4D6 damage but counts as two melee attacks.

**Flying Reverse Turning Kick:** Must be made from long range. The extra twisting and turning of the body adds power and does 4D6 damage but counts as two melee attacks.

**Leap Attack:** An airborne assault where the weapon and/or fists or feet are wielded in mid-leap. An attack must be made only at the beginning of a melee round and, like a jump kick, uses up *all* attacks for that melee round. Usually only a single strike can be made during a leap attack. However, if two opponents are close together, the attacker can leap between them and strike both at the same time; roll to strike for each character. After the leap, the character may not at-

tack again until the next melee round, but can parry or dodge or move into position. Note: Automatic parries work in mid-leaps but dodges are impossible.

**Maintain Balance:** When some kind of knockdown attack has succeeded, while the character is starting to fall over, this is his last chance attempt to recover. A successful roll (over the opponent's strike roll) means that the character will immediately regain his balance and remain standing. He can continue to fight but the act of retaining balance means he used up one melee **attack/action**. When maintain balance is used, then roll with **punch/fall/impact** or break fall can't be used.

**Paired Weapons:** Certain kinds of weapons, such as sais, **nunchaku**, daisho, knives, clubs and swords, can be used as paired weapons. Users of paired weapons can strike and parry simultaneously, can do twin strikes against a single target or against a pair of targets, and can parry two, different opponents at the same time. In other words, warriors skilled in paired weapons often can do two actions for every one of their melee attacks (i.e. strike and parry). However, a twin, simultaneous strike with both weapons means losing the automatic parry and leaves the character open to his opponent's next attack without benefit of a parry (dodge is optional but uses up a melee action).

**Pull Punch:** The ability to control the force of a hand to hand attack, whether it be a punch, kick or with a hand weapon. The character can choose to inflict half damage, quarter damage, a single point of damage, or no damage at all! A character must declare a pulled punch and the player must roll an 11 or better (1D20) to successfully pull his punch. A failed roll to pull means full damage is accidentally inflicted.

---

## Basic Martial Arts Equivalent to Judo

This is a basic, modern style of martial arts common among the high-tech communities like the Republic of Japan, **Ichtho** and **Takamatsu**. This is typically the basic hand to hand combat used by the Armed Forces and police of the Republic.

**Basic & Special Moves:** Body **block/tackle**, body flip/throw, break fall, disarm, roll with **punch/fall/impact**, strike, parry, dodge, and pull punch are available at first level. All bonuses are cumulative.

**Bonuses:** +2D4 S.D.C., +1 to M.E., and +1 to P.P.

### Level

- 1 Starts with two attacks per melee round. +3 to roll with **punch/fall/impact**, +3 to pull punch.
- 2 +2 to parry and dodge, +1 to strike.
- 3 +1 to body flip/throw and body tackle; +1 to disarm.
- 4 + One additional attack per melee and Karate-style kick (2D6 damage).
- 5 Critical body flip/throw on natural 19 or 20 (double damage).
- 6 +1 to strike, parry and dodge; +1 to body flip/throw.
- 7 Paired weapons and +2 to damage.
- 8 Jump kick and +1 to roll with **punch/fall/impact**.
- 9 + One additional attack per melee.
- 10 +2 on initiative and +1 to parry and dodge.
- 11 +1 to break fall and +1 to disarm.
- 12 Critical strike on a natural 18, 19, 20.
- 13 +2 to damage and **knock-out/stun** on a natural 19 or 20.
- 14 + One additional attack per melee.
- 15 Automatic body flip/throw.

---

## Aikido

**Aikido** is another martial arts form known to the modern characters living in the Republic of Japan, as well as many of the inhabitants on the islands of Japan. It has the greatest pacifist stance of all the martial arts. Its focus is entirely on defense, with absolutely no offensive maneuvers. In the 20th century, Aikido was created by drawing on techniques from Jujitsu, Judo, Karate and Kendo.

The Aikido martial artist can fend off the attacks of any and all who approach. Their goal in combat is to *subdue* opponents as quickly as possible. To do this they seize the leading part of the attacker's body, usually right at the wrist or ankle. At this point, one can either use the attacker's momentum in a flip/throw, or, by applying a joint lock, one can lead the attacker around into a helpless position on the ground.

**The following techniques are known at first level:** Body **block/tackle**, body flip/throw, break fall, disarm, holds, roll with **punch/fall/impact**, pull punch, kick attack (2D4 damage), and the usual, strike, parry and dodge.

**Bonuses:** +2D6 S.D.C., +1D4 to M.E., +1 to P.P., and +1 to P.E.

### Level

- 1 Two attacks per melee round; +3 to break fall, +2 to roll with **punch/fall/impact**, +2 to body flip/throw, and +2 to pull punch.
- 2 +1 on initiative, +2 to parry and dodge.
- 3 Automatic dodge and +1 to disarm.
- 4 + One attack per melee round and +1 to body flip/throw.
- 5 Critical body flip/throw on Natural 18-20 (double damage).
- 6 +1 to **parry/dodge** and +1 to body flip/throw.
- 7 Automatic flip/throw and +2 to pull punch.
- 8 + One additional attack per melee.
- 9 +1 on initiative and +1 to strike, parry and dodge.
- 10 Double existing P.P.E. (inner spirit) and +1 to disarm.
- 11 +1 to parry, +2 to dodge, and +1 to body flip/throw.
- 12 + One additional attack per melee.
- 13 +1 on initiative and +2 to body **block/tackle**.
- 14 Critical strike on a natural 18, 19, 20.
- 15 + One additional attack per melee.

---

## Jujitsu

This combat style is very pragmatic, using the philosophy of "whatever works." Techniques range from the assault of vital points, joint locks and throwing techniques. A trained master can reduce their victims into helplessness even if armed with daggers, sticks and guns. Any advantage that can be gained will be used by a Jujitsu practitioner without a second thought of fairness.

**The following techniques are known at first level:** Maintain balance, break fall, disarm, body **block/tackle**, body flip/throw, holds, roll with **punch/fall/impact**, pull punch, kick attack (2D4 damage), knee and elbow strikes (1D6 damage), and the usual, strike, parry and dodge.

**Limitation:** Characters of an honorable alignment cannot select this skill (i.e. can't be principled or aberrant).

**Bonuses:** +3D6 S.D.C., +2 to P.S., +1 to P.P.

### Level

- 1 Two attacks per melee round to start; snap kick (1D6 damage), knife hand (2D4 damage), +3 to roll with **punch/fall/impact**, +2 parry and dodge, and +2 to pull punch.
- 2 +1 to strike, **tripping/leg** hook and backward sweep kicks.
- 3 +1 on initiative and critical strike from behind.
- 4 + One additional attack per melee and +2 to damage.
- 5 Palm strike (2D4 damage) and drop kick.
- 6 Critical strike on a natural 18-20.

- 7 +1 to strike, +1 on body flip/throw and +1 to disarm.
- 8 + One additional attack per melee and +1 to maintain balance
- 9 Critical body flip/throw on natural 17-20.
- 10 Jump kick and leap attacks.
- 11 + One additional attack per melee and +2 to pull punch.
- 12 +1 on initiative, +1 to parry and dodge, and +1 to strike.
- 13 +2 to damage, +2 to pull punch, and +2 to break fall.
- 14 + One additional attack per melee
- 15 Death blow!

## Karate

There are a variety of different styles of karate. What follows is a variation of Japanese **Kyokushinkai** Karate — "the School of Ultimate Truth." The focus of this martial art is on aggressive combat and striking power, especially the power to break through solid objects, as well as an emphasis on rapid strikes and speed. Training is very hard and competitive.

**The following techniques are known at first level:** Break fall, body **block/tackle**, roll with **punch/fall/impact**, pull punch, kick attack (2D4 damage), karate kick (2D6 damage), karate punch (2D4 damage), knees and elbow strikes (1D6 damage), and the usual, strike, parry and dodge.

**Bonuses:** +3D6 S.D.C., +1D4 to P.S., +2 P.E., and +2 to Spd.

### Level

- 1 Two attacks per melee round to start; snap kick (1D6 damage), knife hand (2D4 damage); +1 on initiative, +2 to roll with **punch/fall/impact**, +2 parry, +1 to dodge, +1 to break fall and +2 to pull punch.
- 2 +1 to strike, **tripping/leg** hook and backward sweep kicks.
- 3 +One additional attack per melee round and +2 to damage.
- 4 +1 on initiative, +1 to disarm, and roundhouse kick (3D6 damage).
- 5 Power punch and palm strike (2D4 damage).
- 6 + One additional attack per melee and +2 to pull punch.
- 7 Power kick, wheel kick, and +1 to strike, parry and break fall. 8 Critical strike on a natural 18-20, critical strike from behind and death blow on a natural 20.
- 9 + One additional attack per melee and +2 to damage.
- 10 Jump kick and leap attacks.
- 11 +1 on initiative, +1 to parry and dodge, and +1 to strike.
- 12 + One additional attack per melee and +2 to pull punch.
- 13 Death Blow!
- 14 +2 to damage, +2 to pull punch, and +2 to break fall.
- 15 + One additional attack per melee.

## Kendo

Kendo is a martial art developed around the art of swordsmanship. Consequently, it deals with balance, striking, parrying and slacking.

**The following techniques are known at first level:** Disarm, break fall, roll with **punch/fall/impact**, pull punch, karate punch (2D4 damage), kick attack (2D4), knees and elbow strikes (1D6 damage), and the usual, strike, parry and dodge.

**Bonuses:** +2D4 S.D.C., +1 to P.S., +1 P.P. and +2 to Spd.

### Level

- 1 Two attacks per melee round to start; knife hand (2D4 damage); +1 on initiative, +2 to roll with **punch/fall/impact**, +1 to disarm, +1 parry (punch attacks), +2 to parry with sword or staff (in addition to W.P. bonuses), +1 to dodge, +1 to break fall and +2 to pull punch.
- 2 +1 to strike and paired weapons.
- 3 +One additional attack per melee round and +2 to damage.
- 4 +1 on initiative, +1 to disarm, and +1 to parry.
- 5 **Tripping/leg** hook and backward sweep kicks.
- 6 Power punch and palm strike (2D4 damage).
- 7 + One additional attack per melee and +2 to pull punch.
- 8 Critical strike on a natural 18-20, critical strike from behind and death blow on a natural 19-20.
- 9 + One additional attack per melee and +4 to damage.
- 10 Automatic dodge.
- 11 +1 on initiative, +1 to strike, and +2 to break fall.
- 12 + One additional attack per melee and +2 to pull punch.
- 13 Jump kick and leap attacks.
- 14 Death Blow!
- 15 + One additional attack per melee.

## Ninjitsu, Teng-jutsu & Zanj Shinjinken-Ryo

These three forms of martial arts are unique and taught only to members of a particular clan, organization or **occupation/O.C.C.** The occasional, rare exception will be indicated under the O.C.C. that allows such training, like the ronin. The exact hand to hand description can be found under each respective **O.C.C./R.C.C.** description.

## Other Forms of Modern Combat

The four styles of combat presented in the **Rifts RPG**, hand to hand *basic*, *expert*, *martial arts* and *assassin*, may also be known to characters in **Rifts Japan**. This is especially true of city folk, pirates, sailors and visitors from other lands.





---

---

# Mystic Martial Art Powers

---

---

Adapted from Erick Wujcik's *Ninjas & Superspies* RPG.

## Mystic Arts of Invisibility

Disguise  
Evasion  
Hiding  
Mystic Invisibility  
Stealth  
Vanishing

## Body Hardening Exercises

Chi-Gung  
Dam Sum Sing  
Iron Hand  
Kick Practice  
Stone Ox  
Kangeiko & Shocha Geiko  
Wrist Hardening

## Zenjoriki Powers

Calm Minds  
Karumi-Jutsu  
Two Minds  
Vibrating Palm  
Vital Strike Atemi  
Withering Flesh Atemi

---

## Arts of Invisibility

---

There is more to the art of invisibility than moving quietly and sticking to the shadows. Mystic ninja and other secretive martial artists learn from the Japanese Kabuki puppet theater, where handlers, although dressed in black, are in clear view and yet manage to vanish. For the puppeteers, as for other practitioners of the arts of invisibility, stealth combines mental silence and absolute physical control over the body's movement, breathing and heartbeat.

### Art of Stealth or Pi Mi Hsing Tung

This is the martial art equivalent to the skill *ofprowl*. Using stealth, a character can move silently and out of sight of observers. So long as the character is in the dark and unsuspected, this is done *automatically*, without needing to roll the dice for a successful prowling. If the **character's** area is subjected to inspection (for example, a guard tower turns a spotlight on the character or investigators are scrutinizing the area) then the chance to remain undetected is 43% +3% per level of experience.

The character also learns **Jung Hua**, the art of melting into the water. This gives one the ability to silently move out of water, into water, and through water. Base chance is 50% with a +3% per level. Note that the character must have the swimming skill in order to use this ability while in deep water.

### Art of Hiding or Inpo

Training in the art of hiding involves studying the essential characteristics of all kinds of objects. For example, how does one move when hiding in long grass so as not to be different from the surrounding blades? The character learns to become *one* with another object, remaining motionless when necessary and moving **imperceptibly**. There is normally *no chance that the character will be detected*. However, if the area is well-lit and subject to careful inspection, then the character's chance of remaining undetected is 60%+3% per level.

Note that this ability works only as long as the character stays motionless. However, the character can stay motionless for hours, even days, using this technique.

### Art of Evasion or Hsing Tsia

Ever play a kid's game where you try to stay behind somebody, turning as they turn, constantly trying to stay out of view, until they're turning and twisting like a dog chasing its tail? That's what the mystic art of evasion is all about. This ability works *automatically* if the enemy is unaware of the character's presence. If the enemy *knows* or *suspects* that someone is behind him, then the character must roll to avoid being seen. Characters with this skill have a 50% chance of success +3% per level of experience.

This is a particularly deadly ability if the character uses *critical strike* or *knockout attacks* from behind. The character can attack continuously so long as he can remain unseen (roll under skill above). This *does not work* if the victim has a friend handy who can see the assailant and yell, "look out," or if the intended victim backs up against a wall. **Note:** This power only enables the ninja to remain hidden behind the person he is stalking. Others around the pair (victim and his shadow stalker) can see them *both* clearly. Furthermore, if the intended victim ever catches sight of his evasive **stalker**, the power is negated and there's no chance of returning to the *evasion* power unless one can vanish as well (see next ability).

### Art of Vanishing or Sun Shih K'an Chien Chih

From clear view, even in the middle of combat, the character has the ability to simply disappear! The way it works is sort of like a sleight of hand magic trick. The character distracts the observer and **instantly falls** to the ground, rolls to the side, or otherwise vanishes from sight.

**Base Skill:** Chance of success at vanishing depends on conditions. In darkness (full night), with many obstructions, the character has a success ratio of 85% plus 1% per level of experience. However, there are a number of cumulative penalties based on environment and light: -10% in fair light, -20% in strong light, -15% on clear, flat, featureless ground, -20% when cornered with no place to go but forward (or up, or down).

For example, Jet's say two characters are fighting *in* the middle of a lit baseball diamond (strong light and clear, flat, featureless ground). A successful vanish for a first level character would require a roll of 50 or less on percentile dice. If the roll is successful then the character has just disappeared for an instant (one melee action). And that's enough to start using the art of evasion or some other ability.

**Duration:** One melee action; roughly two or three seconds. The act of vanishing counts as one melee **action/attack**.

## Art of Disguise or Hensho-Jutsu

This is far more than the simple use of make-up and clothing. The art of disguise trains the character to radically change posture, stance, walk and expression, all those clues that people usually use for identifying each other. Consider how you usually look at someone, generally you don't study them, you simply glance at them. And you don't have to see them from the front, you can spot most people you know just by the way they walk and the way they hold themselves.

The art of disguise gives the character the ability to imitate the movements and postures of many different people. For example, to have the walking and sitting position, groans, and non-verbal complaints of a truck driver exhausted from hours on the road.

Using this ability means being able to change instantly. Here's an example, two policemen are chasing a woman in ordinary dress. She goes around the corner and the police run after. Just around the corner they pass an old woman, she **too-slowly** tries to move out of the way and they easily side-step her. A few feet later they discover they've lost their quarry, never realizing that the *old woman* was the person they were searching for, she had the same clothes, the same face, but her *visual clues* were so different that they completely missed her.

The character is able to blend into a large crowd without even trying hard; this trick works *automatically* in large crowds (100 or more people). However, in smaller crowds or areas with very few people scattered about, a roll for success is required. **Base Skill:** 50% +3% per level of experience; -40% if the disguised character is stopped and specifically questioned or searched. **Note:** Combining the art of disguise with the *disguise skill* enables the character to create virtually fool-proof disguises (96% ability to conceal true identity and 88% chance of physically impersonating a specific person or occupation — to do the latter requires hours of study and practice).

Incidentally, this won't work if the character is dressed in some outrageous manner. For example, someone in a ninja outfit is still going to look like a ninja no matter what stance they take. However, it takes just a moment to whip off the hood, or change the garments in some other way. This is one reason most true ninjas avoid wearing heavy, plate body armor or carrying bulky weapons.

## Art of Mystic Invisibility or Chi Zoshiki

The character learns to draw upon his own mystic energy to mystically cloud the minds of observers. The character has no other control over the deceived person — the power is oriented toward the single purpose of deception.

The most amazing thing about this ability is that the character can simply stand in full view, stare into the eyes of the enemy, and vanish — simply cease to exist! The character must *use one P.P.E. point* for every melee round (15 seconds) he remains invisible. Obviously, this means it's a good idea to hide in a more conventional way before all the P.P.E. points are gone. To simultaneously cloud the minds of 2-8 people, the character must expend 4 P.P.E. points per melee round. More than eight requires the expenditure of 12 points per melee round.

The amount of concentration necessary to use this power requires the character to turn visible to engage in combat or to perform any skills other than the arts of invisibility.

**Important Note:** This ability also automatically shields the character's P.P.E. from magic and psionic "detection" and from being siphoned away. This means an opponent cannot use the magic or psionic powers of detect magic, detect psionics, or see the invisible to locate the

invisible character! Likewise, those whose minds have been clouded cannot "see" the character with optical enhancements or motion detectors — their minds believe the character has completely vanished and is no longer present. A check with such machines will confirm that the ninja is gone.

**Saving Throw:** Those whose minds are being temporarily clouded must roll a 19 or higher to save. A failed roll means they cannot see the character. A successful save means the mind clouding power didn't work and the character can still be seen. Roll only once for an entire group (saves time). The character can try to turn invisible once per melee round.

---

## Body Hardening Exercises

---

Martial artists are often fanatical about building up their bodies. Diving under the ice of frozen lakes in order to get a swim, chopping wood with bare hands until they bleed, and fasting in the wilderness until coming close to death. These are all signs that martial artists are serious about hardening up their frail flesh. In this case, the *mystic arts* of body hardening produces some spectacular and superhuman **results!**

**Mega-Damage Body Power:** In addition to the powers and bonuses listed below, each of the body hardening exercises enables the character to draw on mystic energy, at a cost of 5 P.P.E. points (unless stated otherwise), and transform the S.D.C., not hit points, of their bodies into mega-damage! Duration of the M.D.C. transformation is one minute (4 melee rounds) unless stated otherwise. The change is instant, a simple matter of willpower and mentally manipulating magic energy.

**Note:** All bonuses and abilities are cumulative — characters can have several abilities.

### Stone Ox

The ultimate body hardening exercise, the character practices taking damage by sitting under waterfalls, taking punches and kicks from fellow students, and chopping outrageous amounts of wood.

**Bonuses:** +2 to P.S., +1 to P.E., +4D4x10 S.D.C. in addition to any O.C.C. and skill bonuses. Furthermore, the character fatigues at half the normal rate (greater endurance), and can lift and carry 50 times the normal weight **capacity!**

### Combination of Kangeiko & Shochu Geiko

**Kangeiko** is winter training in martial arts, taking ice-cold showers under freezing waterfalls. **Shochu Geiko** is hot summer training, working out unprotected under a blistering tropical sun. Characters with this skill can resist severe weather unprotected for a full day without ill effect. For example, a **Kangeiko-trained** character stranded in the arctic snow without winter clothing would be just fine (suffering no damage) for a full 24 hours.

**Bonuses:** +3D6 to S.D.C., +1D6 to hit points, +1 to P.E., invulnerable to *stun* and *paralysis* attacks, and fire and cold based attacks do half damage, including magic and plasma. Impervious to the withering flesh **atemi** power.

### Iron Hand or Kanshu

This is the development of the "Penetration Hand," a toughened hand that will not take damage from hitting hard objects. The hands are plunged into barrels of rice, then sand, then pebbles. This constant training toughens the hands enormously. The martial artist can break things

with hand strikes and take no damage. Furthermore, the character can use his *hands* to pick up burning coals or immerse them in boiling oil, lava or fire without suffering pain or damage. Even magic fire and plasma do half damage to the *hands*.

#### Damage from Iron Hand Punches:

Normal Punch — 2D6 S.D.C.

Karate Punch — 4D6 S.D.C.

Knife Hand or Palm Strike — 1D6 M.D.

Power Punch — 2D6 M.D. (counts as two melee actions); does double normal damage if the character with Iron Hands is a mega-creature that inflicts M.D. to begin with, like an oni lord.

**Note:** The character can pull his punches to inflict S.D.C. damage rather than mega-damage.

**Bonuses:** +4 to damage on all hand strikes.

## Chi-Gung

### Mega-Damage Skin

Part Chi (inner spirit), part physical training, part mysticism (P.P.E.), *chi-gung* results in a toughening of the skin so that blades cannot cut it and arrows cannot pierce it! Another aspect of Chi-Gung is being able to do spectacular demonstrations. These involve resisting sharp blades, sword points and walking on burning shards of jagged glass without harm.

In terms of the game system, the character's skin has a natural A.R. (Armor Rating) of 18 and he has at least 100 S.D.C. points. The S.D.C. and hit points of that tough skin can be turned into a mega-damage material whenever *chi-gung* focus is used.

**P.P.E. Cost:** 1 point per every two minutes (8 melee rounds).

**Bonuses:** +1 to P.E., +2D6 to hit points, and +90 to S.D.C. in addition to any O.C.C. and skill bonuses.

## Dam Sum Sing

A combination strength and endurance building exercise. Practitioners repeatedly strike each other with full power strikes and blocks to build strength and resistance.

As a result, all damage from punches, kicks, falls, impacts, explosions and even projectiles (arrows, bullets, rail gun rounds, etc.) is reduced by half.

**Bonuses:** +1 to P.E., +20 to S.D.C. and +2 to roll with punch/fall/impact (halving damage again).

## Wrist Hardening

The wrists and joints are often the weakest parts of the body, so this mystic training makes them **superhumanly** strong. Characters with this power are +5 to escape from all holds and can lock their joints, requiring the equivalent, combined strength of double the character's natural P.S. to bend them! Thus, it is likely to take two or more strong men to bend the character's arms or legs or break something loose from his grip or embrace. **Bonuses:** +1D6 to P.S., +4 to maintain balance, and the character can parry (normal bonuses apply) attacks, even mega-damage attacks, with his wrists!

## Kick Practice or Chagi

Repeated kicks at all heights. The character develops the flexibility to do the "splits," to kick straight up over the head, and to jump up, kick something directly overhead, and return to a standing position.

#### Damage from Chagi Kicks:

Normal Kick Attack — 4D6 S.D.C.

Karate and Wheel Kick — 6D6 S.D.C.

Snap Kick — 2D6 S.D.C.

Jump Kick — 3D6 M.D.

Roundhouse Kick — 6D6 M.D.

Power Kick — 5D6 M.D. (counts as two melee actions); does double normal damage if the character with Chagi is a mega-damage creature that inflicts M.D. to begin with, like an oni lord.

**Note:** The character can pull his kick to inflict S.D.C. damage rather than mega-damage.

**Leaping:** The character can leap amazing distances from a standing or crouched position. 10 feet high (3 m) +2 feet (0.6 m) per level of experience from a standing position! Add 10 feet to lengthwise leaps with a running start.

**Bonuses:** +1 to strike, +3D6 to Spd.

---

# Zenjoriki Powers

---

Zenjoriki are supernormal "Spirit Powers" that draw on mystic energy and might be considered one aspect of Japanese magic. All *zenjoriki* powers are attained through the mastery of martial arts, meditation and inner spirit (*chi*). All require the conscious or subconscious channelling of mystic energy (P.P.E.).

## Calm Minds

**Range:** 120 feet (36.5 m)

**Duration:** It lasts for three minutes (12 melee rounds).

**Saving Throw:** Special; each character must make a save vs calm of a 17 or better on a twenty-sided die (M.E. bonus can be added).

**P.P.E.:** 10

Using this ability is like spreading oil on the troubled waters of an angry mob. Everyone affected (friends and foes alike) will immediately stop any attacks (although they can defend as normal or flee) and will be unable to resume offensive actions until the calm minds is over. Other than engage in combat, those affected by calm minds can do anything else they wish.

It only takes one melee action (3 seconds) to perform this ability. After that, the effects continue automatically for the full three minutes. However, if the martial artist using the calm minds makes any kind of attack himself, then its influence is instantly dispelled and everyone in the area can immediately resume their attacks.

Usually the calm minds is used to give the characters enough breathing space to either talk ("Hey, we came to negotiate, not **fight!**"), run or buy some time waiting for the cavalry to show up. It's quite possible that combat can start up again after the calm minds is over, and calm minds can't be used again with the same group for another hour. This power also dispels fear and any other hysterical emotions no matter what the cause.

## Karumi-Jutsu

**Range:** Self

**Duration:** It lasts for three minutes (12 melee rounds) per level of experience.

**Saving Throw:** Not applicable.

**P.P.E.:** 10

The character has a mystic ability that allows his **body's** weight to change as he wills it. There are only a few restrictions. First, it only works on the character's *own* body, not any possessions or clothing. Second, it works only when invoked, and definitely does *not* work if the character is in combat or rendered unconscious. It requires total concentration, and the character can perform no other attacks, defenses or actions while using the power. Karumi-Jutsu allows for the following abilities:

**Falling:** The character can fall from any distance and land on his feet without suffering any damage.

**Jumping:** The ability to jump great distances, up to 10 times the character's normal distance (at least 40 feet/12.2m).

**Climbing:** The character can climb any surface like an insect without fear of falling.

**Treading Lightly:** The character can walk across delicate surfaces like a spider's web, thread, thin tree branch, or extremely fragile bridges without fear of collapse. Likewise, the character can walk on objects as delicate as china teacups or leaves without causing damage or disturbance.

## Two Minds

**Range:** Self

**Duration:** It lasts for three minutes (12 melee rounds) per level of experience.

**Saving Throw:** Not applicable.

**P.P.E.:** 30

By deliberately separating the two parts of the soul, the character is able to do two things at the same time! And, in some circumstances, the character can even **be** in two places at once.

The powers of the two minds is based on the principle that the soul consists of two parts, the primary and the secondary minds. The primary is the *Hun* (Cloud Soul), which is more analytical and is really the consciousness. The secondary part of the soul is the *Po* (Bone Soul), which is the more instinctive, animalistic aspect, and consists more of drives and desires than of thought. Split apart, the two pieces are capable of acting independently, just as if the character were suddenly split into two minds.

One of the most common applications of two minds is that of splitting into two parts when in combat. One part (usually the Po) controls the body's actions, while the other part (generally the Hun), works on tactical problems, yelling out commands, or engages in simultaneous psionic or magic combat or long-range attacks (-4 to strike).

However, the big thing to bear in mind is that the two parts of the soul are anything but equal. Each is a distinct aspect of the character, each with different parts of the character's skills, strengths and weaknesses. Here are the respective abilities, and disabilities, of the Hun and the Po:

**Hun Abilities:** Speech, analytical thought, mathematics, map-reading and direction finding, manipulation of **magic/P.P.E.** and **psionics/I.S.P.**, and all thinking skills. All the *smarts* and compassion of the character usually ends up in the Hun. The spirit mind appears as a wispy ghost or phantom with a mist-like body. The Hun possesses all the mental attributes at full strength but physical ones are at half.

**Hun Inabilities:** Combat, martial arts, P.P.E. and **I.S.P.** recharging or gathering, danger sense, artistic sense, taste, and smell. Frankly, the Hun is a clumsy being, barely capable of walking, much less fighting.

**Po Abilities:** The Po can engage in combat with all bonuses from attributes, physical skills and martial arts, plus weapon proficiencies, pilot skills (if the character has pilot aircraft, the Po can physically **takeoff**, fly, and land the airplane), **magic/P.P.E.** and **psionic/I.S.P.** regeneration, and the senses of taste, scent, and esthetics. The Po also retains control of the physical body and has all the physical attributes at full strength, but mental ones are at **half**.

**Po Inabilities:** Speech (in other words, the Po can't **talk!**), thinking skills (if the character has pilot aircraft, the Po would not understand instrument danger signals, and couldn't follow a navigational plan or map), magic and psionic abilities, and control over emotions.

**Note:** The hit points and S.D.C. of the character is split 50/50 between the spirit and the flesh.

Once split, the roles of the hun and **po** can't be reversed. So, for example, if the Hun is off exploring while the Po is in charge of the body, the character can't switch them around without bringing them back together and starting all over.

## Vibrating Palm

**Range:** 120 feet (36.5 m)

**Duration:** It lasts up to 10 melee rounds (two and a half minutes).

**Damage:** Special; attacks against human or S.D.C. structures inflict S.D.C. damage. Attacks against mega-damage beings or structures inflict mega-damage. 512 point maximum, by the end of the 10 melee rounds of an uninterrupted attack.

**Saving Throw:** Not applicable.

**P.P.E.:** 70

The vibrating palm attack shatters any material object by creating sympathetic vibrations that are ultimately self-destructive. The first melee round of a vibrating palm attack will result in disrupting just 1 point of S.D.C. (or M.D.C.). However, each succeeding melee round doubles the amount of disruption damage. The second melee round destroys 2 points of **S.D.C.**, the third round gets rid of another 4 points, the fifth round wipes out 8 points, and by the tenth melee round, the character is able to disrupt 512 points of S.D.C. — this is the maximum damage amount. To inflict more, the character must use another vibrating palm attack and expend 70 P.P.E. points.

Vibrating Palm requires the character's complete and undivided attention. No other attacks, actions, or defenses can be performed for the full duration of the attack. The character can't even talk with or look at another object or person without withdrawing from the vibrations. Likewise, knocking the character unconscious, blinding him or even tackling him will interrupt the magic.

If a vibrating palm is stopped or interrupted, all vibrations stop and no more damage is added. Starting up again means starting back at the beginning, with 1 S.D.C. on the first melee round.

## Vital Strike Atemi

**Range:** Punch or kick attack; self.

**Duration:** Instant

**Damage:** Special; this attack goes directly to hit points, bypassing any physical S.D.C.

**Saving Throw:** Special; the victim can attempt to reduce the amount of damage by half by making a successful roll with **punch/fall/impact** (the victim must better his attacker's roll to strike or suffer full damage).

**P.P.E.:** 20

**Note:** Characters with the Stone Ox body hardening power are immune to the vital strike, and those with Chi-Gung M.D. flesh take half damage without having to roll to save vs impact.

This deadly magic is used to kill an opponent with vast amounts of natural, physical S.D.C. To use the magic, the character must strike his opponent with a punch, kick or hand weapon, inflicting the normal amount of damage from a punch, kick or hand-held weapon (sword, spear, etc.; not applicable to thrown weapons or arrows) *direct to hit points!* When all hit points are reduced to zero or below, the character falls into a coma, regardless of his remaining S.D.C. Note that the vital strike attack cannot be used to inflict S.D.C. point damage, but does inflict normal damage against body armor or inanimate objects. Its magic cannot pass through M.D.C. environmental body armor, power armor or vehicles (it *is* effective against non-environmental body armor).

The vital strike can also be used against mega-damage supernatural beings such as oni and dragons. In this case, each successful vital strike inflicts the mega-damage equivalent of the blow x2. For example, if a punch normally does 1D6 S.D.C. the vital strike does 2D6 M.D., if the sword normally does 3D6 S.D.C., the vital strike does 6D6 M.D. and so on.

## Withering Flesh Atemi

**Range:** Punch or kick attack; self.

**Duration:** Instant

**Damage:** Special; this attack literally knocks out a victim's natural S.D.C. (up to 100 per strike), leaving the person vulnerable to attacks directly to hit points.

**Saving Throw:** Special; the victim can attempt to reduce the amount of damage by half by making a successful roll with **punch/fall/impact**(the victim must better his attacker's roll to strike or suffer full damage).

P.P.E.: 25 if the punch or kick strikes, 5 P.P.E. are used up if the attack misses.

**Note:** Characters with the Kangeiko & Shochu Geiko body hardening power are immune to the withering touch, and those with Chi-Gung M.D. flesh take half damage without having to roll to save vs impact.

This deadly magic is used to quickly diminish the physical endurance/S.D.C. of powerful warriors. To use the magic, the character must strike his opponent with a punch or kick. Instead of inflicting the nor-

mal damage, the withering flesh strike reduces the warrior's S.D.C. up to a total of 100 points per strike. Once all or most of the S.D.C. is gone, conventional attacks can be used to whittle away hit points. Note that the withering flesh attack cannot be used to inflict hit point damage, only to a living being's physical S.D.C. points. Likewise, this attack cannot damage body armor or inanimate objects and cannot pass through M.D.C. environmental body armor, power armor or vehicles (it is effective against non-environmental body armor).

The withering touch can also be used against mega-damage supernatural beings such as oni, dragons and even gods. In this case, each successful withering flesh strike inflicts **2D4x10** mega-damage (only **1D4x10** M.D. against elementals). Up to *half* of the creature's M.D.C. can be reduced by withering flesh before the power becomes ineffective (can only reduce the monster's M.D.C. by half). M.D. inflicted by withering flesh cannot be regenerated by any means for one full hour.

---

# Monsters of Japan

---

By Kevin Siembieda & Patrick Nowak

## Monsters

Oni of the One Hundred

Oni Master

Oni Mystic

Goblins

Goblin: Spiders

Japanese Imp

Sura-Kappa

Hannya

## Dragons

Shikome Kido-Mi

Kumo-Mi

Asama-Tatsu

## Oni

### One Hundred Demons

The Japanese word for demon is "oni." In Japanese myth there are literally hundreds of different types of demons, however, most do not have a specific name and are simply referred to as "oni." Frequently, an oni will be identified by its appearance, "the three-armed oni," "lion head oni," "fire oni"; or by its disposition, such as, "wicked and mocking;" and/or by its activities, "a demon most foul," "child-stealing goblin," "the angry oni," "destroyer of temples," or "fiend of the wind." Oni may also be identified by its associations with others, such as "the demon of the witch Yoko Sekien," or "protector of the god ..." and so on.

In many ways, oni represent the "nameless terror" of the night and human fears. Consequently, they are always monstrous, ugly or frightening to behold. The reference to "one hundred demons" refers to the many strange appearances of the average oni. Some have the heads of lions or animals with large sinister eyes, others look human but have misshapen facial features, usually a large, flat or bulbous or pointed nose and a large mouth filled with crooked teeth. Many are exceedingly hairy and may even have manes of wild, tangled, black or red hair that cover not only the head but the entire back as well. Another common trait of Japanese demons is their large, clawed, two-toed feet, and at least half have horns of some kind. Many are hunchbacked or have strangely shaped bodies and muscular limbs, while a third have animal features or qualities.

Unlike the giants of many Western myths, most oni are small, goblin-like beings, who stand four to five (1.2 to 1.5 m) tall. There is the occasional towering giant, but it is more likely for one to encounter a small demon.

The most common oni, known as the **Oni of the One Hundred**, are dull-witted beings who delight in murder, torture, kidnapping, robbery, vandalism and causing suffering and mayhem upon all weaker beings. They are especially bold in large numbers, yet even in large groups these demons can be frightened away by feats of magic, great strength and courage. Typically, if the most powerful in the group (1D4+1 unofficial leaders/rabble-rousers) are defeated, incapacitated, tricked or slain, the rest will flee. When one to four are encountered, the right approach can cause them all to be bluffed, bullied, or frightened away. However, don't be fooled, each demon or group of these supernatural predators must be judged on its own merits. There are many oni who are not frightened easily and who will fight to the death! *All* are vindictive, foul-tempered, liars who will cheat an ally, or stab a captor in the back the first opportunity he gets. They love to torment others and deface the things that mortals view as beautiful or holy.

Oni represent the largest portion of the monster population of Japan. Tens of thousands of these vicious creatures inhabit the wilderness areas throughout the islands and dominate the land known as *The Zone*. Oni are mystical beings, originating from another dimension that has been linked to Japan for thousands of years. In ancient times, only a few hundred inhabited Japan at any given time. They are the creatures responsible for ancient tales of demons, ghosts, faeries and dragons. With the advent of the Great Cataclysm, Japan seems to have become a breeding ground for oni and monsters. When the Rifts erupted they seized their chance, flocking to Japan by the thousands.

In the wilderness, oni live as primordial raiders, looting and killing at every opportunity. They love to intimidate helpless and weaker beings, so they frequently capture and enslave humans, sometimes conquering and ruling entire villages! They are also notorious for kidnapping children and women as slaves and for diabolical purposes, such as blood sacrifices, torture, terrible pleasures and for food, like cattle. Those condemned to hard labor and frequent beatings consider themselves lucky.

*The Oni of the One Hundred* wander the shattered landscape in small tribal war bands to raid villages, attack travelers, and even invade the great reborn cities in the Republic of Japan! The only authority these monsters seem to respect is *power*. Thus, the strongest warriors, the boldest priests, and practitioners of magic are considered their natural enemies. They also fear the tengu, gods and "man's technology," specifically power armor, cyborgs, robots and energy weapons. They also love "man's technology," and frequently steal and use mega-damage body armor, **vibro-blades** and energy weapons; thankfully, they are too



ignorant and impatient to learn to operate power armor, computers and vehicles.

Among the oni tribes, clans and war bands, the strongest warrior or most powerful wielder of magic is accepted as their leader. The vermin also associate with other evil beings who have power and/or promote war and wanton destruction. These non-oni creatures include oni masters, greater demons, dragons, godlings, **gods**, a host of other dimensional beings and even evil *human* sorcerers, pirates, mercenaries and warlords!

When a leader dies or disappears, the clan is thrown into a state of disarray. Until a new leader is appointed, they are without purpose or direction. Immediately, subordinates within the tribe will step forward to claim the vacant position of leader or war chief, each challenging the other and engaging in combat. Ultimately, the strongest or most cunning triumphs and takes the mantle of leadership. However, his or her power may be challenged from those within the group as well as from new arrivals looking to join or take over the group. Many wizards, human warlords, pirates, non-humans and supernatural beings acquire oni minions by defeating the tribal leader and the handful of others who may rise up to challenge him. Of course, the **oni's** loyalty is *conditional* and would-be leaders may challenge, or strike at, the current leader whenever he may appear to be vulnerable. Likewise, they will cheat, steal **from**, **backstab**, and malign their leader, unless they are terrorized into submission — the more loyal the oni minions, the more powerful and cruel their leader(s) is likely to be.

Although humans and other mortals are the oni's favorite targets, they will attack anybody they believe is weaker than them. This includes other oni clans. Demonic tribes are constantly at war amongst themselves, competing for supremacy. And "supremacy" is a good

word, because most oni are megalomaniacs who are never satisfied with what territory or wealth they possess. It is commonplace to hear an oni bellow that he is, "the greatest warrior in the world," or "I shall rule all of Japan," or "the world shall be mine."

As carnivores, the oni will eat any **humanoid** or animal they kill, even other demons, although human flesh is preferred, as well as animals/cattle taken or stolen from humans (somehow, taking food away from humans has more flavor than animals trapped and prepared by themselves). They also have a weakness for alcohol, which can often be used as a bribe to escape the creatures or to gather information.

For the most part, oni lack any formal training, but are naturally adept fighters who make up for their lack of skill in sheer physical strength, natural magic powers, cruelty and viciousness. Strategies are simple by necessity because most of these creatures are dull-witted — although their sheer brutality results in a high rate of success. The oni's supernatural nature makes them mega-damage creatures with superhuman strength. However, many like to imitate humans so some will dress in human clothing or wear armor and use swords and other **weapons**. To this end, oni masters have developed a secret ritual through which they can enchant their melee weapons to inflict mega-damage and their armor to have a mega-damage capacity. Preferred weapons include clubs, swords, and axes. Captured **vibro-blades**, rune weapons and magic weapons or armor are prized treasures. Although an increasing number are beginning to use human body armor, energy weapons and rail guns (as the Republic of Japan has feared), less than **15%** rely on such weapons, and even these have only the most rudimentary knowledge of them. To most oni, human technology remains an enigma that they care not to unravel. Most fight with tooth and claw.

---

## Tables for oni creation

Roll once on each unless indicated otherwise.

---

### General Body Shape

- 01-20 Perfectly human
- 21-50 Broad, muscular human.
- 51-60 Skeletal human.
- 61-65 Lumpy blob like a snail.
- 66-70 Looks like a buddha (fat and bald)
- 71-80 Toad; large, round, fat and flabby with no neck.
- 81-90 Bird; barrel chested, broad upper body, narrow lower abdomen, short thick neck.
- 91-95 Humanoid but giant, 8 feet (2.4 m) +1D4 additional feet (0.3-1.2 m).
- 96-00 Fish; long body, complete with scales, fins and tail.

### Oni Head Shape

- 01-05 Wild Boar; +2 horror factor
- 06-15 Lion/cat; +2 horror factor
- 16-30 Human; no horror factor bonus.
- 31-40 Skeletal human with sunken features; +2 horror factor.
- 41-45 Monkey; +1 horror factor.
- 46-55 Large and round like a melon; +3 horror factor.
- 56-60 Fish-like; +2 horror factor.
- 61-65 Snake-like; +3 horror factor.
- 66-70 Bird-like; +2 horror factor.
- 71-80 Human but looks like a *rotting* skeleton; +4 horror factor.
- 81-90 Neanderthal-like with a basic but larger, thicker human skull, thick eyebrow ridges and square chin, +1 horror factor.
- 91-95 Fox/canine-like: +2 horror factor.
- 96-00 Rat-like; +2 horror factor.

### Oni Nose

- 01-10 Normal human nose.
- 11-20 Bulbous nose three times larger than a normal human.
- 21-30 Pointed nose three times larger than a normal human.
- 31-50 Large, wide, flat nose like that of an ape, two times larger than a normal human.
- 51-60 Bird nose; can be shaped like a hawk or sparrow.
- 61-70 Animal snout, like that of a boar, hog or fox.
- 71-80 Tiny nose; can be any of the above types (choose or roll) but two times smaller than normal.
- 81-85 Snake nose; two small holes or slits above the mouth.
- 86-90 Rat nose.
- 91-00 No nose; not even an opening for one.

### Oni Eyes

- 01-10 Large human eyes with a wild or crazed look to them.
- 11-20 Huge almond-shaped eyes that glow red like a fire or sparkling gold, yellow, amber, or orange.
- 21-40 Large round eyes that are white, pink, pale blue, green or clear like a crystal ball.
- 41-50 Small eyes that are an unnatural red, yellow, or black.
- 51-60 Snake eyes that sparkle gold or silver.
- 61-70 Bird eyes the look like jade.
- 71-80 Normal human eyes.
- 81-90 Roll again for eye shape (or pick one), but has four of them.
- 91-00 One large round eye that is a pale blue or violet.

### Oni Mouth

- 01-10 Large toad-like mouth filled with large, flat teeth in a perfect row; flabby lips. 2D4 M.D. from bite.
- 11-20 Human mouth and crooked teeth. 1D4 M.D. from bite.
- 21-30 Human mouth with fangs and sharp teeth. 2D4 M.D. from bite.
- 31-40 Human mouth but twice as large as normal with large, pointed, crooked teeth. 3D4 M.D. from bite.
- 41-50 Large monkey-like mouth filled with sharp teeth and large fangs. 3D6 M.D. from bite.
- 51-60 Large toad mouth, no lips, just a long slit for a mouth filled with tiny, sharp teeth. 2D6 M.D. from bite.
- 61-70 Canine-like mouth and short muzzle filled with canine teeth and fangs. 3D6 M.D.
- 71-80 Large mouth with flabby, quivering lips, filled with large, flat, crooked teeth. 2D4 M.D. from bite.
- 81-90 Large mouth with flabby, quivering lips, with NO teeth. One point of mega-damage from bite.
- 91-00 Tiny slit for a mouth, half the size of a normal human; no lips, tiny teeth and a thin snake's tongue. 1D4 M.D. from a bite.

### Oni Arms & Hands

- 01-20 Perfectly human. No claws; 1D6 M.D.
- 21-30 A pair of large, oversized, muscular arms (3D6 M.D.) and a third, smaller arm with two clawed fingers and a thumb (2D6 M.D.; +1 attack per melee round).
- 31-45 Muscular human arms with clawed hands that have two fingers and a thumb. 3D6 M.D.
- 46-56 Thin and gnarled arms, muscular but misshapen. The hands are skeletal with long clawed fingers. 2D6 M.D.
- 57-67 Three-fingered claws (and a thumb) with muscular arms. Monkey-like in shape and length. 2D4 M.D.
- 68-75 Squirrel or rat-like in shape and length, short and spindly with small articulated hands and fingers. 1D4 M.D.
- 76-85 Five arms of equal size and proportion; adds one additional attack per melee round. 3D6 M.D.
- 86-95 Bird-like clawed hands and powerful arms. 3D6 M.D.
- 96-00 Octopus-like tentacles instead of arms; twice as long as human arms; 2D6 M.D. from whip attack, +4 to **entangle/grab/hold**.

### Oni Legs

- 01-15 Perfectly human. No claws. 5D6 speed attribute.
- 16-25 Monkey-like in shape and length: short, stubby legs; walks in a waddling manner and lopes on all fours when running. Prehensile feet adds +10% to balance and climbing. 4D6 speed attribute.
- 26-50 Classic oni: upper legs are powerfully built, lower legs a bit thin. Feet have two large, clawed toes. 6D6+10 speed attribute.
- 51-60 Skeletal shaped legs with the classic two-toed, clawed feet. 6D6 speed attribute.
- 61-70 Bird-like, spindly, stick legs and clawed bird feet. 6D6 speed attribute.
- 71-80 Human feet with clawed toes. 6D6 speed attribute.
- 81-90 Animal-like; hover or like bear. 6D6 speed attribute.
- 91-00 No feet or legs, snail-like trunk; slithers. 3D6 speed attribute; +4 to maintain balance.

### Other Features

- 01-07 Tail of a rat.
- 08-14 Skin is covered with tiny scales. Add 35 to M.D.C.
- 15-21 Pair of small horns. 1D4 M.D. from head butts.
- 22-28 Pair of large horns. 2D6 M.D. from head butts.
- 29-35 Large mane of hair, black, red, gold or green in color.



- 36-42 Bushy eyebrows and a scraggly beard.  
 43-49 Lumpy pink or white flesh. Add 10 to M.D.C.  
 50-56 Hairy body with tan or red skin. Add 20 to M.D.C.  
 57-64 No hair on the body; pale skin.  
 65-72 Boils or scabs cover the body. Add 25 to M.D.C.  
 73-80 Pot belly, but otherwise muscular. Add 10 to M.D.C.  
 81-87 Hunchback. Add 5 to M.D.C.  
 88-94 Tail of a lizard.  
 95-00 Covered in fur. Add 10 to M.D.C.

### Skin Color

- |                         |                            |
|-------------------------|----------------------------|
| 01-10 Brown or Tan      | 51-60 Jade Green           |
| 11-20 Reddish Brown     | 61-70 Light Blue           |
| 21-30 Light or Dark Red | 71-80 Pale Grey            |
| 31-40 Fiery Red         | 81-90 Stark White or Ivory |
| 41-50 Light Green       | 91-00 Mustard/Yellow Brown |



## Oni of the One Hundred (Lesser Oni)

**Note:** These characters are primarily NPC villains. The use of an Oni of the One Hundred is entirely left to the G.M.'s discretion. If a player character, the creature is likely to be an outcast for one reason or another, possibly because of an anarchist, unprincipled or scrupulous alignment.

**Alignments:** 45% miscreant, 30% diabolic, 5% aberrant, 15% anarchist and 5% other.

**Attributes:** I.Q. 2D6, M.E. 2D6, M.A. 2D6, P.S. 22+2D6, P.P. 12+2D6, P.E. 16+2D6, P.B. 1D6, Spd: see the feet and leg chart for speed. All attributes are considered supernatural.

**Average Size:** 4 to 5 feet tall (1.2 to 1.5 m)

**Weight:** 100 to 250 pounds (45 to 112.5kg)

**M.D.C.:** 2D6x10+40 M.D. plus possible bonuses from Other Features table.

**Horror Factor:** 11 plus bonus from Head Shape table.

**P.P.E.:** 5D6 for a typical warrior.

**Natural Abilities:** **Nightvision** 500 feet (152 m; can see even in total darkness), fire and cold resistant (half damage), impervious to disease, bio-regenerates 2D6 M.D. per hour.

**Psionics:** None.

**Magic:** There are four sets of powers common to the Oni of the One Hundred. These are natural abilities — the creatures don't know spell magic. As many as 8 spells can be cast per 24 hour period. Select one group of the following or roll percentile dice for a random selection:

01-25 Fear, compulsion, luck curse, minor curse, repel animals and tongues.

26-50 Befuddle, blind, sickness, spoil (food & water), animate/control dead, and tongues.

51-75 Globe of daylight, ignite fire, cloud of smoke, fire ball, fool's gold, and tongues.

76-00 Breathe without air, fly as the eagle, wind rush, summon fog, summon storm, and tongues.

**Combat Skills:** Four attacks per melee, plus one at levels 6 and 12.

**Damage:** Restrained claw attack inflicts 5D6 S.D.C. damage plus P.S. bonus, a full strength claw/punch, or kick inflicts 3D6 M.D., gore with horns inflicts 2D6+6 M.D., power punch does 6D6 M.D., but counts as two attacks, leap kick does 1D4x10M.D., but counts as two attacks, or a body flip/throw which inflicts 2D6 M.D.

**Bonuses:** In addition to physical attribute bonuses, +1 on initiative, +2 to strike, parry and dodge, +2 to pull punch, +1 to roll with punch/fall/impact, and +6 to save vs horror factor.

**R.C.C. Skills:** Very limited; intelligence (+4%), track humanoids (+10%), land navigation (+15%), climb (+10%), swim (+10%), W.P. blunt, W.P. sword and two of choice (any), speak Japanese, Gobblely and Faerie at 98% and can learn two other languages (+10%).

**Secondary Skills:** The character also gets to select four secondary skills from the following categories: espionage, physical, technical, rogue, and wilderness. These are additional areas of knowledge that start at the base skill level.

**Average Life Span:** 250+ years

**Average Experience Level:** The average NPC warrior will be third level. Elite warriors 1D4+2 level, and war chief/clan leader 1D4+4 level.

**Habitat:** Found primarily on the islands of Japan, Taiwan, Korea, China and parts of India and Southeast Asia. They have also been known to visit surrounding islands, as far as the Philippines. The oni prefer to inhabit wilderness areas, mountains, slums, sewers and ru-

ins. In Japan, the majority are found in The Zone and the **Freelands**, although small tribes can be found in the backwater areas of the New Empire and, alley ways of the Republic.

**Typical Oni War Band:** The smallest will have **1D6+4**oni, a medium-sized group will have **3D6+12**oni and the largest rarely exceed 80.

**Typical Oni Clan:** Small clans will have 20 to 40 members, the average clan has 80 to 120 members, while the largest ones can number 300 to 500!

**Typical Oni Village:** **3D4x100** oni (inhabited by members of more than one clan), **1D6x10** other supernatural creatures (goblins, imps, faeries, etc.) and/or **1D4x10** human or **D-bee** allies, plus **1D4x100** human and/or **D-bee** slaves.

**Enemies:** Tengu, **yamabushi**, **bishamon**, demon quellers, samurai, **psi-stalkers** and **Atlantean** Undead Slayers are among the oni's few, *ancient*, natural enemies, along with a handful of gods. Faerie folk, elementals, dragons, the **kilin** and other magical creatures are disliked and avoided, mainly because they tend to be more powerful than the insecure demons, and are not automatically regarded as an enemy, just a potential threat. Generally speaking, the Japanese people, humans and **D-bees** all consider the oni to be deadly enemies (although the latter is seen by the oni as inferiors to be conquered and enslaved).

**Allies:** Other oni, other demons, vampires, goblins, goblin spiders, ogres, trolls, gargoyles, goblins, evil dragons, priests, sorcerers, and other powerful forces of evil of all kind. The **Horune** pirates have been trading with these monsters for decades.

---

# Oni Master

---

The oni master is a larger, meaner, more powerful version of the lesser oni. Unlike their smaller, more skitterish brothers and sisters, the oni master doesn't frighten easily nor do they back down. They tend to be bold, aggressive, wild men who love a challenge, both in physical combat and schemes of manipulation. They hate human warriors and demon hunters and find special delight in fighting and slaying them. However, unlike the insidious oni mystic who engages in sinister and long-term plots, most of these demons tend to be fairly straightforward and face conflict and adversity head on.

Roll up pretty much the same as before, using all the same tables. Be certain to look at the differences in attributes, magic, combat and skills, among others. One in ten oni are oni masters.

## Oni Master

Note: These characters are strictly **NPC** villains.

**Alignments:** Evil or anarchist.

**Attributes:** I.Q. 2D6+6, M.E. 2D6+8, M.A. 2D6, P.S. 28+2D6, P.P. 14+2D6, P.E. 18+2D6, P.B. 1D6, Spd: see the feet and leg chart for speed. All attributes are considered supernatural.



**Average Size:** 5 to 6 feet tall (1.5 to 1.8 m)

**Weight:** 160 to 250 pounds (72 to 112.5kg)

**M.D.C.:** 3D6×10+100 M.D. plus possible bonuses from Other Features table.

**Horror Factor:** 13 plus bonus from Head Shape table.

**P.P.E.:** P.E. attribute number x4 +10 per level of experience.

**Natural Abilities:** Nightvision 500 feet (152 m; can see even in total darkness), fire and cold resistant (half damage), impervious to possession and disease, bio-regenerates 1D4×10M.D. per hour.

**Psionics:** None.

**Magic:** Oni masters possess one of two possible sets of powers. These are natural abilities — the creatures don't know spell magic. As many as 8 spells can be cast per 24 hour period. Select one group of the following or roll percentile dice for a random selection:

**01-50** Concealment, detect concealment, chameleon, mask of deceit, repel animals, blind, sickness, mute, spoil (food & water), fear, trance, calling, domination, compulsion, cure illness, agony, life drain, luck curse, minor curse, constrain being, banishment, and tongues.

**51-00** Breathe without air, float in air, thunderclap, fly as the eagle, escape, sleep, time slip, **teleport:** lesser, energy disruption, impervious to energy, energy bolt, call lightning, fire ball, wind **rush**, summon fog, summon & control rain, summon storm, and tongues.

**Combat Skills:** Karate or jujitsu.

**Damage:** Restrained claw attack inflicts 6D6 S.D.C. damage plus P.S. bonus, a full strength claw/punch or kick inflicts 4D6 M.D., gore with horns inflicts 2D6+6 M.D., power punch does 1D4×10+8 M.D. but counts as two attacks, leap kick does 1D6×10M.D., but counts as two attacks or a body flip/throw which inflicts 2D6 M.D.

**Bonuses:** In addition to physical attribute bonuses and martial arts training: +2 on initiative, +1 to strike, parry and dodge, +2 to pull punch, +1 to roll with **punch/fall/impact**, +1 to save vs mind control, +8 to save vs horror factor, and +1 additional attack per melee round!

**R.C.C. Skills:** Very limited; intelligence (+4%), track **humanoids** (+10%), land navigation (+15%), climb (+10%), swim (+10%), two rogue or espionage skills of choice, W.P. Spear, W.P. Sword and three of choice (any), speak Japanese, Gobblely and faerie at 98% and can learn two other languages (+10%).

**Secondary Skills:** The character also gets to select six secondary skills from the following categories: espionage, physical, technical, rogue, and wilderness. These are additional areas of knowledge that start at the base skill level.

**Average Life Span:** 300+ years.

**Average Experience Level:** The average NPC master warrior will be 1D4+1 level. Elite warriors 1D4+3 level, and Oni master clan leaders 1D4+6 level.

**Habitat:** Same as lesser oni.

**Enemies:** Same as lesser oni, only with stronger feelings of animosity, hatred and revenge, especially toward demon quellers, **bishamon**, samurai, **Atlantean** Undead Slayers and powerful summoners and practitioners of **magic**.

**Allies:** They'll consider other powerful **oni/demons**, vampires, and evil dragons, priests, sorcerers, and powerful forces of evil as potential allies or even accept them as their leader, but lesser demons and beings of all kind are regarded as potential minions and slaves. A handful of oni masters are members of **Horune** pirate and mercenary teams.

---

# Oni Mystic

---

Oni mystics are demons who possess vast magic powers. These are among the most powerful and dangerous. Oni mystics often lead groups, occasionally armies, of demons against mortal and other enemies. They frequently become tyrants of villages and cities, enslave humans and D-bees and love to lord over lesser beings. These demon kings are extremely possessive of their territories, and will even consider other demons, dragons and supernatural beings as potential enemies unless the creatures acknowledge it as their lord and master or swear an oath of non-aggression.

Oni mystics are the natural-born leaders of the Oni of the One Hundred, because they tend to be among the most powerful, are extremely aggressive and more intelligent than other oni. Only one in fifty oni are born as mystics, distinguished by a third (mystic) eye.

What order that exists in oni society, especially among the largest clans and armies, is often the result of the mystics' leadership and raw power. They are strong leaders and good organizers, with a mind for strategy and tactics.

The oni mystic will frequently set out in the world on its own, with a small group (2D4) of minions; usually an imp or two, an oni master and a few lesser oni. These lone villains often become spies and assassins for hire. Others may become the advisor to tyrant kings or the right-hand man to an evil power. As individual warriors, the oni mystic is a formidable opponent, gifted with greater power and extensive training in the martial arts. The character has a rudimentary knowledge of how to use and maintain human technology. The use of technology has, thus far, been limited to basic items such as radios, **vibro-blades**, energy weapons, rail guns, explosives, body armor and simple vehicles (motorcycles and trucks).

Roll up pretty much the same as before, using all the same tables, except eyes — the mystic has three. Be certain to look at the differences in attributes, magic, psionics, combat and skills, among others. One in fifty oni are oni mystics.

## Oni Mystic

**Alignments:** Typically miscreant or diabolic, but can be any alignment.

**Attributes:** I.Q. 10+2D6, M.E. 16+2D6, M.A. 3D6, P.S. 28+2D6, P.P. 12+2D6, P.E. 12+3D6, P.B. 2D4, Spd: see the feet and leg chart for speed. All attributes are considered supernatural.

**Size:** 6 to 8 feet tall (1.8 to 2.4 m)

**Weight:** 200 to 400 pounds (90 to 180 kg)

**M.D.C.:** 1D4×100+200 M.D., plus possible bonuses from Other Features table.

**Horror Factor:** 14 plus bonus from Head Shape table.

**P.P.E.:** P.E. attribute x6 +12 per level of experience.

**Natural Abilities:** Nightvision 500 feet (152 m; can see even in total darkness), see the invisible, turn invisible at will, fire and cold resistant (half damage), impervious to possession and disease, bio-regenerates 1D4×10M.D. per hour.

**Psionics (powers of the third eye):** I.S.P. 3D4x10 +10 per level. Detect psionics, clairvoyance, mind block, presence sense, see aura, sense magic, telepathy, resist fatigue, resist hunger, bio-manipulation, mind bolt and psi-sword.

**Magic:** Armor of **Ithan**, mystic alarm, apparition, multiple image, mask of deceit, chameleon, fool's gold, escape, fly like the eagle, befuddle, energy bolt, fireball, call lightning, negate magic, metamorphosis: insect, mystic portal, commune with spirits and tongues. Plus one additional spell of choice per level of experience. Selections can be made from spell levels 1-10.



**Mystic Martial Arts Powers:** Select one art of invisibility at levels one and four, select one body hardening exercise at level 8, and one zen-joriki power at level 12!

**Combat Skills:** Karate, kendo or jujitsu.

**Damage:** Restrained claw attack inflicts 6D6 S.D.C. damage plus P.S. bonus, a full strength claw/punch or kick inflicts 4D6 M.D., gore with horns inflicts 2D6+6 M.D., power punch does 1D4×10+8 M.D. but counts as two attacks, leap kick does 1D6×10M.D., but counts as two attacks, or a body flip/throw which inflicts 2D6 M.D.

**Bonuses:** In addition to physical attribute bonuses and martial arts training: +2 on initiative, +1 to strike, parry and dodge, +2 to pull punch, +1 to roll with **punch/fall/impact**, +1 to save vs mind control, +8 to save vs horror factor, and +1 additional attack per melee round!

**R.C.C. Skills:** Detect ambush (+15%), detect concealment (+10%), calligraphy (+10%), forgery (+10%), go (+10%), intelligence (+14%), imitate voice (+8%), track **humanoids** (+15%), land navigation (+15%), wilderness survival (+15%), first aid (+5%), camouflage (+5%), prowl (+15%), climb (+10%), swim (+10%), W.P. Sword, W.P. modern weapon of choice, and two of choice (any), speaks Japanese Gobblely and Faerie at 98% and can learn two other languages (+10%).

**Secondary Skills:** The character also gets to select a total of three secondary skills from the following categories: espionage, physical, technical, rogue, and wilderness. These are additional areas of knowledge that start at the base skill level.

**Average Life Span:** 300+ years.

**Average Experience Level:** The average NPC mystic will be 1D4+1 level. Mid-level mystics 1D4+3 level, and mystic war chief/clan leader 1D4+6 level.

**Habitat:** Same as lesser oni.

**Enemies:** Same as lesser oni, only with stronger feelings of animosity, hatred and revenge, especially toward demon quellers, **bishamon**, samurai, **Atlantean** Undead Slayers and powerful summoners and practitioners of magic.

**Allies:** In their quest to enslave humanity, the oni mystics readily form alliances with all creatures of evil, especially powerful supernatural beings like dragons and dark gods. They also frequently associate with evil sorcerers, tyrant kings and cruel people of power. Oni mystics do not trust Goblin Spiders but enlist their aid anyway for their natural skills at spying and assassination.

## Sura-Kappa

Sura-kappa are small, monkey-like creatures who inhabit the rivers, lakes and coastal areas of Japan. These D-Bees visited Earth in the days of antiquity but were banished along with the oni, dragons and other monsters by the Japanese gods. Since the Coming of the Rifts, the sura-kappa have returned and populate the majority of the coastal areas in the Sea of Japan and East China sea. The majority of sura-kappa have no desire to wipe out humanity, though a small number are so inclined and occasionally join forces with oni, the Lord of the Deep and other dark forces.

The sura-kappa lead a simple existence, living in small family units that usually number no more than 20, but which can congregate in larger communities that can number into the thousands. They disdain human technology, preferring to live as tribal hunters, preying upon fish and sea animals. They will also attack easy prey along the coast, and infrequently come on dry land to slaughter livestock and hunt the occasional humanoid —travelling as much as 20 miles (32 km) inland, usually traveling along rivers. As a rule, the sura-kappa are civil beings willing to converse with intelligent life forms about a myriad of things.

Sura-kappa have no tolerance for those who would invade their territory. This often includes sailors, pirates, fishermen and unwitting travelers. The angry little sea monkeys will chase away fish, snap fishing

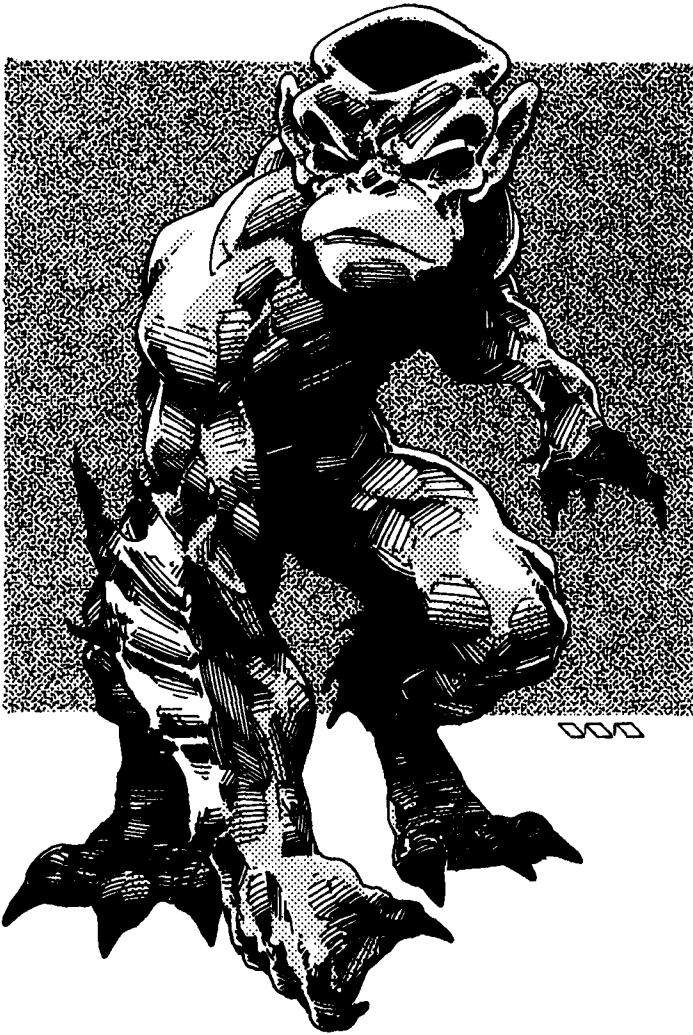

lines, cut nets, and scuttle ships on rocks. If they are really angry they'll sink boats and drown the crew. Most will defend themselves rather than flee, unless their foes are an obviously superior force. This is not to say that kappa are evil, in fact, many clans are honorable people, they just see nothing wrong with the consumption of humanoids or protecting their territories. They have even been known to aid humans from time to time, carrying lost sailors to shore, warning them of underwater predators and coming storms, and even healing the injured.

The greatest weakness of the sura-kappa is the need to constantly be in contact with water. On the top of their heads is a bowl shaped depression to hold water for treks on dry land. If the water is spilled the sura-kappa will immediately collapse, weakened to the point of helplessness. In such a state, the creature can no longer use any of its natural abilities, actions per melee are reduced to one, speed becomes one-tenth of the original value and strength drops to 4. Furthermore, the kappa's mega-damage capacity becomes regular hit points and it becomes vulnerable to regular S.D.C. attacks. Once a sura-kappa is returned to water, it recovers in 5 minutes, regaining all of its original abilities/attributes. The creature will remember its savior and return the favor if it should ever get the opportunity.

### Sura-kappa

**Alignments:** Typically unprincipled or aberrant, but can be any.

**Attributes:** I.Q. 3D6, M.E. 2D6, M.A. 2D6, P.S. 6+3D6, P.P. 2+3D6, P.E. 12+3D6, P.B. 2D6, Spd running, 4D6, swimming 4D6x10. Attributes are considered to be supernatural.

**Size:** 3 feet (0.9 m)

**Weight:** 80 pounds (36 kg)

**M.D.C.:** 2D4x10 M.D.

**Horror Factor:** 10

**P.P.E.:** 6D6+40 and an additional 1D6 P.P.E. per level of experience.

**Natural Abilities:** Nightvision 300 feet (91 m), swim 98%, breathe underwater (and air), immune to the bends, recognize species of fish 80%, cold resistant (half damage), depth tolerance: one mile (1.6 m), healing touch which restores 2D6 hit points/M.D. (can be used once per every five minutes) and can bio-regenerate 2D6 M.D. per minute in water.

**Psionics:** None.

**Ocean Magic** (see *Rifts Underseas*, pg 64-71): Air swim, calm waters, communicate with sea creatures, impervious to ocean depths, ride the waves, weed snare, water seal, water pulse, water rush and water spout.

**Combat Skills:** Four attacks per melee round or two by magic.

**Damage:** Restrained claw attack inflicts 3D6 S.D.C. damage plus P.S. bonus, a full strength claw/punch, or kick inflicts 1D6 M.D., power punch does 2D6 M.D., but counts as two attacks, and bite which inflicts 1D4 M.D.

**Bonuses:** In addition to physical attribute bonuses, +1 on initiative, +1 to strike, +2 to parry and dodge, +4 to roll with punch, +2 to save vs psionics, +5 to save vs horror factor.

**R.C.C. Skills:** Fishing (+20%), wilderness survival (+15%), first aid (+15%), holistic medicine (+10%), prowling (+10%), climb (+10%), W.P. Club, W.P. one of choice (ancient only). Languages include: Faerie Speak (Kappa), Japanese and Gobblely 98%, and can learn one other language (+10%).

**Secondary Skills:** The character also gets to select a total of three secondary skills from the following categories: espionage, physical, technical, rogue, and wilderness. These are additional areas of knowledge that start at the base skill level.

**Average Experience Level:** The average NPC Kappa will be of 1D4+1 level.

**Average Life Span:** 80 to 100 years

**Appearance:** Kappa are short, gangly creatures approximately the size of an eight year old child. They resemble hairless monkeys with greenish-yellow colored skin, webbed hands and feet, and fins on their forearms and legs. There is a bowl-shaped indentation on the crest of their heads, which will be filled with water when the Kappa is on land.

**Habitat:** They can be found scattered here and there throughout the South Pacific, but are most common in the Sea of Japan and the East China sea.

**Enemies:** Any creature that invades sura-kappa territory, or assaults the creatures in any way, will be considered an enemy. They hate the Lord of the Deep and its minions, and dislike the **Horune** pirates, Naut'Yll (see *Rifts Underseas*) and most sea monsters. They are suspicious of the **Lemurians**, **amphibs** and most other intelligent sea life, except for dolphins and other cetaceans.

**Allies:** They have no allies per se, and tend to have little contact outside their family groups.

---

## Goblin

---

### Adapted from *Rifts Conversion Book One*

Next to the Oni, goblins are the most numerous D-Bees in the Japanese islands, which is not surprising since they are known to exist on several worlds, including ancient Earth and Palladium, probably gaining access to them through dimensional rifts at ley line nexuses, or as the minions of a powerful wielder of magic, shifter, summoner, or supernatural being. Goblins are considered to be faerie folk. Despite the kinship, they lack any mystic or innate powers themselves. This may be the

result of evolution or genetic mutation. Only the *cobbler goblin*, one in twenty, possesses faerie-like magic powers.

Goblins are generally mean-spirited, vindictive, and cruel people. The typical goblin society operates on the principle of the strong preying upon the weak, in a shabby, loose-knit tribal unit that can number into the hundreds or thousands. Other dumb and **mean** beings are also typically included among the tribe's members, particularly dull-witted oni, imps, **orcs** and hobgoblins. A warrior chief rules the tribe, assisted by a war chief (second in command) and a shaman or clergy (third in command), along with members of his family and cobblers. Goblins in Japan frequently associate with the oni and other evil creatures of magic, gladly striking out at the larger and handsomer races.

## Goblins

**Alignments:** Any, but lean toward anarchist and evil.

**Attributes:** I.Q. 2D6, M.E. 3D6, M.A. 3D6, P.S. 3D6, P.P. 4D6, P.E. 3D6, P.B. 2D6, Spd 3D6.

**Size:** Three feet (0.9 m) plus 2D6 inches tall (5 to 30 cm).

**Weight:** 60 to 100 pounds (27 to 49 kg).

**Hit Points:** P.E.+1D6 per level of experience.

**S.D.C.:** 10 plus those gained from O.C.C.s and physical skills.

**Natural Armor Rating:** None

**Horror Factor:** None

**P.P.E.:** 6D6 average goblin or 2D8x10 for cobblers.

**Average Experience Level:** 1D6

**Average Life Span:** 80 years

**Natural Abilities (average goblin):** Superior physical prowess, generally low intelligence. **Nightvision** 90 ft (27.4 m); can see in total darkness) and good overall vision and hearing.

**Natural Abilities (cobbler goblin):** The cobbler is a goblin that retains his or her faerie folk powers. To randomly determine whether a goblin is a cobbler, roll percentile dice; a roll of 1-15 indicates a cobbler. A cobbler's most significant power is the ability to metamorphoses, at will, into a small animal. There is no limit to how often metamorphosis can be performed other than as often as once every two minutes, nor how long the animal shape can be maintained. They usually select ominous animals like a rat, toad, raven, black cat, weasel, etc. This makes them perfect spies, thieves and assassins.

They can also cast the following spells twice per day/24 hours: mend wood, wither plants, sense magic, tongues, charm and darkness. All magic spells are equal to a third level mage. New spells cannot be learned. Cobblers also have an aptitude for woodworking and get a +10% bonus in carpentry and boat building.

**Psionics:** Standard, basically same as humans.

**Combat Skills:** Two without any combat training, or those gained from hand to hand combat and/or boxing.

**Bonuses:** Only those gained from attributes, O.C.C., and skill bonuses. Cobblers are +1 to save vs magic.

**O.C.C.S (Rifts):** Many O.C.C.s, except the Coalition, **NGR** or Republic of Japan military, glitter boy, **cyber-doc** or magic. Lean toward city rat, headhunter, wilderness scout, vagabond and vagabond-thief. Note that goblins like cybernetics and bionics.

**Skills of Note:** Speak Gobblely and Faerie Speak at 98%, typically illiterate. Add a bonus of +2% to rogue/thief skills.

**Habitat:** There are thousands (perhaps tens of thousands) establishing lairs in the mountains of The Zone, the **Freelands** and the island of Hokkaido, the Domain of the Gods. Only a thousand or so are known to exist in North America, mostly in and around Calgary and Windsor. But tens of thousands plague Europe, especially the eastern countries; they are also found in the hundreds throughout Asia.

**Enemies:** Traditionally, humans, elves, dwarves, gnomes and most large and **handsome/beautiful** beings. Even though they are called winged mountain goblins, tengu are generally disliked by real goblins because of their size and comparative beauty and power. Samurai, warrior monks and demon **quellers** are also on the top of the **goblin's** black list. The majority of goblins hate the Republic of Japan and the New Empire because both are considered the enemies of The Zone.

**Allies:** Traditionally, **orcs**, hobgoblins, trolls and wolves. In Japan, they associate with oni, imps and the infamous goblin spiders, evil practitioners of magic and supernatural beings.

**Notes:** Goblins tend to be **impudent**, malevolent, and cruel toward other creatures. They love **vibro-blades** and energy weapons.

---

## Goblin Spider

---

Goblin spiders are evil, shape-changing creatures that revel in the suffering and murder of other creatures. The hideous spider-things actually get a perverse pleasure in torturing and killing other beings. A pleasure akin to the warm buzz a junkie gets when he's high — an intoxicating and palpable delight. As a result, they are infamous torturers, assassins and mass murderers. For this reason, a thousand years ago, these malignant beings were banished from their homeworld for acts of wholesale slaughter and extreme evil. It seems that when goblin spiders settle in someplace where they feel comfortable, they start to murder the lesser inhabitants (killing powerful beings is a tremendous joy, but the task is so much more difficult and dangerous). On their homeworld, they had actually conquered and enslaved entire continents and then methodically began to slaughter the people one by one. This continued for decades, until the skeletons of the millions of dead created mountains of bones and bodies around their citadels. Thankfully, some True **Atlanteans**, with the aid of several gods of light, were able to destroy 80% of the monsters and magically banished the rest to another dimension (roughly one million).

Their numbers badly diminished, and without a home, they became dimensional travelers where they have crossed paths with the **Splugorth**, **Splugorth** minions, temporal raiders/wizards, and more True Atlanteans. True Atlanteans have become something of a hobby for the goblin spiders. The creatures have been following the Atlanteans and studying them for nearly a thousand years, in hopes of uncovering their many secrets of magic and dimensional travel. Some goblin spiders even suspect that the Sunaj are True Atlanteans, and have assisted the Sunaj in secretly hunting down and slaughtering a few hundred **Atlantean** clansmen. They have followed them to Earth because True Atlanteans seem to have a special fondness for the planet. The fact that Earth is a dimensional nexus to a thousand other worlds has proven to be a wonderful bonus. The creatures are especially fond of China, Japan and Asia, and many have settled in these lands.

Over the centuries, they have honed skills of infiltration, sabotage and assassination. In the guise of oni or goblins, they move freely through the Megaverse, causing turmoil, inflicting pain and committing countless atrocities. Some have even used their shape-shifting abilities to infiltrate the Republic of Japan. There they have learned about human technology, which they find fascinating. Some pose as tech-ninja and offer their services as masters of espionage, infiltration, sabotage, interrogation (torture) and assassination. Others skulk around the alleys, run crime rings, or assist at body chop-shops (they love chop-shops). Nobody realizes how many goblin spiders actually inhabit the islands of Japan because they disguise themselves as less frightening creatures (at least 10,000 inhabit Japan; and a hundred times that number live in **China!**).



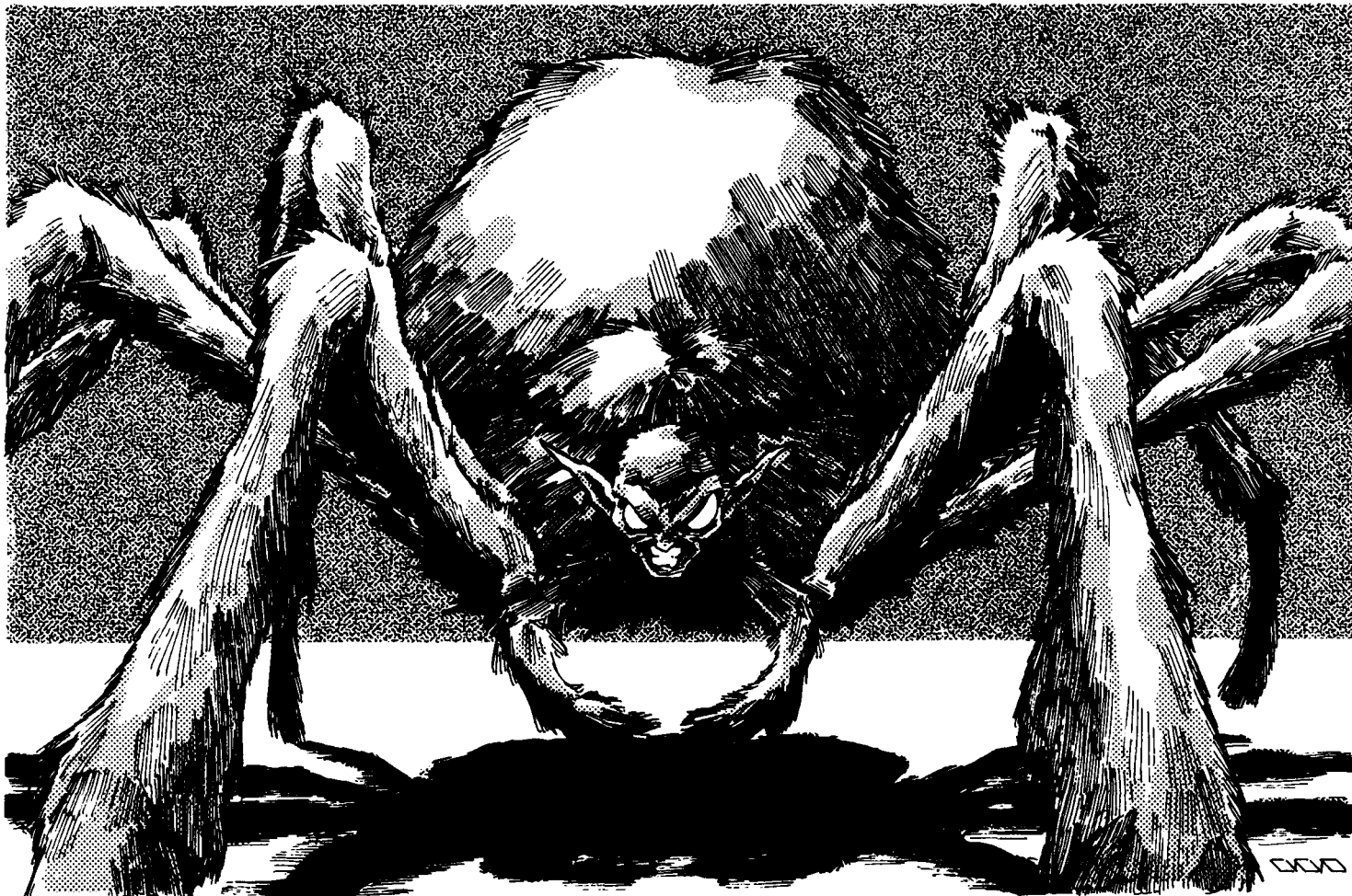

The creature gets its name from the fact that its natural shape is that of a giant, furry spider with eight legs and the head of a goblin, rather than that of an arachnid. Furthermore, the monster can transform into a small humanoid with goblin features (can look exactly like one), or it can alter its diminutive form to look like an imp, hob-goblin, or the classic oni, complete with horns. It can also change its appearance to resemble most of the Oni of the One Hundred's other features, only the most strange and animal-like features are impossible to copy (fish head, snail body, multiple arms, and similar). The spiders insist there is no blood relationship between them and the goblins and that the appearance is pure coincidence.

## Goblin Spiders

**Note:** These characters are strictly NPC villains.

**Alignments:** Diabolic or miscreant.

**Attributes:** I.Q. 3D6+4, M.E. 3D6+4, M.A. 3D6+6, P.S. 3D6+6, P.P. 2D6+12, P.E. 3D6+6, P.B. 1D6 (+4 in humanoid guise), Spd. 4D6x3; running or climbing. All attributes are considered to be supernatural.

**Size:** As a spider: The goblin head in the front of the body is about 4 feet (1.2 m) above the ground but the rest of the body towers to about 9 feet (2.7 m) tall and 12 feet (3.65 m) in length. In humanoid form, the monster looks like a goblin, imp or oni that stands 3 to 5 feet (0.9 to 1.5 m) tall.

**Weight:** 1200 pounds in spider form (540 kg)

M.D.C.: 2D4x100

**Horror Factor:** 16 as a spider, 11 as an oni or imp.

P.P.E.: 1D4x100 plus 2D6 additional P.P.E. points per level of experience.

**Natural Abilities:** Nightvision 1000 feet (305 m), see the invisible, climb like a spider (98%; upside down, on walls and ceilings), prowl

60%, impervious to poison, drugs and disease, and track by blood scent 68% (-38% to recognize the scent of a specific individual) and can follow a trail that is 48 hours old! It can also bio-regenerate 1D4x10 M.D.C. every five minutes and can regenerate lost limbs within 48 hours.

**Limited Metamorphosis:** The horrible thing can shape-change into the form of a goblin, hob-goblin, imp or classic oni (with some modification). This means it can often pass itself off as being a much less threatening creature. With the proper attire, and some alterations of the face and anatomy, the goblin spider can pass himself off as a small D-bee or even a human being. The ninja cover is the perfect disguise since the face, head and body are entirely covered. Likewise, most full suits of body armor and hooded robes do the trick as well. The creature can maintain its humanoid form as long as is desired — hours, days, weeks, years. It can change its appearance at will. The complete transformation takes about one minute (4 melee rounds).

**Lethal Venom:** The bite of the goblin spider inflicts a lethal poison whether the creature is in humanoid or spider form. The bite itself does 1D4 M.D. and the venom does 3D6 M.D. and the victim suffers from sharp stabbing pains in the stomach (-2 on all combat rolls and reduce speed and attacks per melee by half). The damage and penalties continue for 2D6 minutes or until magically negated. This means the bite is deadly to humans and other S.D.C. creatures. However, the goblin spiders hate to do "quick kills," preferring to torture its prey. Most use the bite for serious combat against other mega-damage creatures and for assassinations.

**Lethal Blood:** The same venomous substance courses through the spider's veins, so any creature who bites it and draws blood, or who



drinks its blood, suffers the same damage and penalties as above.

**Webbing:** As a demonic spider, it can cast webs. The webbing is secreted from its rear abdomen and has the strength and light weight of high-tech material. Test weight on a single strand the thickness of kite string is 2400 pounds (1080 kg). It uses the webbing mainly to climb, but it can also create a giant spider's web (takes 10 minutes) or to make snares and traps. Note that this webbing is only slightly sticky.

**Vulnerabilities:** Fire does double damage.

**Psionics:** I.S.P. is 2D4x10 +7 per level of experience (considered a major psionic). Powers are limited to object read, telepathy, death trance, empathy, empathic transmission, bio-manipulation, and mind block.

**Magic:** Most goblin spiders are ley line walkers with an emphasis on dimension magic, or temporal wizards (again, dimensional magic). All know dimensional portal, close Rift, mystic portal, shadow meld, eyes of Thoth, tongues and time slip, plus 10 other spells of choice from any levels of spell magic or temporal wizardry.

**Combat Skills:** Four physical or psionic attacks per melee or two by magic. The goblin spider doesn't waste its time on learning martial arts.

**Damage:** Bite 1D4 M.D. plus venom, 3D6 S.D.C. from a restrained claw/punch plus P.S. bonus, 1D6 M.D. on a full strength claw/punch or kick, and a power punch does 2D6 M.D. (but counts as two attacks). Applicable to both goblin and spider form.

**Bonuses:** In addition to physical attribute bonuses, +2 on initiative, +2 to strike, +2 to parry (+4 to parry as a giant spider), +3 to dodge, +2 to roll with **punch/fall/impact**, +6 to pull punch, +10 to save vs horror factor, +2 to save vs magic, and +5 to save vs possession.

**R.C.C. Skills:** Radio: basic (+5%), intelligence (+16%), disguise (+20% via shape change, but can't look completely human), imitate voices/impersonate (+10%), track **humanoids** (+15%), camouflage (+15%), demolitions (+5%), acrobatics, streetwise (+10%), poetry (+10%), literacy and speaks **Dragonese/Elf**, ancient Greek (**Atlantean**) at 98%, literacy and speaks Japanese and Chinese (+20%), W.P. sword, and two W.P. of choice (any). **Note:** Goblin spiders communicate with each other **telepathically** and empathically, as a result, they have no native language.

**Secondary Skills:** The character also gets to select six secondary skills from any category.

**Average Experience Level (NPC):** 1D4 level for the very young (under 800 years), 1D4+3 on average, and 1D6+5 level for experienced ones.

**Average Life Span:** 3000+ years, some have been known to live to the age of 5000!

**Appearance:** A giant, hairy spider with a bloated, goblin-like head with hideously distorted features and fangs.

**Habitat:** Goblin spiders can be found anywhere, but are most common throughout Asia. A dozen have infiltrated the **Splugorth's** Atlantis while a handful of others are out exploring the rest of the world.

**Enemies:** Every mortal life form is seen as a mere pawn to be manipulated and tortured at the spider's whim. Currently their target of choice is humanity, although any creature is fair game. They dislike the **Splugorth** and their minions (the feeling is mutual).

**Allies:** Goblin spiders do not readily form alliances; they tend to be lone-wolves or stick to their own. However, they have been known to work with oni mystics, evil dragons, evil sorcerers, dark gods and godlings, and other powerful supernatural creatures.

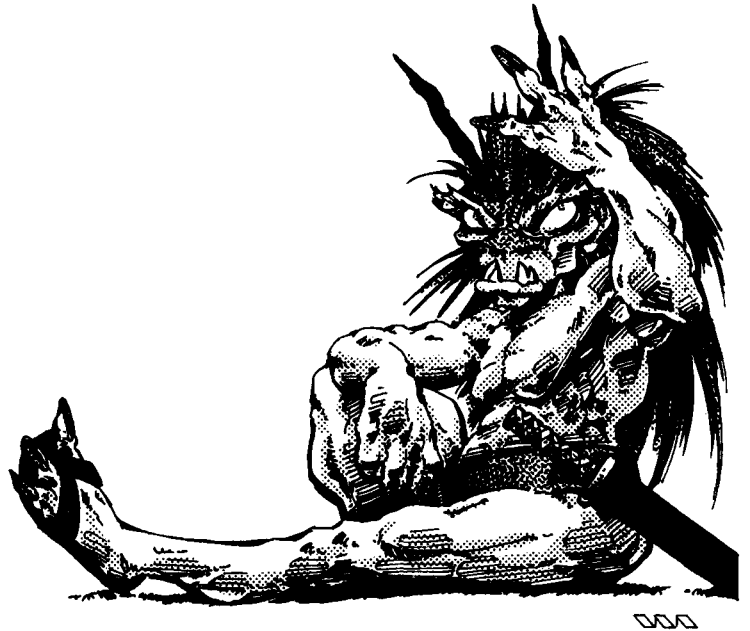

## Japanese Imps

These are tiny demons that resemble miniature versions of the classic oni. Their eyes are large and yellow, a pair of wicked fangs jut from the bottom lip, their scraggly mane of hair is usually crimson or dark green and their skin, light red or tan. They are smarter than the average oni and given to cruel pranks and foul deeds.

They are thieves, spies, kidnappers, stoolpigeons, conniving yes men, and puckish lackeys of the demon world (jobs they all love and excel at). They often seek power and opportunity vicariously through more powerful beings. Consequently, they look for a powerful master to serve; one who can offer plenty of sinister adventures and give the imp a feeling of power and reward. This means they don't care if their master is human, D-bee, dragon, oni or a god-like supernatural being, provided they get their thrills.

### Imps

**Note:** These characters are NPC villains.

**Alignments:** Evil or anarchist.

**Attributes:** I.Q. 2D6+4, M.E. 2D6+4, M.A. 2D6+4, P.S. 2D6+6, P.P. 2D6+8, P.E. 2D6+8, P.B. 1D6, Spd. 2D6+12. All attributes are considered supernatural.

**Average Size:** 3 feet tall (0.9 m)

**Weight:** 50 pounds (22.6 kg)

M.D.C.: 2D4x10+20 M.D.

**Horror Factor:** 9

P.P.E.: P.E.x2 +1D6 per level of experience.

**Natural Abilities:** **Nightvision** 500 feet (152 m; can see even in total darkness), fire and cold resistant (half damage), impervious to disease, bio-regenerates 2D6 M.D. every 10 minutes.

**Vulnerabilities:** Silver weapons inflict their S.D.C. damage as equivalent mega-damage and most cannot swim and are easily drowned.

**Psionics:** None.

**Magic: Mystic Martial Arts Powers:** Select any three *arts of invisibility*.

**Combat Skills:** Three attacks per melee, plus one at level 5 and 11; no formal hand to hand combat abilities.

**Damage:** Bite 1D4 M.D., 2D6 S.D.C. from a restrained claw/punch plus P.S. bonus, 1D4 M.D. on a full strength claw/punch or kick, and a power punch or kick does 2D4 M.D. (but counts as two attacks).

**Bonuses:** In addition to physical attribute bonuses, +2 on initiative, +2 to strike, +1 to parry, 44 to dodge, +1 to pull punch, +2 to roll with **punch/fall/impact**, and +6 to save vs horror factor.

**R.C.C. Skills:** Intelligence (+4%), track **humanoids** (+20%), land navigation (+15%), climb (+10%), palming (+10%), pick locks (+10%), pick pockets (+5%), prowl (+10%), imitate voices (+6%), W.P. knife and one of choice (any); speak Japanese, Gobblely and Faerie at 98% and can learn two other languages (+10%).

**Secondary Skills:** The character also gets to select four secondary skills from the following categories: espionage, physical, technical, rogue, wilderness and W.P. These are additional areas of knowledge that start at the base skill level.

**Average Life Span:** 8000+ years

**Average Experience Level:** The average imp is third level. Elite and experienced imps **1D4+3** level, and ancient imps **1D4+5** level.

**Habitat:** Found primarily on the islands of Japan, Taiwan, Korea, China and parts of India and Southeast Asia. They have also been known to visit surrounding islands, as far as the Philippines. The imps prefer to inhabit wilderness areas, mountains, slums, sewers and ruins. In Japan, the majority are found in **The Zone** and the **Freelands**, although small tribes can be found in the backwater areas of the New Empire and alleyways of the Republic.

**Enemies:** Basically the same as the oni.

**Allies:** Evil and powerful beings looking for a lackey.

---

## Hannya Demon

---

One of the most vile and deadly of the Japanese demons is the *Hannya*, hideous demonic hag with large bulging eyes, crooked yellow teeth, huge misshapen mouth, and clawed hands and feet. The creature is a shape-changer and illusionist, but must show her true appearance before she can strike. The horrible beast feeds on the blood, entrails and P.P.E. of her victims. A terrible coward, she often strikes at the young and the unsuspecting. The **hannya** is especially attracted to handsome young warriors whom she'll beguile with her beauty, get into a deadly embrace and then strike — often tearing at the throat. Thus, she'll disguise herself as a beautiful maiden and appear at crossroads and bridges, waiting for unwitting travelers to fall prey to her bewitching beauty. The malignant demon also preys on priests and monks, pretending to be a grieving widow or victim of molestation. As much scavengers as they are predators, the *hannya* will also stalk the streets and back alleys, preying on the homeless, drunks, runaways and orphan children.

### Hannya Demon

**Note:** These characters are strictly NPC villains and are only female.

**Alignments:** Diabolic

**Attributes:** I.Q. 8, M.E. **2D6+6**, M.A. 1D6 (**1D6+13** in human guise), P.S. 2D6+13, P.P. **2D6+6**, P.E. **2D6+10**, P.B. **1D4** (**20+1D4** in human guise), Spd: **2D6+13** running, or 66 flying (45 mph/72 km). All attributes are considered supernatural.

**Average Size:** 5 to 6 feet tall (1.5 to 1.8 m)

**Weight:** 160 pounds (112.5 kg)

**M.D.C.:** **1D6×10+100**M.D.

**Horror Factor:** 14 in her natural form; zero in human guise.

**P.P.E.:** **1D6×10+60**

**Natural Abilities:** **Nightvision** 500 feet (152 m), fly, turn invisible at will, see the invisible, is impervious to **cold**, poison, drugs, magic poisons and disease, impervious to possession, and bio-regenerates **1D4×10**M.D. per hour.

*Hannya* have strange and amazing recuperative powers: **2D6×10** M.D.C. by the end of every night. If an arm or leg is severed, the monster must get the severed body part and stick it back on at night, so it will rejoin the body and heal by the night's end. If the limb is lost or destroyed by fire, the creature is condemned to live without it and will hunt down and destroy the one(s) responsible. Note that the severed limb does not deteriorate, occasionally twitches, as if alive, and can only be destroyed by being burnt to a cinder.

They can shape change at will into a beautiful (P.B. 20+1D4) human woman. Theoretically, this illusion can be maintained indefinitely, but the *hannya* does not have the patience for elaborate or lengthy games of deception. They shape change for the sole purpose of catching prey. As mentioned previously, the monster must resume her true demonic visage before she can attack — giving alert warriors a chance to dodge, parry or even strike first — the *hannya* is a savage but unskilled fighter.

**Vulnerabilities:** Fire does full damage, silver does mega-damage equal to the S.D.C. damage amount, and magic weapons, including samurai swords, inflict their normal M.D. damage.

**Psionics:** None.

**Magic:** The *hannya* is limited to these natural abilities — the creature doesn't know spell magic and can't teach it or learn new spells. All are equal to a 6th level wizard.

Mask of deceit, repel animals, float in air, thunderclap, escape, and tongues.

**Combat Skills:** Three attacks per melee round, or one by magic.

**Damage:** Restrained claw attack inflicts 4D6 S.D.C. damage plus P.S. bonus, a full strength claw/punch or kick inflicts 2D6 M.D., power punch does 4D6 M.D. but counts as two attacks, leap kick does 5D6 M.D., but counts as two attacks, a restrained bite 4D6 S.D.C., and a full strength bite 1D6 M.D.

**Bonuses:** In addition to physical attribute bonuses: +2 to strike, and parry, +4 to dodge, +2 to pull punch, +1 to roll with **punch/fall/im-**



pact, +3 to save vs psionic attack, +3 to save vs magic, and +5 to save vs horror factor.

**R.C.C. Skills:** Very limited; track **humanoids** (+10%), land navigation (+15%), cook, dance, sing, speak Japanese and Gobblely at 98%.

**Secondary Skills:** None.

**Average Life Span:** 10,000+ years.

**Average Experience Level:** Not applicable. Can be considered the equivalent of 6th level in regard to skills and magic.

**Habitat:** Same as oni.

**Enemies:** Same as oni, only the **hannya** thinks mainly of hunting and feeding rather than acquiring wealth or power.

**Allies:** None per se. Occasionally associate with oni and other creatures of darkness.

## Japanese Dragons



## Shikome Kido-Mi

The words *shikome kido* mean "hideous sorcery" and *mi* "serpent," which aptly describes the dragon that bears this name. The shikome kido-mi is a sinister creature that enjoys tormenting and manipulating humans/mortals for its own personal gain or sheer pleasure. They are foul, conniving beasts who dangle the promise of mystic power and arcane knowledge in front of humans in an attempt to corrupt and control them. These horrible monsters are powerful sorcerers and while they cannot use the mystic martial arts powers themselves, they know them all and are often willing to teach them to their minions and those whom they believe they can corrupt. Of course, one must first *earn* these secrets; a process that involves dark and murderous deeds to the benefit of the dragon, and which is said to "drag the soul into degradation and hell." Some legends suggest that the ninja clans' secret knowledge in the *arts of invisibility* were learned from a shikome kido-mi.

These dragons rarely work with other powerful beings unless it somehow serves their own secret purpose. They are too greedy, de-

**manding**, self-driven and arrogant to concern themselves with the needs of comrades or partners and refuse to acknowledge any being, **man**, dragon or god, as their better, let alone their master.

## Shikome Kido-Mi Dragon

Note: Dragons are ideal for non-player characters and villains. Use the same basic rules for the hatchling R.C.C. as found in the *Rifts RPG* if allowed as a player character.

**Alignments:** Typically miscreant or diabolic, occasionally anarchist or miscreant.

**Attributes:** I.Q. 3D6+10, M.E. 3D6+10, M.A. 3D6+6, P.S. 2D6+32, P.P. 3D6+10, P.E. 3D6+10, P.B. 3D6+10, Spd (running & climbing) 6D6. All attributes are considered to be supernatural.

**Size:** The shikome kido-mi can assume any size from 12 feet (3.6 m) long from snout to tail tip, to their natural full length of 42 feet (12.8 m). When angry, the dragon will stand on its hind legs and tower two-thirds of its current height. If smaller than its full size, an angry shikome kido-mi also tends to double its size without thinking.

**Weight:** One to three tons

M.D.C.: Mature Adult: 2D4×1000+200 (1D4×100+50 for a hatchling, 1D4×1000+800 for a young adult).

**Horror Factor:** 16

P.P.E.: 2D4×100+300 for a mature adult (1D4×100 for a hatchling, 1D6×100+150 for a young adult).

**Natural Abilities:** **Nightvision** 1200 feet (366 m; can see even in total darkness), see the invisible, climbing 98%, prowl 60%, track by blood scent 78%, recognize a creature by scent 68% (-30% to recognize the scent of a specific individual), adjust size from 12 to 42 feet (3.6-12.8 m), turn invisible at will and bio-regenerate 1D4×10 M.D.C. points per minute. The dragon can also dimensionally teleport 88%, and is impervious to cold, poisons, disease, and possession.

**Vulnerabilities:** Weapons made of silver do mega-damage, fire does normal damage and magic weapons, including the living samurai sword, rune weapons and those made from the Millennium Tree, do double damage.

**Psionics:** I.S.P. is 3D6×10. Powers are limited to clairvoyance, see aura, sense magic, sixth sense, telepathy, death trance, automatic mind block defense and hypnotic suggestion.

**Magic:** P.P.E. is 2D4×100. 70% know all spell magic from levels 1-8 plus all dimensional magic spells, sanctum, talisman, amulet, create zombie, and create mummy. 29% know all temporal raider magic (see *Rifts England*) plus all spell magic from levels 1-3 and all dimensional magic spells. 1% know all magic spells from level 1-5 and the secrets of tattoo magic.

40% of these dragons also know how to make select magic items, including *elemental shurikens*, *10,000 strength Nunchaku*, and *magic powders for the Holy Incense Burner*. It uses these items to attract and bribe characters, as well as to get in good with any number of seedy characters or outlaw bands. The creation of these items take months at a time and the Hideous Ones don't enjoy making them, so they do so only when it suits their purpose.

**Mystic Martial Arts Knowledge:** The shikome kido-mi know all the mystic martial arts powers (invisibility, body hardening, and zen-joriki). They *cannot* use these powers themselves but can teach them to characters who serve as their evil minions or who perform a number of special services. Rarely teaches more than three to any one person.

**Combat Skills:** Eight physical attacks per melee round (half if a hatchling, six for young adults) or two by magic.

**Damage:** Bite 6D6 M.D., claw strike 6D6 M.D., punch or kick 5D6 M.D., tail whip 5D6 M.D. power punch 1D6×10; prefer to use magic and magic weapons.

**Bonuses:** In addition to physical attribute bonuses, +3 on initiative, +8 to save vs horror factor, +1 to strike and parry, +2 to dodge and roll with **punch/fall/impact**, and +2 on all saving throws.

**R.C.C. Skills:** Spends most of its time studying magic, but is likely to know the following: palming (+10%), streetwise (+12%), detect concealment (+10%), intelligence (+10%), camouflage (+15%), calligraphy (+10%), forgery (+10%), bonsai (+20%), Go (+10%), Japanese mythology (+20%), demon & monster lore (+20%), W.P. sword, W.P. blunt, and W.P. (any) of choice, as well as speak Japanese, **Dragonese/Elf** and Gobblely 98% and can learn two other languages (+10%).

**Average Level of Experience (NPC):** 1D4+3 for hatchlings and young adults, 2D4+5 for mature adults. Player characters should start as first level hatchlings.

**Average Life Span:** 8000 years.

**Habitat:** Indigenous to an alien dimension. Occasionally found anywhere in the world but seem to prefer Japan, Korea, China, India and Indonesia. They often have mountain retreats, but are known to rule entire villages, or sometimes cities where they'll lord over their subjects from a castle, surrounded by all the riches and luxuries of a king.

**Enemies:** They consider everybody, including other shikome kido-mi and gods as rivals and potential enemies. The demon queller generally includes this dragon among his long list of demons to destroy.

**Allies:** The word "ally" suggests an equal partner or friendship, the shikome kido-mi rarely knows either. At best, the dragon will have an accomplice, but as a rule, has minions, servants, slaves and lackeys who call it master. These minions may include oni, wizards, ninja and others. Occasionally associate with other supernatural beings.

---

## Kumo-Mi

---

Kumo-Mi means "cloud serpent" or "cloud dragon." The dragon gets its name from the fact that it lives high up in the mountains where clouds come to rest, and because of its elemental powers.

Kumo-Mi are like humans; some are incredibly good and kind, others notoriously evil, with most falling somewhere in between. For example, an ancient cloud serpent, known as Natsu Yuki ("Summer Snow"), is one of the guardians of Mount Fuji and a friend to the New Empire. Haku Miyoshi (white grass) is an infamous despot ruler of an oni kingdom in The Zone, with hundreds of human and eta/D-bee slaves.

These dragons are rare compared to the vast number of oni and other supernatural beings walking Japan and China; there are not more than 100 Kumo-Mi throughout the island chain. The serpents have fine scales that are usually white with green accents and jade colored whiskers and fins, or a pale blue color, with green or dark blue fins that run along the spine. The dragon's eyes are like sparkling diamonds, and a pair of long horns crown the head. A single pair of **arms/legs** with razor sharp claws are located toward the front of the body. The rest of its length is long and featureless except for the fin along its back and the smooth, snake-like scales that gleam in the sun and collect morning dew. The **kumo-mi** is a creature of the air and moves through it like an eel through water, slinking and floating effortlessly, rarely touching the ground.

## Kumo-Mi, Cloud Dragon

Note: Dragons are ideal for non-player characters and villains. Use the same basic rules for the hatchling R.C.C. as found in the *Rifts RPG* if allowed as a player character.

**Alignments:** Any; kumo-mi can be good, anarchist or evil.

**Attributes:** I.Q. 3D6+10, M.E. 3D6+10, M.A. 2D6+15, P.S. 2D6+28, P.P. 3D6+8, P.E. 3D6+12, P.B. 3D6+10, Spd. 3D6+88 flying/snaking through the sky (over 55 mph/88 km). All attributes are considered to be supernatural.

**Size:** The kumo-mi can assume any size from 15 feet (4.6 m) long from snout to tail tip, to their natural full length of 60 feet (18.3 m). The cloud dragon usually moves in a fluid, coiled pattern, like an undulating spring.

**Weight:** Four tons

M.D.C.: Mature Adult: 2D4×1000+100 (1D4×100+50 for a hatchling, 1D4×1000+600 for a young adult).

**Horror Factor** (awe): 15

P.P.E.: 1D6×100+200 for a mature adult (1D4×100 for a hatchling, 1D6×100+80 for a young adult).

**Natural Abilities:** Nightvision 1200 feet (366 m; can see even in total darkness), see the invisible, turn invisible at will, climbing 98%,

prowl 60%, adjust size from 15 to 60 feet (4.6-18.3 m), turn invisible at will and bio-regenerate 1D4×10 M.D.C. points per minute. The dragon can also dimensionally teleport 88%, and is impervious to cold, poisons, disease, and possession.

**Vulnerabilities:** Weapons made of silver do mega-damage, and fire and magic weapons do their usual normal damage. Earth elementals inflict double damage.

**Psionics:** I.S.P. is 3D4×10. Powers include all healing abilities plus telepathy, empathy and mind block.

**Magic:** P.P.E. is 1D6×100+200. 50% know all air, illusion and dimensional magic spells from those listed in the *Rifts RPG*, plus tongues,

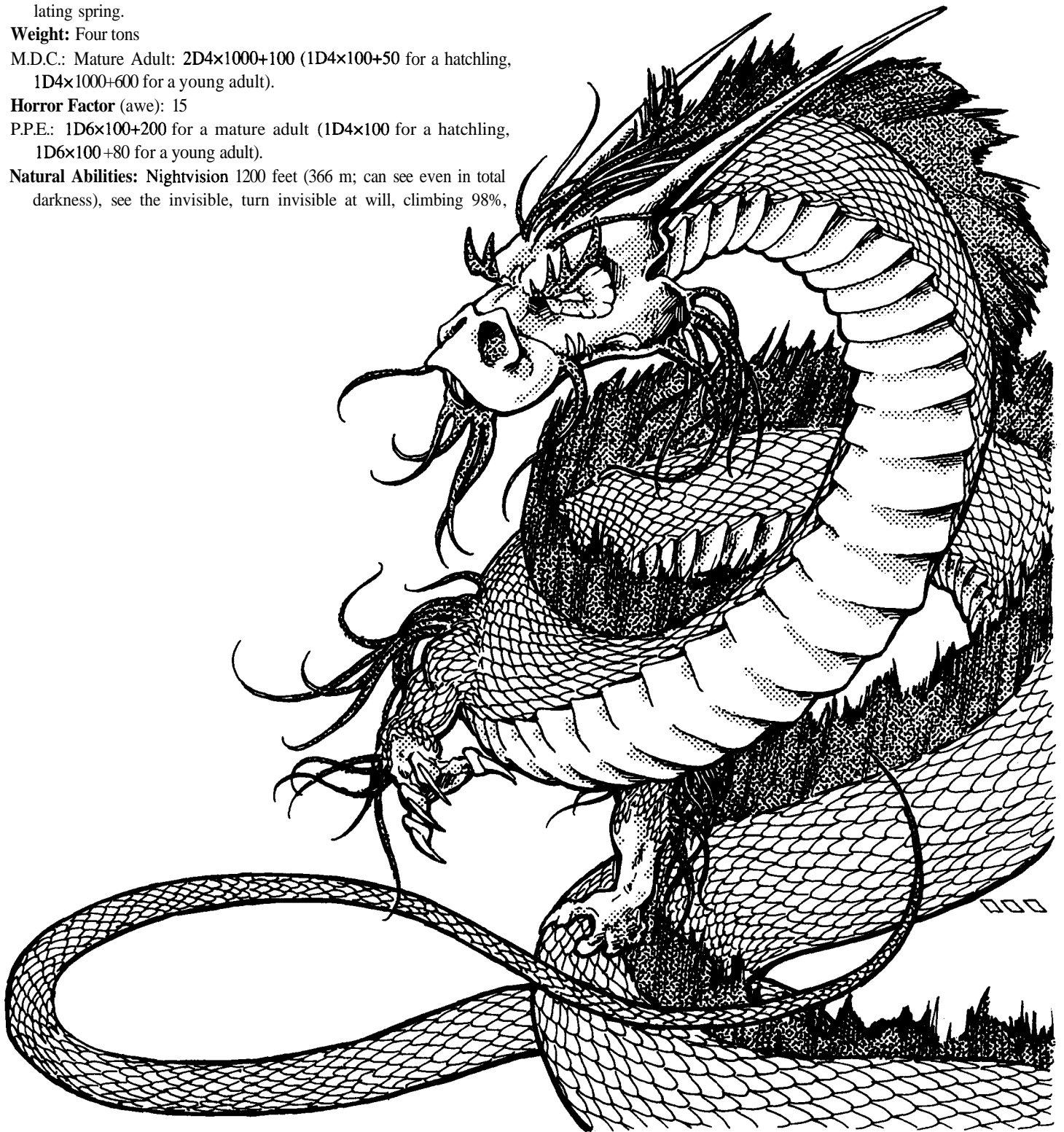

magic pigeon, Eyes of **Thoth**, sanctum, dispel magic, negate magic, anti-magic cloud and both protection circles.

50% know all air warlock spells as presented in *Rifts Conversion Book One*.

**Mystic Martial Arts Knowledge:** Select one *art of invisibility* and one *Zenjoriki power*.

**Combat Skills:** Seven physical or psionic attacks per melee round (four if a hatchling, six for young adults) or two by magic.

**Damage:** Bite **5D6** M.D., claw strike **5D6** M.D., punch or kick **5D6** M.D., tail whip **1D4x10** M.D., power punch **1D6x10**; prefers to use magic and magic weapons.

**Bonuses:** In addition to physical attribute bonuses, +3 on initiative, +7 to save vs horror factor, +1 to strike and parry, +4 to dodge and +3 to roll with **punch/fall/impact**, and +2 on all saving throws.

**R.C.C. Skills:** Only scholarly pursuits: All technical skills (includes all lores, languages and literacy), except computers and photography, all at +10%. The character also knows basic math (+10%), calligraphy, land navigation, identify plants and fruits, gardening, dance, sing, and play wind instruments (flutes and horns).

**Average Level of Experience (NPC):** **1D4+2** for hatchlings and young adults, **2D4+4** for mature adults. Player characters should start as first level hatchlings.

**Average Life Span:** 8000+ years.

**Habitat:** Indigenous to an alien dimension. Occasionally found anywhere in the world but seem to prefer Japan, Korea, China, India and Indonesia. They often have mountain retreats, but are known to rule entire villages, or sometimes cities where they'll lord over their subjects from a castle, surrounded by all the riches and luxuries of a king.

**Enemies:** Often clash with **elementals** and power-hungry creatures of magic and supernatural beings.

**Allies:** Varies with the alignment, temperament and goals of the dragon. Some are friendly and kind toward humans, others aloof, and others cruel and controlling. Most are attracted to other intelligent, trustworthy beings and practitioners of magic. The **kumo-mi** tend to avoid other dragons.

---

## Asama-Tatsu

---

The name **asama-tatsu** translates into "volcano dragon." This is probably because the creature is impervious to fire, has an explosive temper when pushed too far, and is reputed to live inside **volcanos** to avoid being pestered by humans seeking to acquire its great knowledge.

The **asama-tatsu** is huge, standing 20 feet (6 m) tall from the top of its head to the bottom of its front feet, and measuring 100 feet long (30.5 m). Its scales seem to be made of gold (they aren't), eyes are silver, and the head is crowned with a golden unicorn horn and a mane of golden-red hair. The long, fiber-like fins that run down its spine are a dark crimson or black with hints of red.

Like most dragons, they can be good or evil, but most are aloof, although a few have been known to join monasteries to help teach the monks.

### Asama-Tatsu/Dragon

**Note:** Dragons are ideal for non-player characters and villains. Use the same basic rules for the hatchling R.C.C. as found in the *Rifts RPG* if allowed as a player character.

**Alignments:** Any; good, anarchist or evil.



**Attributes:** I.Q. 2D6+16, M.E. 2D6+10, M.A. 2D6+10, P.S. 2D6+36, P.P. 2D6+10, P.E. 2D6+16, P.B. 3D6+10, Spd.: 3D6+88 flying/snaking through the sky (over 55 mph/88 km). All attributes are considered to be supernatural.

**Size:** The **asama-tatsu** can assume any size from 15 feet (4.6 m) long from snout to tail tip, to their natural full length of 100 feet (30.5 m).

**Weight:** Twenty two tons

**M.D.C.:** Mature Adult: 2D4×1000+1400 (1D4×100+50 for a hatchling, 1D6×1000+600 for a young adult).

**Horror Factor** (awe): 16

**P.P.E.:** 2D4×100+200 for a mature adult (1D4×100 for a hatchling, 1D6×100+100 for a young adult).

**Natural Abilities:** Nightvision 1200 feet (365 m; can see even in total darkness), see the invisible, impervious to fire and heat (even M.D. plasma and magic fire), impervious to poisons, disease, and possession; climbing 90%, swimming 90%, adjust size from 20 to 100 feet (6-30.5 m) in length, and bio-regenerate 1D4×10 M.D.C. points per minute. The dragon can also dimensionally **teleport** 92% and teleport self 96%.

**Vulnerabilities:** Cold based attacks/magic do double damage, and magic weapons and mega-damage weapons do their usual normal damage.

**Psionics:** I.S.P. is 3D4x10. Powers include all physical abilities plus telepathy, pyrokinesis, mind block auto-defense, and P.P.E. shield.

**Magic:** 50% are ley line walkers who know all spells from levels 1-7, plus an additional 12 spells from levels 8-15.

20% are **diabolists** (see *Rifts Conversion Book One*).

20% are **techno-wizards** and know all spells from levels 1-5, plus six of choice from higher levels.

10% are alchemists (NPCs) who can create all the items listed in the magic section except for rune weapons.

**Mystic Martial Arts Knowledge:** Select one *Zenjoriki* power at levels 2, 7, 12, and 20.

**Combat Skills:** Seven physical or psionic attacks per melee round (four if a hatchling, six for young adults) or two by magic.

**Damage:** 6D6 S.D.C. on a restrained punch, 5D6 M.D. for a full strength punch/claw strike, 1D6×10 M.D. on a power punch, a bite does 6D6 M.D., and a tail whip 1D6×10 M.D.; prefers to use magic but can fight like a tsunami when angry or fighting for its life.

**Bonuses:** In addition to physical attribute bonuses, +4 on initiative, +8 to save vs horror factor, +2 to strike and parry, +2 to dodge and roll with **punch/fall/impact**, and +2 on all saving throws. Also see natural abilities.

**R.C.C. Skills:** Only scholarly pursuits: All science and technical skills, including computers, and all pilot related skills or medical and herbal skills; all skills are +20%.

**Average Level of Experience** (NPC): 1D4+2 for hatchlings and young adults, 2D4+5 for mature adults. Player characters should start as first level hatchlings.

**Average Life Span:** 8000+ years.

**Habitat:** Indigenous to an alien dimension. Occasionally found anywhere in the world but seem to prefer Japan, Korea, China, India and Indonesia. They often have mountain retreats, but are known to rule entire villages, or sometimes cities where they'll lord over their subjects from a castle, surrounded by all the riches and luxuries of a king.

**Enemies:** Often clashes with power-hungry creatures of magic and supernatural beings.

**Allies:** Varies with the alignment, temperament and goals of the dragon. Some are friendly and kind toward humans, others aloof, and others cruel and controlling. Most are loners and tend to avoid other dragons.

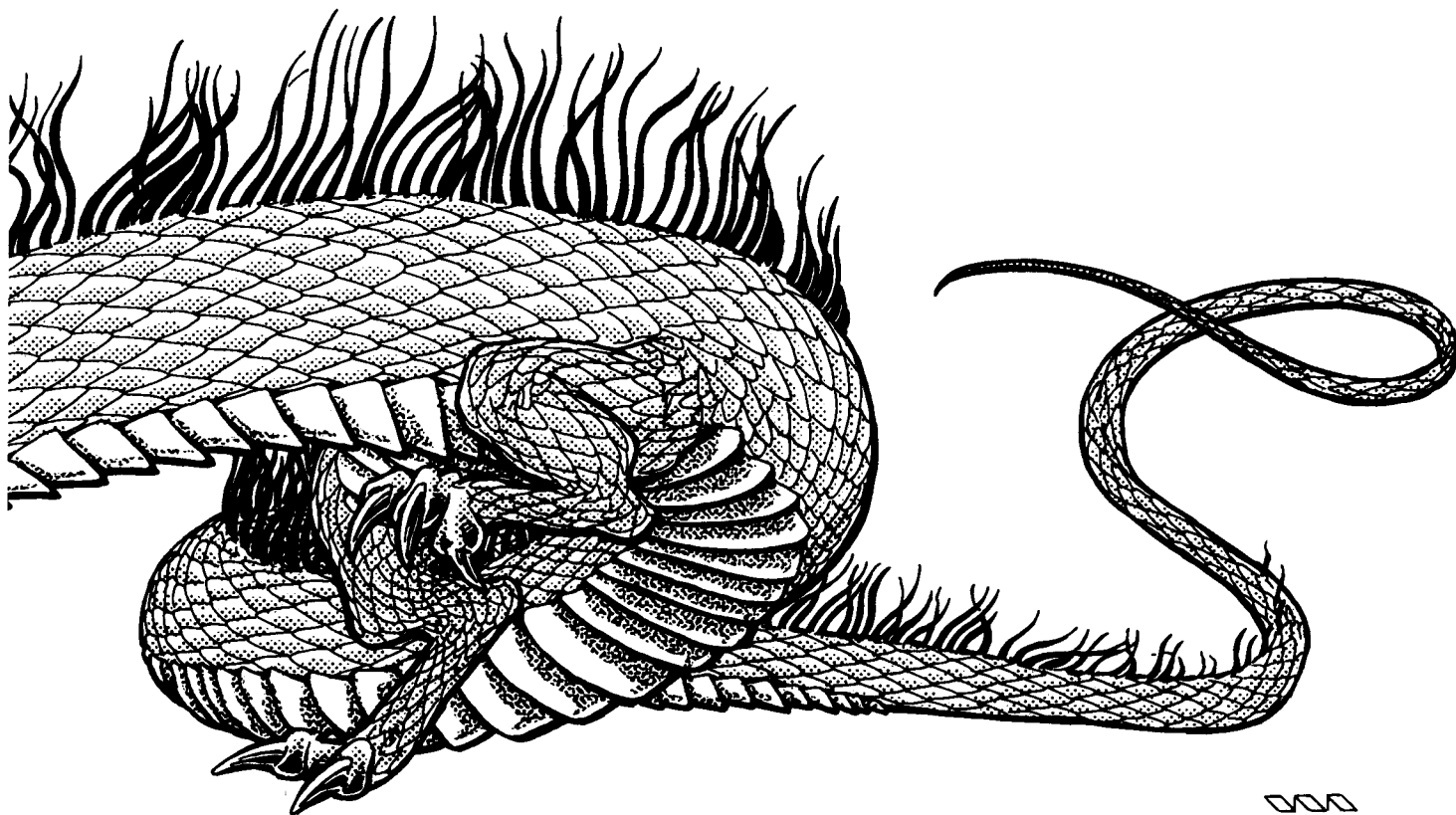



# Experience Point Tables

## Ronin,

### True Samurai

1	0,000-2,150
2	2,151-4,300
3	4,301-8,600
4	8,601-17,200
5	17,201-25,500
6	25,501-36,000
7	36,001-52,000
8	52,001-73,000
9	73,001-98,000
10	98,001-134,000
11	134,001-184,000
12	184,001-240,000
13	240,001-295,000
14	295,001-385,000
15	385,001-450,000

## Bishamon, Fighting Monk

### Sohei, Warrior Monk

1	0,000-2,200
2	2,201-4,400
3	4,401-8,800
4	8,801-17,600
5	17,601-24,000
6	24,001-35,000
7	35,001-50,500
8	50,501-72,500
9	72,501-98,500
10	98,501-140,500
11	140,501-200,500
12	200,501-250,500
13	250,501-325,500
14	325,501-400,500
15	400,501-450,500

## Tech-Ninja,

### Mystic Ninja

1	0,000-2,400
2	2,401-4,600
3	4,601-9,200
4	9,201-18,400
5	18,401-28,300
6	28,301-48,000
7	48,001-78,000
8	78,001-110,000
9	110,001-150,000
10	150,001-200,000
11	200,001-250,000
12	250,001-310,000
13	310,001-380,000
14	380,001-470,000
15	470,001-600,000

## SAMAS Samurai Pilot

1	0,000-1,925
2	1,926-3,850
3	3,851-7,450
4	7,451-14,900
5	14,901-21,000
6	21,001-31,000
7	31,001-41,600
8	41,601-53,000
9	53,001-73,000
10	73,001-103,500
11	103,501-139,000
12	139,001-189,000
13	189,001-239,000
14	239,001-289,000
15	289,001-339,000

## Robot Pilot,

### Police Officer

1	0,000-2,120
2	2,121-4,240
3	4,241-8,480
4	8,481-16,960
5	16,961-24,960
6	24,961-34,960
7	34,961-49,960
8	49,961-69,960
9	69,961-94,960
10	94,961-129,960
11	129,961-179,960
12	179,961-229,960
13	229,961-279,960
14	279,961-329,960
15	329,961-389,960

## Cyber-Samurai

1	0,000-2,100
2	2,101-4,200
3	4,201-8,400
4	8,401-17,200
5	17,201-25,400
6	25,401-35,800
7	35,801-51,000
8	51,001-71,200
9	71,201-96,400
10	96,401-131,600
11	131,601-181,800
12	181,801-232,000
13	232,001-282,200
14	282,201-342,400
15	342,401-402,600

## Oni Master,

### Tengu

1	0,000-2,700
2	2,701-5,400
3	5,401-10,800
4	10,801-21,600
5	21,601-31,600
6	31,601-42,800
7	42,801-62,000
8	62,001-90,000
9	90,001-120,000
10	120,001-170,000
11	170,001-220,000
12	220,001-290,000
13	290,001-400,000
14	400,001-500,000
15	500,001-700,000

## Yamabushi,

### Demon Queller

1	0,000-2,500
2	2,501-5,000
3	5,001-10,000
4	10,001-20,000
5	20,001-30,000
6	30,001-50,000
7	50,001-80,000
8	80,001-120,000
9	120,001-160,000
10	160,001-190,000
11	190,001-240,000
12	240,001-300,000
13	300,001-370,000
14	370,001-440,000
15	440,001-510,000

## Ninja Borg,

### Ninja Crazy,

### Ninja Jucier

1	0,000-2,140
2	2,141-4,280
3	4,281-8,560
4	8,561-17,520
5	17,521-25,520
6	25,521-35,520
7	35,521-50,520
8	50,521-71,000
9	71,001-96,100
10	96,101-131,200
11	131,201-181,300
12	181,301-231,400
13	231,401-281,500
14	281,501-341,600
15	341,601-400,700

## Japanese Imp,

### Ninja Techno-Wizard

1	0,000-2,300
2	2,301-4,600
3	4,601-9,200
4	9,201-18,400
5	18,401-26,500
6	26,501-36,600
7	36,601-51,700
8	51,701-74,800
9	74,801-100,900
10	100,901-140,000
11	140,001-193,100
12	193,101-235,200
13	235,201-290,400
14	290,401-350,600
15	350,601-425,800

## Sura-Kappa,

### Oni of the One Hundred

1	0,000-2,000
2	2,001-4,000
3	4,001-8,200
4	8,201-16,400
5	16,401-24,500
6	24,501-34,600
7	34,601-49,700
8	49,701-69,800
9	69,801-94,900
10	94,901-129,000
11	129,001-179,100
12	179,101-229,200
13	229,201-279,300
14	279,301-329,400
15	329,401-389,500

### Glitter Force Trooper

1	0,000-2,200
2	2,201-4,400
3	4,401-8,800
4	8,801-17,600
5	17,601-27,800
6	27,801-37,900
7	37,901-55,100
8	55,101-75,200
9	75,201-100,300
10	100,301-145,500
11	145,501-190,600
12	190,601-245,700
13	245,701-295,800
14	295,801-345,900
15	345,901-415,100

## Cyberoid,

### Republic Infantrymen

1	0,000-1,950
2	1,951-3,900
3	3,901-8,800
4	8,801-17,600
5	17,601-35,600
6	35,601-50,600
7	50,601-70,600
8	70,600-95,600
9	95,601-125,600
10	125,601-175,600
11	175,601-225,600
12	225,601-275,600
13	275,601-325,600
14	325,601-375,600
15	375,601-425,600

## Oni Mystic,

### Goblin Spider

1	0,000-2,600
2	2,601-5,000
3	5,001-10,000
4	10,001-20,000
5	20,001-30,000
6	30,001-50,000
7	50,001-80,000
8	80,001-120,000
9	120,001-170,000
10	170,001-230,000
11	230,001-300,000
12	300,001-380,000
13	380,001-470,000
14	470,001-600,000
15	600,000-800,000

## Dragon Borg,

### Japanese Borg

1	0,000-2,175
2	2,176-4,300
3	4,301-8,400
4	8,401-17,500
5	17,501-24,600
6	24,601-36,700
7	36,701-44,800
8	44,801-57,900
9	57,901-94,000
10	94,001-130,000
11	130,001-190,000
12	190,001-240,000
13	240,001-280,000
14	280,001-330,000
15	330,001-400,000

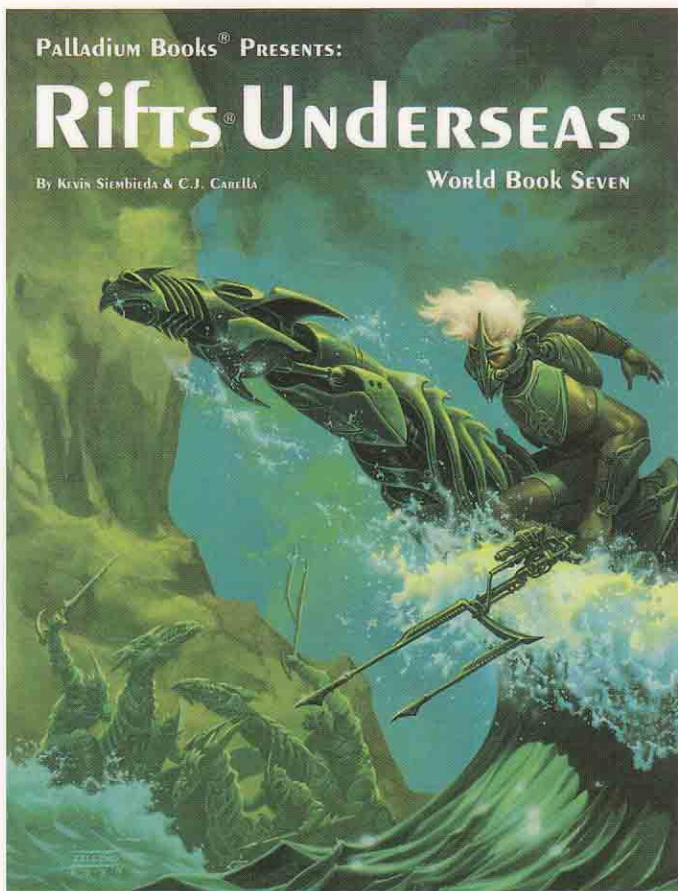

## Also from Palladium Books®

### World Book Seven: Rifts Undersea™

A world of adventure above and below the sea unlike any you could imagine. By Kevin Siembieda and C.J. Carella.

- 10 O.C.C.s including Marines, Ocean Wizards, Sea Druid, Sea Inquisitor, and the Salvage Expert.
- 20 R.C.C.s including the Whale Singer, Sea Titan, Amphib, Dolphins, Horune Pirates, Mutants, D-bees and others.
- Over 40 ocean magic spells, 20 whale songs, plus dolphin magic.
- Underwater bionics, power armor and weaponry.
- Submarines, submersible aircraft carriers, mini-sub, aircraft, robots and more.
- Tritonia, the New Navy, and other kingdoms, each with its unique history, technology, and O.C.C.s.
- The Lord of the Deep and his terrible minions.
- More on Triax™, Atlantis and other places.
- Gene-Splicer™ creations, ley line mutants, Dead Pools, and an entire world of adventure as strange and wondrous as any alien world awaits you in Rifts® Underseas!
- 224 pages — \$19.95

Explore the entire

Palladium Books® Megaverse®!

## Palladium Books® Presents:

# Rifts® Japan

- 20 O.C.C.s including the Samurai, Cyber-Samurai, Mystic Ninja, Warrior Monks, Tengu Winged Goblins, Ninja Juicer, Ninja Crazy, Cyberoid, Demon Queller and Dragon Cyborgs.
- Three new Glitter Boys, winged power armor, spy armor, robots, weapons and more.
- New bionics and cybernetics.
- Martial arts, mystic powers and magic items.
- The “living” samurai swords — minor rune weapons.
- The pre-Rifts super-science and weapons of the Republic of Japan. Four cities from before the Coming of the Rifts!
- The anti-technologists of the New Empires.
- Oni, supernatural monsters and elementals of The Zone.
- More world information about the Coalition States and other places.
- Over 200 pages.

\$20.95

Cat. No. 818

I.S.B.N. 0916211-88-6

ISBN 0-916211-88-6

